

A Genealogy Report For

JOHN LLOYD OF BRUNNANT

Created on 9 April 2012
"The Complete Genealogy Reporter"
© 2006-2011 Nigel Bufton Software
under license to MyHeritage.com Family Tree Builder



CONTENTS

- 1. DESCENDANTS**
- 2. DIRECT RELATIONS**
- 3. FAMILY TREES**
- 4. NOTES**
- 5. INDEX OF PLACES**
- 6. INDEX OF DATES**
- 7. INDEX OF INDIVIDUALS**

A Genealogy Report

General Notes

1. **Sources:** The primary sources of information for births, marriages and deaths up to 2005 are the public record held at Hayes in Middlesex, supported by Census information between 1841 and 1911.
 - a. About the 1841 census
 - i. The 1841 census is the first modern UK census, when the first Registrar General of England and Wales was made responsible for organising the count.
 - ii. This is the earliest census that has survived in its entirety: only local fragments of the 1801, 1811, 1821 and 1831 censuses survived once the statistical information was collected.
 - iii. In the 1841 Census a policy of rounding down ages was in place.
 - As such people aged:
 - 15-19 were recorded as 15;
 - 20-24 were recorded as 20;
 - 25-29 were recorded as 25;
 - 30-34 were recorded as 30;
 - 35-39 were recorded as 35;
 - iv. 1841 was the first time that the head of each household was given a form to fill in on behalf of everyone in the dwelling on a set day. This system still forms the basis of the method used today.
 - v. The 1841 census was taken on the night of 6 June 1841 and gave the total population as 15,914,000.
 - b. About the 1851 census
 - i. The 1851 census was taken on 30 March and gave the total population as 17,922,768.
 - c. About the 1861 census
 - i. The 1861 census was taken on the night of 7 April 1861 and gave the total population as 20,066,000.
 - d. About the 1871 census
 - i. The 1871 census was taken on the night of 2 April 1871 and gave the total population as 22,723,000.
 - e. About the 1881 census
 - i. The 1881 census was taken on the night of 3 April 1881 and gave the total population as 25,974,000.
 - f. About the 1891 census
 - i. The 1891 census was taken on 5 April and gave the total population as 28,999,725.
 - g. About the 1901 census
 - i. The 1901 census was taken on 31 March and gave the total population as 32,527,843.
 - h. About the 1911 census
 - i. The 1911 census for England and Wales was taken on the night of Sunday 2 April, 1911. The count included all individual households, plus institutions such as prisons, workhouses, naval vessels and merchant vessels, and it also attempted to make an approximate count of the homeless.
2. **Names:** As is well known the spelling of the name in registers and on documents in earlier times was largely dependent upon the competence, whim or perhaps the hearing of the Parish Priest or Clerk concerned; the vagaries of local dialects and the idiosyncrasy of individuals will have added to the number of variant spellings. In any case exactitude in spelling was not highly valued or particularly sought after even in the 18th and early 19th century. The diaries of those who would be considered to be educated people yield a variety of spellings of what might now be considered to be common words, even on the same page. As a consequence, the spelling of names was variable until the surname was finally settled upon.
3. **Dates:** Where dates are recorded as a period, ie “Between Jan 1959 and Mar 1959”, or as a month and year, they relate to the *Date of Registration* as recorded in the Public Records. This can lead to apparently significant discrepancies, for instance if a child is born on Friday 31 March, but not registered until Monday 3 April, the records would show the 2nd Quarter, in some cases this could even affect the year. This applies to the Register only, the Birth Certificate would show the correct date.
4. **Places:** As for dates, and unless known from a reliable source, such as a witness, birth, marriage or death certificate, the places listed are taken from the relevant Public Records, as such they record the Registration District rather than necessarily the actual place.



1. DESCENDANTS

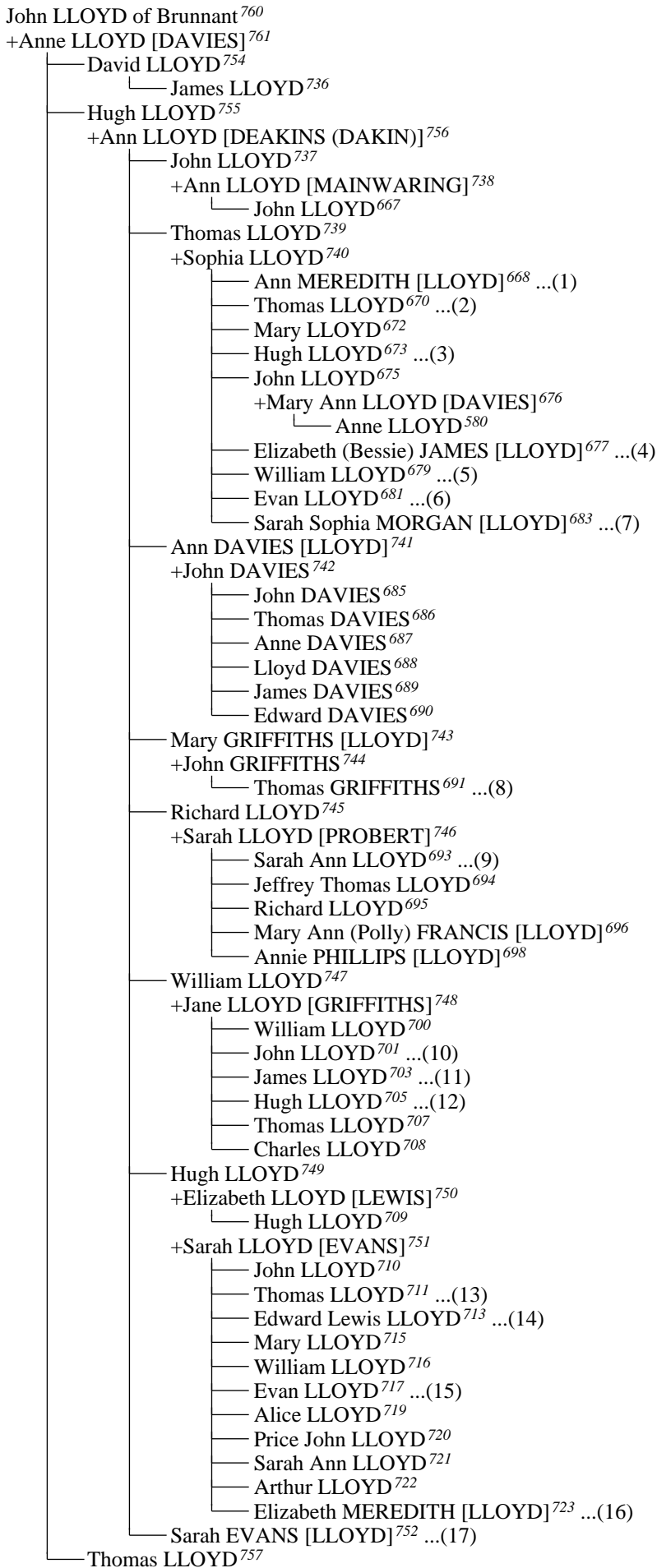

- (1)... Ann MEREDITH [LLOYD]⁶⁶⁸
+Samuel MEREDITH⁶⁶⁹
├— Elizabeth Ann (Eliza) LLOYD [MEREDITH]⁵⁵¹
├— Samuel MEREDITH⁵⁵³
├— Thomas MEREDITH⁵⁵⁴
└— Annie GOODWIN [MEREDITH]⁵⁵⁵

(2)... Thomas LLOYD⁶⁷⁰
 +Margaret LLOYD [CONNOP]⁶⁷¹
 — Hugh Caleb LLOYD⁵⁵⁷
 — James Thomas (Tom) LLOYD⁵⁵⁸
 — Margaret DREW [LLOYD]⁵⁵⁹
 +Edmundd Danzey DREW⁵⁶⁰
 — Edmund DREW³⁹¹
 — Marjorie DREW³⁹²
 — Gladys DREW³⁹³
 — Danzey DREW³⁹⁴
 — Elizabeth Mary DREW³⁹⁵
 — Minnie Sophia DREW³⁹⁶
 — Elizabeth DAVIES [LLOYD]⁵⁶¹
 — Mary Ann (Polly) WILLIAMS [LLOYD]⁵⁶³
 +William WILLIAMS⁵⁶⁴
 — Mary WILLIAMS³⁹⁷
 — John Evan LLOYD⁵⁶⁵
 — Sarah Rosa BYWATER [LLOYD]⁵⁶⁶
 +Richard BYWATER⁵⁶⁷
 — Richard BYWATER³⁹⁸
 +Mary Elizabeth BYWATER [THOMAS]³⁹⁹
 — Richard David BYWATER²¹⁷ ...(18)
 — Darinda M FISHER [BYWATER]²¹⁹
 — Margaret LEWIS [BYWATER]²²¹ ...(19)
 +Phyllis BYWATER [ELLIS]⁴⁰⁰
 — Phyllis Anne BYWATER²²³
 — John Thomas BYWATER²²⁴
 — Daphne BYWATER²²⁵
 — Rosa Mary BYWATER⁴⁰¹
 — Caleb James BYWATER⁴⁰²
 +Doris BYWATER [WATKINS]⁴⁰³
 — John BYWATER²²⁶ ...(20)
 — Ruth JAMES [BYWATER]²²⁸ ...(21)
 — Robin BYWATER BVMS, PhD²³⁰ ...(22)
 — Sally PRICE [BYWATER]²³² ...(23)
 — Adah Margaret BYWATER⁴⁰⁴
 — John (aka Jack) BYWATER⁴⁰⁵
 +Edith BYWATER [DAVIES]⁴⁰⁶
 — John BYWATER²³⁴ ...(24)
 — Rosemary THOMAS [BYWATER]²³⁶ ...(25)
 — Richard BYWATER²³⁸
 — Naomi MORRIS [BYWATER]⁴⁰⁷
 +Ira MORRIS RAF⁴⁰⁸
 — Richard MORRIS²³⁹ ...(26)
 — Thomas BYWATER⁴⁰⁹
 +Ishobel BYWATER [McLELLAN MILLAR]⁴¹⁰
 — Murray Lloyd BYWATER²⁴¹ ...(27)
 — Judith Lloyd CLIFFORD [BYWATER]²⁴³ ...(28)
 — Richard Lloyd BYWATER²⁴⁵ ...(29)
 — Robert David BYWATER⁴¹¹
 +Mary BYWATER [NOTT]⁴¹²
 — John BYWATER²⁴⁸ ...(30)
 — Geoffrey BYWATER²⁵⁰
 — Roger BYWATER²⁵¹
 — Joyce Sarah HARRIS [BYWATER]⁴¹³ ...(31)
 — Constance Minnie DAVIES [BYWATER]⁴¹⁵ ...(32)
 — Ann Sophia ROBERTS [LLOYD]⁵⁶⁸
 +William Owen ROBERTS⁵⁶⁹
 — William Thomas ROBERTS⁴¹⁷ ...(33)
 — Gladys Anne ROBERTS⁴¹⁹
 — James Albert ROBERTS⁴²⁰ ...(34)
 — William Caleb ROBERTS⁴²² ...(35)
 — Ada Agnes BYWATER [LLOYD]⁵⁷⁰
 — Minnie Gladys LLOYD⁵⁷²

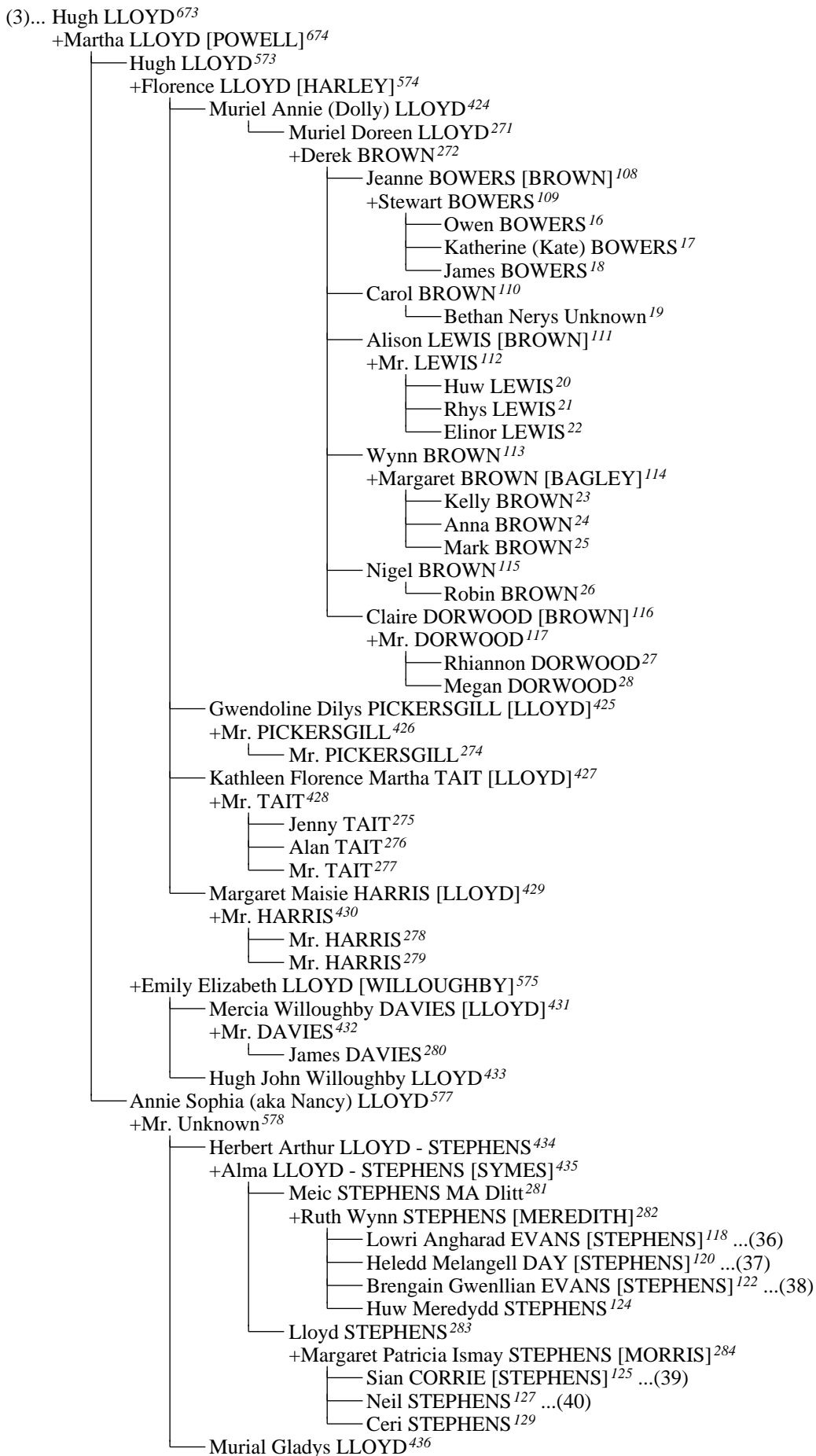

- (4)... Elizabeth (Bessie) JAMES [LLOYD]⁶⁷⁷
 +James JAMES⁶⁷⁸
 └─ Elizabeth Ann (Lizzie) DAVIES [JAMES]⁵⁸¹
- (5)... William LLOYD⁶⁷⁹
 +Sarah LLOYD [MILWARD]⁶⁸⁰
 └─ Adeliza Ann LLOYD⁵⁸³
 └─ William Bayley LLOYD⁵⁸⁴
 └─ Sophia Matilda (Tillie) EVES [LLOYD]⁵⁸⁵
 +Ernest Edward EVES⁵⁸⁶
 └─ Annie Matilda (Nan) PRITCHETT [EVES]⁴³⁷
 +Aubrey PRITCHETT⁴³⁸
 └─ Aubrey E Michael PRITCHETT²⁸⁵ ...(41)
- ─ Elizabeth Anne (Annie) LANE [LLOYD]⁵⁸⁷
 +Thomas LANE⁵⁸⁸
 └─ Tom Evan LANE⁴³⁹
 +Irene LANE [BALLINGER]⁴⁴⁰
 └─ Philip LANE²⁸⁷ ...(42)
 └─ Rachel TURNER [LANE]²⁸⁹
- ─ Alice LLOYD⁵⁸⁹
 └─ Charles LLOYD⁵⁹⁰
 └─ Gladys LLOYD⁵⁹¹
 └─ Hugh LLOYD⁵⁹²
 +Laura LLOYD [KINGS]⁵⁹³
 └─ Laurence Walter Hugh LLOYD RAFVR⁴⁴¹
 └─ Doreen Gladys LLOYD⁴⁴²
 └─ John LLOYD⁴⁴³
 +Beryl Kathryn LLOYD [MILLER]⁴⁴⁴
 └─ David Philip John LLOYD CEng, CITP, MBCS,, MAPM²⁹¹ ...(43)
 └─ Peter Geoffrey LLOYD²⁹³ ...(44)
 └─ Andrew Robert LLOYD RAF²⁹⁵ ...(45)
- ─ Laura Marjorie SINCLAIR [LLOYD]⁴⁴⁵
 └─ Annie Mabel (Nancy) BOWS [LLOYD] BA⁴⁴⁷
 +Raymond George (Bill) BOWS BA⁴⁴⁸
 └─ Kathryn Ann LEWIS [BOWS] BMedSci , BM, BS²⁹⁷ ...(46)
 └─ Richard BOWS RAF (Retd)²⁹⁹ ...(47)
 └─ Charles Edward Lloyd BOWS MA³⁰¹
- ─ David Kingsley LLOYD⁴⁴⁹
 +Susan M LLOYD [MURRAY]⁴⁵⁰
 └─ Hugh David LLOYD³⁰²
 └─ Jacob Kingsley LLOYD³⁰³
 └─ Bethan Laura LLOYD³⁰⁴
 └─ Christine Megan LLOYD⁴⁵¹
- ─ Thomas John LLOYD⁵⁹⁴
 +Catherine LLOYD [JONES]⁵⁹⁵
 └─ Kathleen HARDWICK [LLOYD]⁴⁵²
 +Tom HARDWICK⁴⁵³
 └─ David HARDWICK³⁰⁵
- ─ Evan Sidney LLOYD⁵⁹⁶
 +Mabel LLOYD [KINGS]⁵⁹⁷
 └─ Sidney Walter Gordon LLOYD⁴⁵⁴
 +Peggy LLOYD [SIMMONS]⁴⁵⁵
 └─ Stephen Gareth LLOYD BSc, D.C³⁰⁶ ...(48)
 └─ Peter Adrian LLOYD³⁰⁸ ...(49)
 └─ Heather Joy LLOYD³¹⁰
 └─ Dilys LLOYD⁴⁵⁶
- ─ Sarah Janet STRATTON [LLOYD]⁵⁹⁸
 +Arthur STRATTON⁵⁹⁹
 └─ John Arthur STRATTON⁴⁵⁷
 +Hannah Heslop STRATTON [MACAULAY]⁴⁵⁸
 └─ Christine Elizabeth MENHENNICK [STRATTON]³¹¹
 └─ Bronwen Dorothy STRATTON³¹³ ...(50)
- ─ Edith Megan ROBERTS [STRATTON]⁴⁵⁹
 +Robert Owen ROBERTS⁴⁶⁰
 └─ Gwenllian KNIGHTON [ROBERTS]³¹⁶
 └─ Janet LEWIS [ROBERTS-LEWIS]³¹⁸ ...(51)
- ─ Edith LLOYD⁶⁰⁰

- (6)... Evan LLOYD⁶⁸¹
 +Clara LLOYD [HILL]⁶⁸²
 |— Evan Thomas LLOYD FRSM, MBMA, MRSI⁶⁰¹
 |— Elizabeth Florence LLOYD⁶⁰²
 |— Annie Clara LLOYD⁶⁰³
 |— Ada Marion GITTOES [LLOYD]⁶⁰⁴
- (7)... Sarah Sophia MORGAN [LLOYD]⁶⁸³
 +William MORGAN⁶⁸⁴
 |— Sarah Anne MORGAN⁶⁰⁶
 |— Mary Elizabeth WILLIAMS [MORGAN]⁶⁰⁷
 |— William Thomas MORGAN⁶⁰⁹
 |— Evan John Lloyd MORGAN⁶¹⁰
 |— Edward G MORGAN⁶¹¹
 |— James H MORGAN⁶¹²
- (8)... Thomas GRIFFITHS⁶⁹¹
 +Fortune GRIFFITHS [DAVIES]⁶⁹²
 |— Eva PUGH [GRIFFITHS]⁶¹³
 | +David PUGH⁶¹⁴
 | |— Edward (Eddie) PUGH⁴⁶¹
 | |— Joyce Margaret DAVIES [PUGH]⁴⁶²
 | |— Betty JAMES [PUGH]⁴⁶⁴
 | |— Margaret PUGH⁴⁶⁶
 | |— Ruth POWELL [PUGH]⁴⁶⁷
 | |— Barbara PUGH⁴⁶⁹
 |— Thomas Clement J GRIFFITHS⁶¹⁵
 | +Blanche PEVERILL⁶¹⁶
 | |— Lesley M BASTIN [GRIFFITHS]⁴⁷⁰
 | |— Peter GRIFFITHS⁴⁷²
 | |— Marjorie Sally SMITHERS [GRIFFITHS]⁴⁷³
 | |— Pamela M GRIFFOTHS [GRIFFITHS]⁴⁷⁵
 |— Arthur GRIFFITHS⁶¹⁷
 | +Maud GRIFFITHS [EVANS]⁶¹⁸
 | |— Pamela LEWIS [GRIFFITHS]⁴⁷⁷
- (9)... Sarah Ann LLOYD⁶⁹³
 |— Jane LLOYD⁶¹⁹

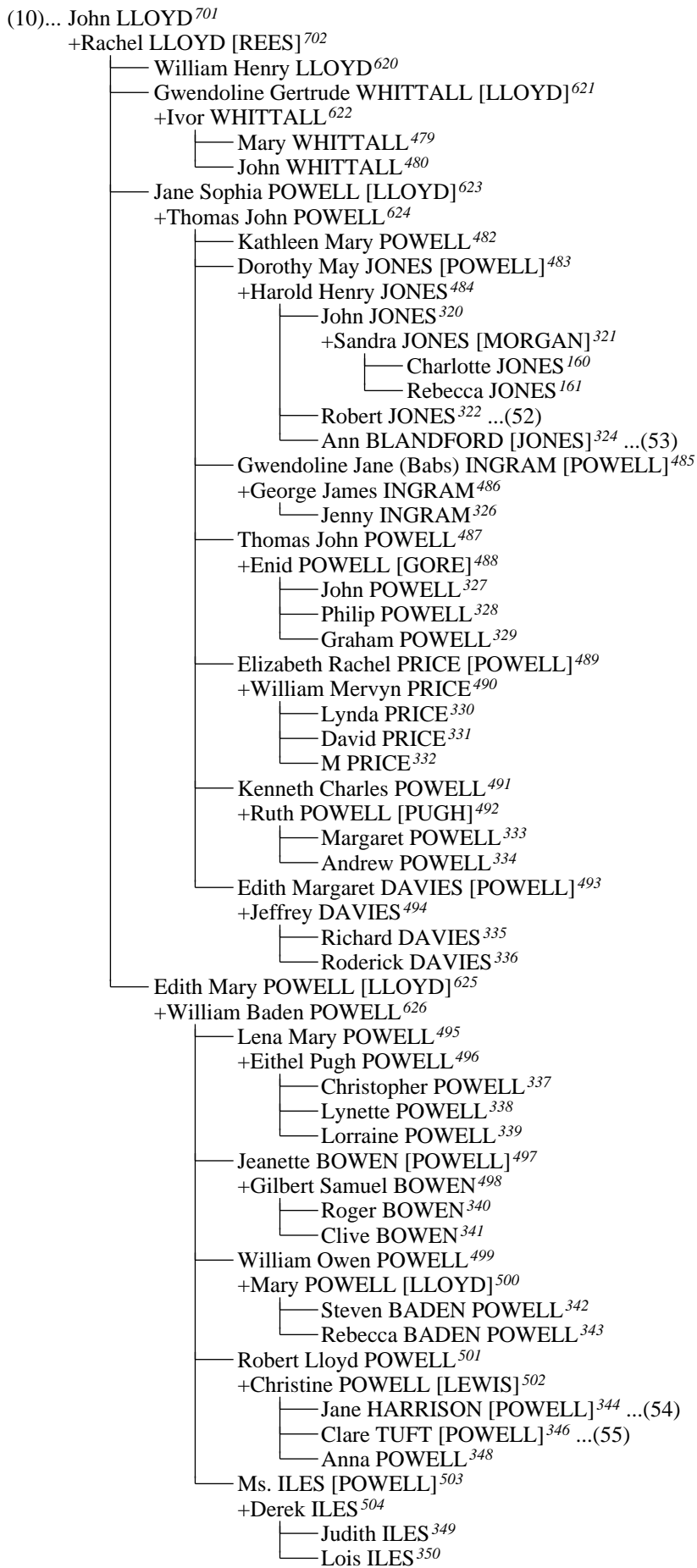

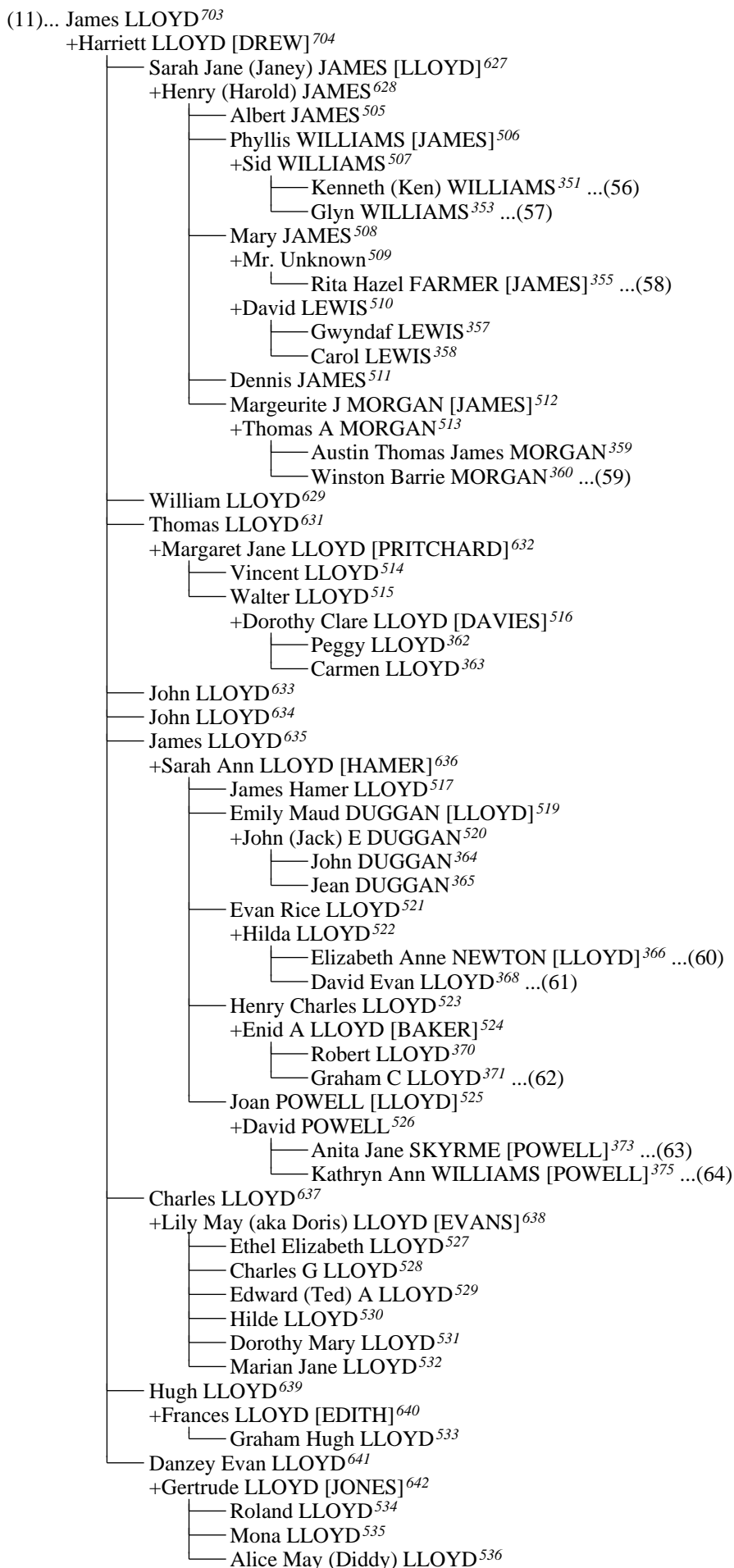

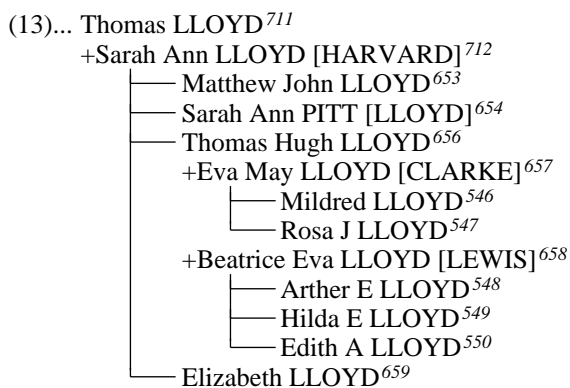
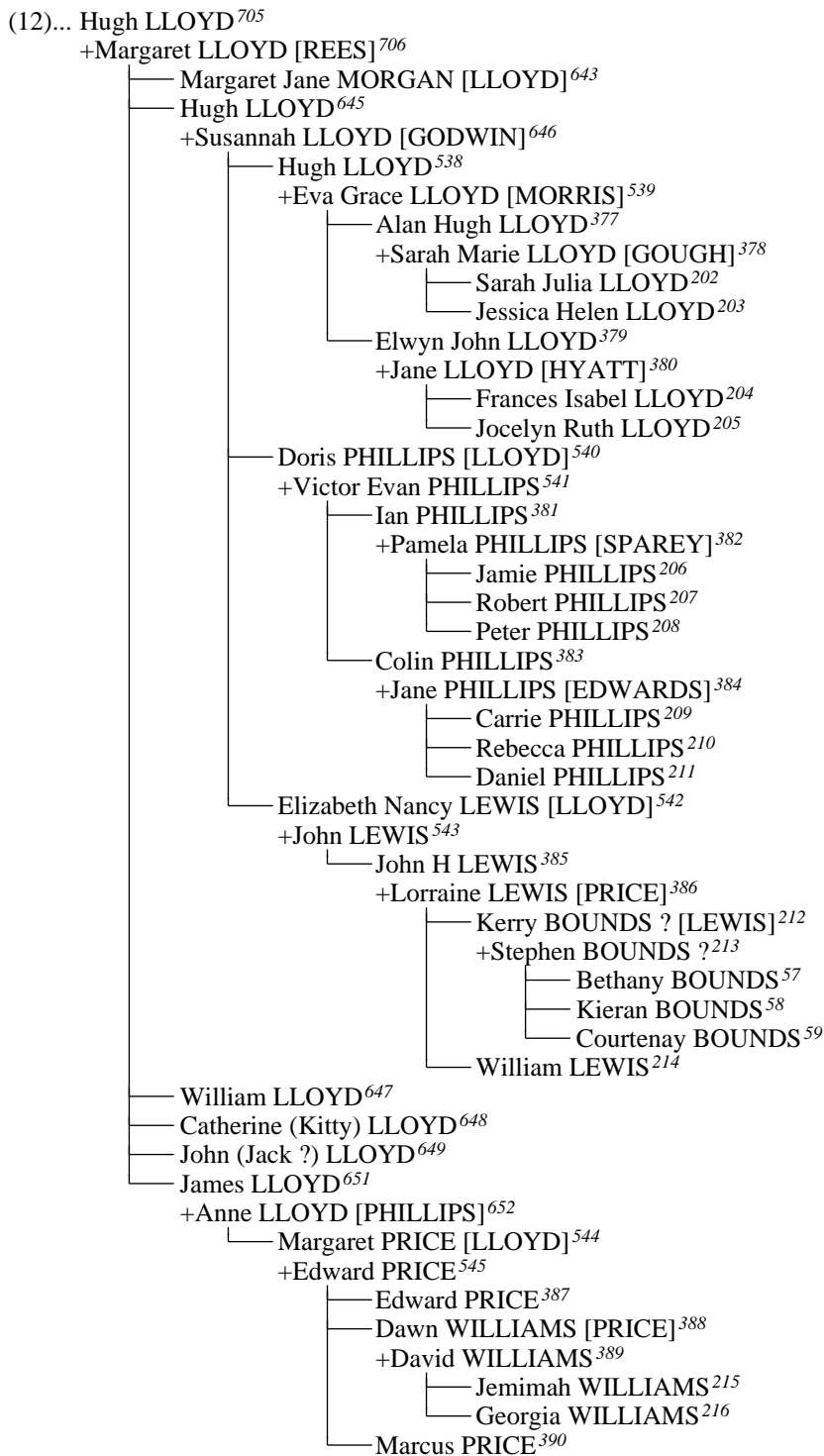

- (14)... Edward Lewis LLOYD⁷¹³
 +Catherine LLOYD [POWELL]⁷¹⁴
 └— Emily LLOYD⁶⁶⁰
- (15)... Evan LLOYD⁷¹⁷
 +Emma Eliza LLOYD [BOND]⁷¹⁸
 └— Lillian LLOYD⁶⁶¹
 └— William LLOYD⁶⁶²
 └— Herbert LLOYD⁶⁶³
- (16)... Elizabeth MEREDITH [LLOYD]⁷²³
 +David Thomas MEREDITH⁷²⁴
 └— Eleanor Edith MEREDITH⁶⁶⁴
 └— Hilda Elizabeth MEREDITH⁶⁶⁵
 └— Winifred Sarah MEREDITH⁶⁶⁶
- (17)... Sarah EVANS [LLOYD]⁷⁵²
 +James EVANS⁷⁵³
 └— James EVANS⁷²⁵
 └— John EVANS⁷²⁶
 └— Sarah Ann EVANS⁷²⁷
 └— John EVANS⁷²⁸
 └— Hugh Lloyd EVANS⁷²⁹
 └— Thomas EVANS⁷³⁰
 └— William EVANS⁷³¹
 └— Sarah Ann PARRY [EVANS]⁷³²
 └— Marianne EVANS⁷³⁴
- (18)... Richard David BYWATER²¹⁷
 +Joan S BYWATER [MARTIN]²¹⁸
 └— Richard Mathew BYWATER⁶⁰
 +Susan BYWATER [PRIEST]⁶¹
 └— Richard William BYWATER¹
 └— Thomas David BYWATER³
 └— Emma Jane BYWATER⁴
 └— James Edward BYWATER⁵
 └— Rebecca BYWATER⁶²
 └— Olivia STEPHENS [BYWATER]⁶³
 +Peter j STEPHENS⁶⁴
 └— Scott STEPHENS⁶
 └— Edward STEPHENS⁷
 └— Sebastian BYWATER⁶⁵
 +Caroline BYWATER [ANDERSON]⁶⁶
 └— Alice Victoria BYWATER⁸
 └— Benjamin David BYWATER⁹
 └— Louise Joan BYWATER¹⁰
- (19)... Margaret LEWIS [BYWATER]²²¹
 +Gordon G LEWIS²²²
 └— Stehphen K LEWIS⁶⁷
 └— Richard J LEWIS⁶⁸
- (20)... John BYWATER²²⁶
 +Louise BYWATER²²⁷
 └— James BYWATER⁶⁹
 └— Anna Louise BYWATER⁷⁰
- (21)... Ruth JAMES [BYWATER]²²⁸
 +Jeff JAMES²²⁹
 └— Jenny JAMES⁷¹
 └— Alan JAMES⁷²

- (22)... Robin BYWATER BVMS, PhD²³⁰
 +May BYWATER [SCOTT]²³¹
 └ Owen BYWATER⁷³
 └ Simon BYWATER⁷⁴
- (23)... Sally PRICE [BYWATER]²³²
 +Russell PRICE²³³
 └ James PRICE⁷⁵
- (24)... John BYWATER²³⁴
 +Kate BYWATER [JONES]²³⁵
 └ Richard BYWATER⁷⁶
 └ Rachel BYWATER⁷⁷
- (25)... Rosemary THOMAS [BYWATER]²³⁶
 +Roger THOMAS²³⁷
 └ Richard Roger THOMAS⁷⁸
- (26)... Richard MORRIS²³⁹
 +Vivien MORRIS [EVANS]²⁴⁰
 └ Julia MACLACHLAN [MORRIS]⁸⁰
 └ Tamsin YORK [MORRIS]⁸²
- (27)... Murray Lloyd BYWATER²⁴¹
 +Pamela BYWATER²⁴²
 └ Mr. Unknown⁸⁴
 └ Ms. Unknown⁸⁵
- (28)... Judith Lloyd CLIFFORD [BYWATER]²⁴³
 +Peter CLIFFORD²⁴⁴
 └ Thomas CLIFFORD⁸⁶
- (29)... Richard Lloyd BYWATER²⁴⁵
 +Linda BYWATER²⁴⁷
 └ Mr. Unknown⁸⁷
 └ Ms. Unknown⁸⁸
- (30)... John BYWATER²⁴⁸
 +Sue BYWATER [COXON]²⁴⁹
 └ David BYWATER⁸⁹
 └ Gillian BYWATER⁹⁰
- (31)... Joyce Sarah HARRIS [BYWATER]⁴¹³
 +Edward HARRIS⁴¹⁴
 └ Edward HARRIS²⁵³
 └ +Margaret HARRIS²⁵⁴
 └ Anne HARRIS⁹¹
 └ Louise HARRIS⁹²
 └ Janet HARRIS⁹³
 └ Edward HARRIS⁹⁴
 └ Thomas L HARRIS²⁵⁵
 └ +Kathleen M HARRIS [JONES]²⁵⁶
 └ Richard HARRIS⁹⁵
 └ Edward HARRIS⁹⁶
 └ Jane HARRIS⁹⁷
- (32)... Constance Minnie DAVIES [BYWATER]⁴¹⁵
 +Trevor Glyn DAVIES⁴¹⁶
 └ Charles DAVIES²⁵⁷
 └ +Ms. DAVIES²⁵⁹
 └ Ben DAVIES⁹⁸
 └ Bethan DAVIES⁹⁹
 └ Julie GRIFFITHS [DAVIES]²⁶⁰
 └ +Mr. GRIFFITHS²⁶¹
 └ Tim GRIFFITHS¹⁰⁰

(33)... William Thomas ROBERTS⁴¹⁷
 +Doris ROBERTS [MASON]⁴¹⁸
 └─ Maisie Annie ROBERTS²⁶²
 +Dr Tony WHATELEY²⁶³
 └─ Julie Anne WHATELEY¹⁰¹
 └─ Phillipa Anne WHATELEY¹⁰²
 └─ Elizabeth Mary (Betty) WEBB [ROBERTS]²⁶⁵
 +David WEBB²⁶⁶
 └─ Alan WEBB¹⁰³
 +Ms. WEBB¹⁰⁴
 └─ Mr. WEBB¹¹
 └─ Mr. WEBB¹²
 └─ Mr. WEBB¹³
 └─ Jane WEBB¹⁰⁵

(34)... James Albert ROBERTS⁴²⁰
 +Annie ROBERTS [WILLIAMS]⁴²¹
 └─ Joyce ROBERTS²⁶⁷
 └─ Doreen ROBERTS²⁶⁸
 └─ Newton ROBERTS²⁶⁹
 └─ Andrew William ROBERTS¹⁰⁶
 └─ James ROBERTS¹⁴

(35)... William Caleb ROBERTS⁴²²
 +Mona A ROBERTS [PLAIN]⁴²³
 └─ Caleb Thomas ROBERTS²⁷⁰
 └─ Andrew William ROBERTS¹⁰⁷
 └─ James ROBERTS¹⁵

(36)... Lowri Angharad EVANS [STEPHENS]¹¹⁸
 +Gareth EVANS¹¹⁹
 └─ Martha Glain EVANS²⁹
 └─ Begw Angaharad EVANS³⁰
 └─ Elis Rhys EVANS³¹

(37)... Heledd Melangell DAY [STEPHENS]¹²⁰
 +Geraint DAY¹²¹
 └─ Gwenno Angaharad DAY³²
 └─ Gethin Emrys DAY³³

(38)... Brengain Gwennlian EVANS [STEPHENS]¹²²
 +Aron EVANS¹²³
 └─ Elan Meredydd EVANS³⁴
 └─ Rhiannon Wynn EVANS³⁵
 └─ Gwern Arthur Rhys EVANS³⁶
 └─ Luned Rhys EVANS³⁷
 └─ Menna Llwyd EVANS³⁸

(39)... Sian CORRIE [STEPHENS]¹²⁵
 +Clive CORRIE¹²⁶
 └─ Imogen CORRIE³⁹
 └─ Isobel CORRIE⁴⁰

(40)... Neil STEPHENS¹²⁷
 +Alison STEPHENS¹²⁸
 └─ George STEPHENS⁴¹
 └─ Thomas STEPHENS⁴²

- (41)... Aubrey E Michael PRITCHETT²⁸⁵
 +Janet PRITCHETT [BEASLEY]²⁸⁶
 └─ Bruce PRITCHETT¹³⁰
 +Jane PRITCHETT¹³¹
 └─ David PRITCHETT⁴³
 └─ John PRITCHETT⁴⁴
 └─ Sarah Jane PRITCHETT⁴⁵
 └─ Jill BACE [PRITCHETT]¹³²
 +Gordon BACE¹³³
 └─ Katy BACE⁴⁶
 └─ Ivor BACE⁴⁷
- (42)... Philip LANE²⁸⁷
 +Susan LANE²⁸⁸
 └─ Timothy LANE¹³⁴
 └─ Camilla LANE¹³⁵
- (43)... David Philip John LLOYD CEng, CITP, MBCS., MAPM²⁹¹
 +Maria Alexandra LLOYD [BUBEAR] RGN RMN²⁹²
 └─ Emily Rebekah LLOYD¹³⁶
 └─ Jessica Alys Sykes [LLOYD]¹³⁷
 └─ Victoria Alexandra LLOYD¹³⁹
- (44)... Peter Geoffrey LLOYD²⁹³
 +Karen Margaret LLOYD [DAWE]²⁹⁴
 └─ John James LLOYD¹⁴⁰
 └─ Naomi Ruth LLOYD¹⁴¹
- (45)... Andrew Robert LLOYD RAF²⁹⁵
 +Cheryl Esther LLOYD [DUGGAN]²⁹⁶
 └─ Bethany Esther LLOYD¹⁴²
 └─ Josie LLOYD¹⁴³
- (46)... Kathryn Ann LEWIS [BOWS] BMedSci , BM, BS²⁹⁷
 +Robin LEWIS²⁹⁸
 └─ Benjamin Thomas LEWIS¹⁴⁴
 └─ Rhiannon Jayne LEWIS¹⁴⁵
 └─ Anneli Rachel LEWIS¹⁴⁶
- (47)... Richard BOWS RAF (Retd)²⁹⁹
 +Terri BOWS [EASTWOOD]³⁰⁰
 └─ Sarah Louise BOWS¹⁴⁷
 └─ Laura Anne BOWS¹⁴⁸
 └─ Monica Rose BOWS⁴⁸
 └─ Nicola Christina BOWS¹⁴⁹
- (48)... Stephen Gareth LLOYD BSc, D.C³⁰⁶
 +Juliet LLOYD [DENMAN] Grad Dip TH³⁰⁷
 └─ Eleanor Joy HOLLAND [LLOYD] LLB (Oxon), LLM¹⁵⁰
 └─ Kathryn Louise LLOYD BA, MA¹⁵²
- (49)... Peter Adrian LLOYD³⁰⁸
 +Catherine LLOYD [FOLEY]³⁰⁹
 └─ Samuel Peter LLOYD¹⁵³
 └─ Kezia Catherine Faith LLOYD¹⁵⁴
- (50)... Bronwen Dorothy STRATTON³¹³
 +David EARTHROWL³¹⁴
 └─ Tomos EARTHROWL¹⁵⁵
 └─ James Edward EARTHROWL¹⁵⁶

(51)... Janet LEWIS [ROBERTS-LEWIS]³¹⁸
 +Christopher Illtyd LEWIS³¹⁹
 └─ Megan Elizabeth ROBERTS-LEWIS¹⁵⁷
 └─ Timothy John ROBERTS-LEWIS¹⁵⁸
 └─ Cerian ROBERTS-LEWIS¹⁵⁹

(52)... Robert JONES³²²
 +Nicola JONES [EVANS]³²³
 └─ Jessica JONES¹⁶²
 └─ Sophia JONES¹⁶³
 └─ Harriet JONES¹⁶⁴

(53)... Ann BLANDFORD [JONES]³²⁴
 +Timothy BLANDFORD³²⁵
 └─ Toby BLANDFORD¹⁶⁵
 └─ Henry BLANDFORD¹⁶⁶
 └─ Jane BLANDFORD¹⁶⁷

(54)... Jane HARRISON [POWELL]³⁴⁴
 +Karl HARRISON³⁴⁵
 └─ Ben HARRISON¹⁶⁸
 └─ Tia HARRISON¹⁶⁹

(55)... Clare TUFT [POWELL]³⁴⁶
 +Stephen TUFT³⁴⁷
 └─ Eva TUFT¹⁷⁰
 └─ Sally TUFT¹⁷¹
 └─ Joel TUFT¹⁷²

(56)... Kenneth (Ken) WILLIAMS³⁵¹
 +Vera Lindsley WILLIAMS³⁵²
 └─ Paul WILLIAMS¹⁷³

(57)... Glyn WILLIAMS³⁵³
 +Dilys WILLIAMS [WATKINS]³⁵⁴
 └─ Leslie WILLIAMS¹⁷⁴
 └─ +Mr. Unknown¹⁷⁵
 └─ └─ Jamie Unknown⁴⁹
 └─ Michael WILLIAMS¹⁷⁶
 └─ +Ms. WILLIAMS¹⁷⁷
 └─ └─ Megan WILLIAMS⁵⁰
 └─ Lynette WILLIAMS¹⁷⁸
 └─ +Mr. Unknown¹⁷⁹
 └─ └─ Rhys Unknown⁵¹

(58)... Rita Hazel FARMER [JAMES]³⁵⁵
 +Herbert Oliver FARMER³⁵⁶
 └─ Theresa Louise AWAAD [FARMER]¹⁸⁰
 └─ +Mohammed Osman M AWAAD¹⁸¹
 └─ └─ Omar AWAAD⁵²
 └─ └─ Ayman AWAAD⁵³
 └─ Adrian Oliver FARMER¹⁸²
 └─ +Jane FARMER [TITLEY]¹⁸³
 └─ └─ Rebecca Catherine FARMER⁵⁴
 └─ └─ Mathew James FARMER⁵⁵

(59)... Winston Barrie MORGAN³⁶⁰
 +Nancy C MORGAN [TAYLOR]³⁶¹
 └─ Thomas MORGAN¹⁸⁴
 └─ Matthew MORGAN¹⁸⁵
 └─ Nicola MORGAN¹⁸⁶
 └─ Edward MORGAN¹⁸⁷

(60)... Elizabeth Anne NEWTON [LLOYD]³⁶⁶
+Roger John NEWTON³⁶⁷
├── Anthony Paul NEWTON¹⁸⁸
└── Amanda Louise NEWTON¹⁹⁰
 └── Lillie Belle Unknown⁵⁶

(61)... David Evan LLOYD³⁶⁸
+Irene LLOYD [DURRELL]³⁶⁹
├── Cassie LLOYD¹⁹¹
├── Sean LLOYD¹⁹²
├── Sophie LLOYD¹⁹³
└── Christopher LLOYD¹⁹⁴

(62)... Graham C LLOYD³⁷¹
+Wendy LLOYD [WILLIAMS]³⁷²
├── Jane LLOYD¹⁹⁵
├── Paul LLOYD¹⁹⁶
└── Gareth LLOYD¹⁹⁷

(63)... Anita Jane SKYRME [POWELL]³⁷³
+Richard Philip SKYRME³⁷⁴
├── Chloe Jane SKYRME¹⁹⁸
└── Richard David SKYRME¹⁹⁹

(64)... Kathryn Ann WILLIAMS [POWELL]³⁷⁵
+Christopher John WILLIAMS³⁷⁶
├── Eleanor Ann WILLIAMS²⁰⁰
└── Jack Rhys WILLIAMS²⁰¹

2. DIRECT RELATIONS

Generation of Six-Times-Great-Grandchildren

1. RICHARD WILLIAM BYWATER (John's six-times-great-granddaughter) was born to Richard Mathew BYWATER⁶⁰ and Susan BYWATER [PRIEST]⁶¹, as shown in family tree 1.
2. KIRSTEN UNKNOWN (John's six-times-great-granddaughter's husband).
Kirsten Unknown married Richard William BYWATER¹.
3. THOMAS DAVID BYWATER (John's six-times-great-grandson) was born to Richard Mathew BYWATER⁶⁰ and Susan BYWATER [PRIEST]⁶¹, as shown in family tree 1.
4. EMMA JANE BYWATER (John's six-times-great-granddaughter) was born to Richard Mathew BYWATER⁶⁰ and Susan BYWATER [PRIEST]⁶¹, as shown in family tree 1.
5. JAMES EDWARD BYWATER (John's six-times-great-grandson) was born to Richard Mathew BYWATER⁶⁰ and Susan BYWATER [PRIEST]⁶¹, as shown in family tree 1.
6. SCOTT STEPHENS (John's six-times-great-grandson) was born to Peter j STEPHENS⁶⁴ and Olivia STEPHENS [BYWATER]⁶³, as shown in family tree 2.
7. EDWARD STEPHENS (John's six-times-great-grandson) was born to Peter j STEPHENS⁶⁴ and Olivia STEPHENS [BYWATER]⁶³, as shown in family tree 2.
8. ALICE VICTORIA BYWATER (John's six-times-great-granddaughter) was born in 1994 to Sebastian BYWATER⁶⁵ and Caroline BYWATER [ANDERSON]⁶⁶, as shown in family tree 3.
9. BENJAMIN DAVID BYWATER (John's six-times-great-grandson) was born in 1998 to Sebastian BYWATER⁶⁵ and Caroline BYWATER [ANDERSON]⁶⁶, as shown in family tree 3.
10. LOUISE JOAN BYWATER (John's six-times-great-granddaughter) was born in 2002 to Sebastian BYWATER⁶⁵ and Caroline BYWATER [ANDERSON]⁶⁶, as shown in family tree 3.
11. MR. WEBB (John's six-times-great-grandson) was born to Alan WEBB¹⁰³ and Ms. WEBB¹⁰⁴, as shown in family tree 4.
12. MR. WEBB (John's six-times-great-grandson) was born to Alan WEBB¹⁰³ and Ms. WEBB¹⁰⁴, as shown in family tree 4.
13. MR. WEBB (John's six-times-great-grandson) was born to Alan WEBB¹⁰³ and Ms. WEBB¹⁰⁴, as shown in family tree 4.
14. JAMES ROBERTS (John's six-times-great-grandson) was born in 1969 to Andrew William ROBERTS¹⁰⁶, as shown in family tree 5.
15. JAMES ROBERTS (John's six-times-great-grandson) was born in 1969 to Andrew William ROBERTS¹⁰⁷, as shown in family tree 6.
16. OWEN BOWERS (John's six-times-great-grandson) was born in 1978 to Stewart BOWERS¹⁰⁹ and Jeanne BOWERS [BROWN]¹⁰⁸, as shown in family tree 7.
17. KATHERINE (KATE) BOWERS (John's six-times-great-granddaughter) was born in 1979 to Stewart BOWERS¹⁰⁹ and Jeanne BOWERS [BROWN]¹⁰⁸, as shown in family tree 7.
18. JAMES BOWERS (John's six-times-great-grandson) was born in 1981 to Stewart BOWERS¹⁰⁹ and Jeanne BOWERS [BROWN]¹⁰⁸, as shown in family tree 7.
19. BETHAN NERY'S UNKNOWN (John's six-times-great-granddaughter) was born to Carol BROWN¹¹⁰, as shown in family tree 8.
20. HUW LEWIS (John's six-times-great-grandson) was born in 1982 to Mr. LEWIS¹¹² and Alison LEWIS [BROWN]¹¹¹, as shown in family tree 9.
21. RHYS LEWIS (John's six-times-great-grandson) was born in 1984 to Mr. LEWIS¹¹² and Alison LEWIS [BROWN]¹¹¹, as shown in family tree 9.
22. ELINOR LEWIS (John's six-times-great-granddaughter) was born in 1988 to Mr. LEWIS¹¹² and Alison LEWIS [BROWN]¹¹¹, as shown in family tree 9.

23. KELLY BROWN (John's six-times-great-granddaughter) was born in 1987 to Wynn BROWN¹¹³ and Margaret BROWN [BAGLEY]¹¹⁴, as shown in family tree 10.
24. ANNA BROWN (John's six-times-great-granddaughter) was born in 1991 to Wynn BROWN¹¹³ and Margaret BROWN [BAGLEY]¹¹⁴, as shown in family tree 10.
25. MARK BROWN (John's six-times-great-grandson) was born in 1993 to Wynn BROWN¹¹³ and Margaret BROWN [BAGLEY]¹¹⁴, as shown in family tree 10.
26. ROBIN BROWN (John's six-times-great-grandson) was born in 1993 to Nigel BROWN¹¹⁵, as shown in family tree 11.
27. RHIANNON DORWOOD (John's six-times-great-granddaughter) was born in 1987 to Mr. DORWOOD¹¹⁷ and Claire DORWOOD [BROWN]¹¹⁶, as shown in family tree 12.
28. MEGAN DORWOOD (John's six-times-great-granddaughter) was born in 1989 to Mr. DORWOOD¹¹⁷ and Claire DORWOOD [BROWN]¹¹⁶, as shown in family tree 12.
29. MARTHA GLAIN EVANS (John's six-times-great-granddaughter) was born in 1999 to Gareth EVANS¹¹⁹ and Lowri Angharad EVANS [STEPHENS]¹¹⁸, as shown in family tree 13.
30. BEGW ANGAHARAD EVANS (John's six-times-great-granddaughter) was born in 2004 to Gareth EVANS¹¹⁹ and Lowri Angharad EVANS [STEPHENS]¹¹⁸, as shown in family tree 13.
31. ELIS RHYS EVANS (John's six-times-great-grandson) was born in 2004 to Gareth EVANS¹¹⁹ and Lowri Angharad EVANS [STEPHENS]¹¹⁸, as shown in family tree 13.
32. GWENNO ANGAHARAD DAY (John's six-times-great-granddaughter) was born in May 2002, in Pontypridd, to Geraint DAY¹²¹ and Heledd Melangell DAY [STEPHENS]¹²⁰, as shown in family tree 14.
33. GETHIN EMRYS DAY (John's six-times-great-grandson) was born in January 2005 to Geraint DAY¹²¹ and Heledd Melangell DAY [STEPHENS]¹²⁰, as shown in family tree 14.
34. ELAN MEREDYDD EVANS (John's six-times-great-granddaughter) was born in 1993 to Aron EVANS¹²³ and Brengain Gwenllian EVANS [STEPHENS]¹²², as shown in family tree 15.
35. RHIANNON WYNN EVANS (John's six-times-great-granddaughter) was born in 1996 to Aron EVANS¹²³ and Brengain Gwenllian EVANS [STEPHENS]¹²², as shown in family tree 15.
36. GWERN ARTHUR RHYS EVANS (John's six-times-great-grandson) was born in 1997 to Aron EVANS¹²³ and Brengain Gwenllian EVANS [STEPHENS]¹²², as shown in family tree 15.
37. LUNED RHYS EVANS (John's six-times-great-grandson) was born in 2004 to Aron EVANS¹²³ and Brengain Gwenllian EVANS [STEPHENS]¹²², as shown in family tree 15.
38. MENNA LLWYD EVANS (John's six-times-great-granddaughter) was born on 7 September 2008 to Aron EVANS¹²³ and Brengain Gwenllian EVANS [STEPHENS]¹²², as shown in family tree 15.
39. IMOGEN CORRIE (John's six-times-great-granddaughter) was born to Clive CORRIE¹²⁶ and Sian CORRIE [STEPHENS]¹²⁵, as shown in family tree 16.
40. ISOBEL CORRIE (John's six-times-great-granddaughter) was born to Clive CORRIE¹²⁶ and Sian CORRIE [STEPHENS]¹²⁵, as shown in family tree 16.
41. GEORGE STEPHENS (John's six-times-great-grandson) was born to Neil STEPHENS¹²⁷ and Alison STEPHENS¹²⁸, as shown in family tree 17.
42. THOMAS STEPHENS (John's six-times-great-grandson) was born to Neil STEPHENS¹²⁷ and Alison STEPHENS¹²⁸, as shown in family tree 17.
43. DAVID PRITCHETT (John's six-times-great-grandson) was born in 1990 to Bruce PRITCHETT¹³⁰ and Jane PRITCHETT¹³¹, as shown in family tree 18.
44. JOHN PRITCHETT (John's six-times-great-grandson) was born in September 1996 to Bruce PRITCHETT¹³⁰ and Jane PRITCHETT¹³¹, as shown in family tree 18.

45. SARAH JANE PRITCHETT (John's six-times-great-granddaughter) was born to Bruce PRITCHETT¹³⁰ and Jane PRITCHETT¹³¹, as shown in family tree 18.
46. KATY BACE (John's six-times-great-granddaughter) was born in 1990 to Gordon BACE¹³³ and Jill BACE [PRITCHETT]¹³², as shown in family tree 19.
47. IVOR BACE (John's six-times-great-grandson) was born in 1992 to Gordon BACE¹³³ and Jill BACE [PRITCHETT]¹³², as shown in family tree 19.
48. MONICA ROSE BOWS (John's six-times-great-granddaughter) was born on 6 February 2010 to Laura Anne BOWS¹⁴⁸, as shown in family tree 20.
49. JAMIE UNKNOWN (John's six-times-great-grandson) was born to Mr. Unknown¹⁷⁵ and Leslie WILLIAMS¹⁷⁴, as shown in family tree 21.
50. MEGAN WILLIAMS (John's six-times-great-granddaughter) was born in 2002 to Michael WILLIAMS¹⁷⁶ and Ms. WILLIAMS¹⁷⁷, as shown in family tree 22.
51. RHYS UNKNOWN (John's six-times-great-grandson) was born to Mr. Unknown¹⁷⁹ and Lynette WILLIAMS¹⁷⁸, as shown in family tree 23.
52. OMAR AWAAD (John's six-times-great-grandson) was born to Mohammed Osman M AWAAD¹⁸¹ and Theresa Louise AWAAD [FARMER]¹⁸⁰, as shown in family tree 24.
53. AYMAN AWAAD (John's six-times-great-grandson) was born to Mohammed Osman M AWAAD¹⁸¹ and Theresa Louise AWAAD [FARMER]¹⁸⁰, as shown in family tree 24.
54. REBECCA CATHERINE FARMER (John's six-times-great-granddaughter) was born in 1988, in Shrewsbury, UK, to Adrian Oliver FARMER¹⁸² and Jane FARMER [TITLEY]¹⁸³, as shown in family tree 25.
55. MATHEW JAMES FARMER (John's six-times-great-grandson) was born in 1991, in Shrewsbury, UK, to Adrian Oliver FARMER¹⁸² and Jane FARMER [TITLEY]¹⁸³, as shown in family tree 25.
56. LILLIE BELLE UNKNOWN (John's six-times-great-granddaughter) was born on 7 November 2001 to Amanda Louise NEWTON¹⁹⁰, as shown in family tree 26.
57. BETHANY BOUNDS (John's six-times-great-granddaughter) was born to Stephen BOUNDS^{?213} and Kerry BOUNDS ? [LEWIS]²¹², as shown in family tree 27.
58. KIERAN BOUNDS (John's six-times-great-grandson) was born to Stephen BOUNDS^{?213} and Kerry BOUNDS ? [LEWIS]²¹², as shown in family tree 27.
59. COURTENAY BOUNDS (John's six-times-great-granddaughter) was born to Stephen BOUNDS^{?213} and Kerry BOUNDS ? [LEWIS]²¹², as shown in family tree 27.

Generation of Five-Times-Great-Grandchildren

60. RICHARD MATHEW BYWATER (John's five-times-great-grandson) was born in 1961, in Ludlow, Shropshire, to Richard David BYWATER²¹⁷ and Joan S BYWATER [MARTIN]²¹⁸, as shown in family tree 28.
Notes:
- *Note 1.*
 - *Q4 (Birth).*
61. SUSAN BYWATER [PRIEST] (John's five-times-great-grandson's wife) was born in Topplesfield. See family tree 1.
Richard Mathew BYWATER⁶⁰ married Susan BYWATER [PRIEST]. They had four children:
- Richard William BYWATER¹
 - Thomas David BYWATER³
 - Emma Jane BYWATER⁴
 - James Edward BYWATER⁵
- This family is shown as family tree 1.*
62. REBECCA BYWATER (John's five-times-great-granddaughter) was born in 1963, in Ludlow, Shropshire, to Richard David BYWATER²¹⁷ and Joan S BYWATER [MARTIN]²¹⁸, as shown in family tree 28.
Note: *Q1 (Birth).*

63. OLIVIA STEPHENS [BYWATER] (John's five-times-great-granddaughter) was born in 1964 to Richard David BYWATER²¹⁷ and Joan S BYWATER [MARTIN]²¹⁸, as shown in family tree 28.
64. PETER J STEPHENS (John's five-times-great-granddaughter's husband). See family tree 2.
Peter j STEPHENS married Olivia STEPHENS [BYWATER]⁶³. They had two sons:
Scott STEPHENS⁶
Edward STEPHENS⁷
This family is shown as family tree 2.
65. SEBASTIAN BYWATER (John's five-times-great-grandson) was born in 1968, in Ludlow, Shropshire, to Richard David BYWATER²¹⁷ and Joan S BYWATER [MARTIN]²¹⁸, as shown in family tree 28. Sebastian became a Farmer.
Notes:
• *Note 2.*
• *Q2 (Birth).*
66. CAROLINE BYWATER [ANDERSON] (John's five-times-great-grandson's wife) was born in Bucknell. See family tree 3.
Sebastian BYWATER⁶⁵, aged about 26, married Caroline BYWATER [ANDERSON] in 1994. They had three children:
Alice Victoria BYWATER⁸ in 1994
Benjamin David BYWATER⁹ in 1998
Louise Joan BYWATER¹⁰ in 2002
This family is shown as family tree 3.
67. STEPHEN K LEWIS (John's five-times-great-grandson) was born in 1963, in Shrewsbury, UK, to Gordon G LEWIS²²² and Margaret LEWIS [BYWATER]²²¹, as shown in family tree 29.
Note: *Q4 (Birth).*
68. RICHARD J LEWIS (John's five-times-great-grandson) was born in 1965, in Shrewsbury, UK, to Gordon G LEWIS²²² and Margaret LEWIS [BYWATER]²²¹, as shown in family tree 29.
Note: *Q4 (Birth).*
69. JAMES BYWATER (John's five-times-great-grandson) was born to John BYWATER²²⁶ and Louise BYWATER²²⁷, as shown in family tree 30.
- 
70. ANNA LOUISE BYWATER (John's five-times-great-granddaughter) was born to John BYWATER²²⁶ and Louise BYWATER²²⁷, as shown in family tree 30.
71. JENNY JAMES (John's five-times-great-granddaughter) was born to Jeff JAMES²²⁹ and Ruth JAMES [BYWATER]²²⁸, as shown in family tree 31.
72. ALAN JAMES (John's five-times-great-grandson) was born to Jeff JAMES²²⁹ and Ruth JAMES [BYWATER]²²⁸, as shown in family tree 31. Alan died in 1965 in ? Road Accident.
73. OWEN BYWATER (John's five-times-great-grandson) was born on 23 August 1966 to Robin BYWATER BVMS, PhD²³⁰ and May BYWATER [SCOTT]²³¹, as shown in family tree 32.
74. SIMON BYWATER (John's five-times-great-grandson) was born on 3 June 1972 to Robin BYWATER BVMS, PhD²³⁰ and May BYWATER [SCOTT]²³¹, as shown in family tree 32.
75. JAMES PRICE (John's five-times-great-grandson) was born to Russell PRICE²³³ and Sally PRICE [BYWATER]²³², as shown in family tree 33.
76. RICHARD BYWATER (John's five-times-great-grandson) was born in 1971, in Clun, Shropshire, to John BYWATER²³⁴ and Kate BYWATER [JONES]²³⁵, as shown in family tree 34.
Note: *Q3 (Birth).*
77. RACHEL BYWATER (John's five-times-great-granddaughter) was born to John BYWATER²³⁴ and Kate BYWATER [JONES]²³⁵, as shown in family tree 34.
78. RICHARD ROGER THOMAS (John's five-times-great-grandson) was born to Roger THOMAS²³⁷ and Rosemary THOMAS [BYWATER]²³⁶, as shown in family tree 35.

79. GWENDOLINE THOMAS [RODERICK] (John's five-times-great-grandson's wife).
Richard Roger THOMAS⁷⁸ married Gwendoline THOMAS [RODERICK] in November 1998 in Brecknock, UK.
80. JULIA MACLACHLAN [MORRIS] (John's five-times-great-granddaughter) was born in 1969 to Richard MORRIS²³⁹ and Vivien MORRIS [EVANS]²⁴⁰, as shown in family tree 36.
81. RODERICK MACLACHLAN (John's five-times-great-granddaughter's husband).
Roderick MACLACHLAN married Julia MACLACHLAN [MORRIS]⁸⁰, aged about 21, in 1990.
82. TAMSIN YORK [MORRIS] (John's five-times-great-granddaughter) was born in 1974 to Richard MORRIS²³⁹ and Vivien MORRIS [EVANS]²⁴⁰, as shown in family tree 36.
83. CHRISTOPHER YORK (John's five-times-great-granddaughter's husband).
Christopher YORK married Tamsin YORK [MORRIS]⁸², aged about 27, in 2001.
84. MR. UNKNOWN (John's five-times-great-grandson) was born to Murray Lloyd BYWATER²⁴¹ and Pamela BYWATER²⁴², as shown in family tree 37.
85. MS. UNKNOWN (John's five-times-great-granddaughter) was born to Murray Lloyd BYWATER²⁴¹ and Pamela BYWATER²⁴², as shown in family tree 37.
86. THOMAS CLIFFORD (John's five-times-great-grandson) was born to Peter CLIFFORD²⁴⁴ and Judith Lloyd CLIFFORD [BYWATER]²⁴³, as shown in family tree 38.
87. MR. UNKNOWN (John's five-times-great-grandson) was born to Richard Lloyd BYWATER²⁴⁵ and Linda BYWATER²⁴⁷, as shown in family tree 39.
88. MS. UNKNOWN (John's five-times-great-granddaughter) was born to Richard Lloyd BYWATER²⁴⁵ and Linda BYWATER²⁴⁷, as shown in family tree 39.
89. DAVID BYWATER (John's five-times-great-grandson) was born to John BYWATER²⁴⁸ and Sue BYWATER [COXON]²⁴⁹, as shown in family tree 40.
90. GILLIAN BYWATER (John's five-times-great-granddaughter) was born to John BYWATER²⁴⁸ and Sue BYWATER [COXON]²⁴⁹, as shown in family tree 40.
91. ANNE HARRIS (John's five-times-great-granddaughter) was born to Edward HARRIS²⁵³ and Margaret HARRIS²⁵⁴, as shown in family tree 41.
92. LOUISE HARRIS (John's five-times-great-granddaughter) was born to Edward HARRIS²⁵³ and Margaret HARRIS²⁵⁴, as shown in family tree 41.
93. JANET HARRIS (John's five-times-great-granddaughter) was born to Edward HARRIS²⁵³ and Margaret HARRIS²⁵⁴, as shown in family tree 41.
94. EDWARD HARRIS (John's five-times-great-grandson) was born to Edward HARRIS²⁵³ and Margaret HARRIS²⁵⁴, as shown in family tree 41.
95. RICHARD HARRIS (John's five-times-great-grandson) was born to Thomas L HARRIS²⁵⁵ and Kathleen M HARRIS [JONES]²⁵⁶, as shown in family tree 42.
96. EDWARD HARRIS (John's five-times-great-grandson) was born to Thomas L HARRIS²⁵⁵ and Kathleen M HARRIS [JONES]²⁵⁶, as shown in family tree 42.
97. JANE HARRIS (John's five-times-great-granddaughter) was born to Thomas L HARRIS²⁵⁵ and Kathleen M HARRIS [JONES]²⁵⁶, as shown in family tree 42.
98. BEN DAVIES (John's five-times-great-grandson) was born to Charles DAVIES²⁵⁷ and Ms. DAVIES²⁵⁹, as shown in family tree 43.
99. BETHAN DAVIES (John's five-times-great-granddaughter) was born to Charles DAVIES²⁵⁷ and Ms. DAVIES²⁵⁹, as shown in family tree 43.
100. TIM GRIFFITHS (John's five-times-great-grandson) was born to Mr. GRIFFITHS²⁶¹ and Julie GRIFFITHS [DAVIES]²⁶⁰, as shown in family tree 44.
101. JULIE ANNE WHATELEY (John's five-times-great-granddaughter) was born in 1969 to Dr Tony WHATELEY²⁶³ and Maisie Annie ROBERTS²⁶², as shown in family tree 45.

102. PHILLIPA ANNE WHATELEY (John's five-times-great-granddaughter) was born in 1971, in Cambridge, UK, to Dr Tony WHATELEY²⁶³ and Maisie Annie ROBERTS²⁶², as shown in family tree 45.
103. ALAN WEBB (John's five-times-great-grandson) was born to David WEBB²⁶⁶ and Elizabeth Mary (Betty) WEBB [ROBERTS]²⁶⁵, as shown in family tree 46.
104. MS. WEBB (John's five-times-great-grandson's wife). See family tree 4.
 Alan WEBB¹⁰³ married Ms. WEBB. They had three sons:
 Mr. WEBB¹¹
 Mr. WEBB¹²
 Mr. WEBB¹³
This family is shown as family tree 4.
105. JANE WEBB (John's five-times-great-granddaughter) was born to David WEBB²⁶⁶ and Elizabeth Mary (Betty) WEBB [ROBERTS]²⁶⁵, as shown in family tree 46.
106. ANDREW WILLIAM ROBERTS (John's five-times-great-grandson) was born in 1946 to Newton ROBERTS²⁶⁹, as shown in family tree 47.
 Andrew fathered one son:
 James ROBERTS¹⁴ in 1969
This family is shown as family tree 5.
107. ANDREW WILLIAM ROBERTS (John's five-times-great-grandson) was born in 1946 to Caleb Thomas ROBERTS²⁷⁰, as shown in family tree 48.
 Andrew fathered one son:
 James ROBERTS¹⁵ in 1969
This family is shown as family tree 6.
108. JEANNE BOWERS [BROWN] (John's five-times-great-granddaughter) was born in 1956 to Derek BROWN²⁷² and Muriel Doreen LLOYD²⁷¹, as shown in family tree 49.
109. STEWART BOWERS (John's five-times-great-granddaughter's husband). See family tree 7.
 Stewart BOWERS married Jeanne BOWERS [BROWN]¹⁰⁸. They had three children:
 Owen BOWERS¹⁶ in 1978
 Katherine (Kate) BOWERS¹⁷ in 1979
 James BOWERS¹⁸ in 1981
This family is shown as family tree 7.
110. CAROL BROWN (John's five-times-great-granddaughter) was born in 1957 to Derek BROWN²⁷² and Muriel Doreen LLOYD²⁷¹, as shown in family tree 49.
 Carol gave birth to one daughter:
 Bethan Nerys Unknown¹⁹
This family is shown as family tree 8.
111. ALISON LEWIS [BROWN] (John's five-times-great-granddaughter) was born in 1959 to Derek BROWN²⁷² and Muriel Doreen LLOYD²⁷¹, as shown in family tree 49.
112. MR. LEWIS (John's five-times-great-granddaughter's husband). See family tree 9.
 Mr. LEWIS married Alison LEWIS [BROWN]¹¹¹. They had three children:
 Huw LEWIS²⁰ in 1982
 Rhys LEWIS²¹ in 1984
 Elinor LEWIS²² in 1988
This family is shown as family tree 9.
113. WYNN BROWN (John's five-times-great-grandson) was born in 1960 to Derek BROWN²⁷² and Muriel Doreen LLOYD²⁷¹, as shown in family tree 49.
114. MARGARET BROWN [BAGLEY] (John's five-times-great-grandson's wife). See family tree 10.
 Wynn BROWN¹¹³ married Margaret BROWN [BAGLEY]. They had three children:
 Kelly BROWN²³ in 1987
 Anna BROWN²⁴ in 1991
 Mark BROWN²⁵ in 1993
This family is shown as family tree 10.
115. NIGEL BROWN (John's five-times-great-grandson) was born in 1962 to Derek BROWN²⁷² and Muriel Doreen LLOYD²⁷¹, as shown in family tree 49.
 Nigel fathered one son:
 Robin BROWN²⁶ in 1993
This family is shown as family tree 11.

116. CLAIRE DORWOOD [BROWN] (John's five-times-great-granddaughter) was born in 1967 to Derek BROWN²⁷² and Muriel Doreen LLOYD²⁷¹, as shown in family tree 49.
117. MR. DORWOOD (John's five-times-great-granddaughter's husband). See family tree 12.
Mr. DORWOOD married Claire DORWOOD [BROWN]¹¹⁶. They had two daughters:
Rhiannon DORWOOD²⁷ in 1987
Megan DORWOOD²⁸ in 1989
This family is shown as family tree 12.
118. LOWRI ANGHARAD EVANS [STEPHENS] (John's five-times-great-granddaughter) was born in 1966 to Meic STEPHENS MA Dlott²⁸¹ and Ruth Wynn STEPHENS [MEREDITH]²⁸², as shown in family tree 50.
119. GARETH EVANS (John's five-times-great-granddaughter's husband). See family tree 13.
Gareth EVANS married Lowri Angharad EVANS [STEPHENS]¹¹⁸, aged about 25, in August 1991 in South Glamorgan. They had three children:
Martha Glain EVANS²⁹ in 1999
Begw Angaharad EVANS³⁰ in 2004
Elis Rhys EVANS³¹ in 2004
This family is shown as family tree 13.
120. HELEDD MELANGELL DAY [STEPHENS] (John's five-times-great-granddaughter) was born in 1968 to Meic STEPHENS MA Dlott²⁸¹ and Ruth Wynn STEPHENS [MEREDITH]²⁸², as shown in family tree 50.
121. GERAINT DAY (John's five-times-great-granddaughter's husband). See family tree 14.
Geraint DAY married Heledd Melangell DAY [STEPHENS]¹²⁰, aged about 33, in August 2001 in Cardiff. They had two children:
Gwenno Angaharad DAY³² in 2002
Gethin Emrys DAY³³ in 2005
This family is shown as family tree 14.
122. BRENGAIN GWENLLIAN EVANS [STEPHENS] (John's five-times-great-granddaughter) was born in 1969 to Meic STEPHENS MA Dlott²⁸¹ and Ruth Wynn STEPHENS [MEREDITH]²⁸², as shown in family tree 50.
123. ARON EVANS (John's five-times-great-granddaughter's husband). See family tree 15.
Aron EVANS married Brengain Gwenllian EVANS [STEPHENS]¹²², aged about 23, in September 1992 in South Glamorgan. They had five children:
Elan Meredydd EVANS³⁴ in 1993
Rhiannon Wynn EVANS³⁵ in 1996
Gwern Arthur Rhys EVANS³⁶ in 1997
Luned Rhys EVANS³⁷ in 2004
Menna Llwyd EVANS³⁸ in 2008
This family is shown as family tree 15.
124. HUW MEREDYDD STEPHENS (John's five-times-great-grandson) was born in May 1981, in Glamorganshire, to Meic STEPHENS MA Dlott²⁸¹ and Ruth Wynn STEPHENS [MEREDITH]²⁸², as shown in family tree 50.
125. SIAN CORRIE [STEPHENS] (John's five-times-great-granddaughter) was born in 1967 to Lloyd STEPHENS²⁸³ and Margaret Patricia Ismay STEPHENS [MORRIS]²⁸⁴, as shown in family tree 51.
126. CLIVE CORRIE (John's five-times-great-granddaughter's husband). See family tree 16.
Clive CORRIE married Sian CORRIE [STEPHENS]¹²⁵. They had two daughters:
Imogen CORRIE³⁹
Isobel CORRIE⁴⁰
This family is shown as family tree 16.
127. NEIL STEPHENS (John's five-times-great-grandson) was born to Lloyd STEPHENS²⁸³ and Margaret Patricia Ismay STEPHENS [MORRIS]²⁸⁴, as shown in family tree 51.
128. ALISON STEPHENS (John's five-times-great-grandson's wife). See family tree 17.
Neil STEPHENS¹²⁷ married Alison STEPHENS. They had two sons:
George STEPHENS⁴¹
Thomas STEPHENS⁴²
This family is shown as family tree 17.
129. CERI STEPHENS (John's five-times-great-granddaughter) was born in 1978 to Lloyd STEPHENS²⁸³ and Margaret Patricia Ismay STEPHENS [MORRIS]²⁸⁴, as shown in family tree 51.
130. BRUCE PRITCHETT (John's five-times-great-grandson) was born in 1957, in Cirencester, to Aubrey E Michael PRITCHETT²⁸⁵ and Janet PRITCHETT [BEASLEY]²⁸⁶, as shown in family tree 52.
131. JANE PRITCHETT (John's five-times-great-grandson's wife). See family tree 18.

Bruce PRITCHETT¹³⁰ married Jane PRITCHETT. They had three children:
 David PRITCHETT⁴³ in 1990
 John PRITCHETT⁴⁴ in 1996
 Sarah Jane PRITCHETT⁴⁵

This family is shown as family tree 18.

132. JILL BACE [PRITCHETT] (John's five-times-great-granddaughter) was born to Aubrey E Michael PRITCHETT²⁸⁵ and Janet PRITCHETT [BEASLEY]²⁸⁶, as shown in family tree 52.

133. GORDON BACE (John's five-times-great-granddaughter's husband). See family tree 19.

Gordon BACE married Jill BACE [PRITCHETT]¹³². They had two children:

Katy BACE⁴⁶ in 1990

Ivor BACE⁴⁷ in 1992

This family is shown as family tree 19.

134. TIMOTHY LANE (John's five-times-great-grandson) was born on 25 June 1982 to Philip LANE²⁸⁷ and Susan LANE²⁸⁸, as shown in family tree 53.

135. CAMILLA LANE (John's five-times-great-granddaughter) was born on 25 June 1982 to Philip LANE²⁸⁷ and Susan LANE²⁸⁸, as shown in family tree 53.

136. EMILY REBEKAH LLOYD (John's five-times-great-granddaughter) was born on 19 January 1986, in Southampton, to David Philip John LLOYD CEng, CIP, MBCS., MAPM²⁹¹ and Maria Alexandra LLOYD [BUBEAR] RGN RMN²⁹², as shown in family tree 54. Emily was educated (St Christophers Gibraltar; Selwood Frome, Newlands Sussex; Bicton College, Plymouth University).

The following information is also recorded for Emily. Religion: C of E.

Note: *Princess Anne Hospital (Birth)*.

137. JESSICA ALYS SYKES [LLOYD] (John's five-times-great-granddaughter) was born on 4 March 1987, in Fareham, Hampshire, to David Philip John LLOYD CEng, CIP, MBCS., MAPM²⁹¹ and Maria Alexandra LLOYD [BUBEAR] RGN RMN²⁹², as shown in family tree 54. She was christened in HMS SULTAN, Fareham, Hampshire. She was educated (St Christophers Gibraltar; Selwood Frome, Newlands Sussex, LVS Ascot). She became a Partner, White Hart Gastro pub, Rossendale.



Note: *Blackbrook Nursing Home (Birth)*.

138. MATHEW SYKES (John's five-times-great-granddaughter's husband).

Mathew Sykes married Jessica Alys Sykes [LLOYD]¹³⁷, aged 25, on 6 September 2012 in Bolton.

139. VICTORIA ALEXANDRA LLOYD (John's five-times-great-granddaughter) was born on 11 October 1989, in Fareham, Hampshire, to David Philip John LLOYD CEng, CIP, MBCS., MAPM²⁹¹ and Maria Alexandra LLOYD [BUBEAR] RGN RMN²⁹², as shown in family tree 54. She was christened in HMS COLLINGWOOD, Fareham, Hampshire. She was educated (St Christophers Gibraltar; Norton St Philip, Newland Sussex, LVS Ascot, Winchester University).



The following information is also recorded for Victoria. Religion: C of E.

Note: *Blackbrook NBursing Home (Birth)*.

140. JOHN JAMES LLOYD (John's five-times-great-grandson) was born on 1 June 1999, in Cheltenham, to Peter Geoffrey LLOYD²⁹³ and Karen Margaret LLOYD [DAWE]²⁹⁴, as shown in family tree 55.

141. NAOMI RUTH LLOYD (John's five-times-great-granddaughter) was born on 21 September 2003, in Melton Mowbray, to Peter Geoffrey LLOYD²⁹³ and Karen Margaret LLOYD [DAWE]²⁹⁴, as shown in family tree 55.

142. BETHANY ESTHER LLOYD (John's five-times-great-granddaughter) was born on 21 December 1999, in Witney, Oxford, to Andrew Robert LLOYD RAF²⁹⁵ and Cheryl Esther LLOYD [DUGGAN]²⁹⁶, as shown in family tree 56.

143. JOSIE LLOYD (John's five-times-great-granddaughter) was born on 20 September 2003 to Andrew Robert LLOYD RAF²⁹⁵ and Cheryl Esther LLOYD [DUGGAN]²⁹⁶, as shown in family tree 56.

144. BENJAMIN THOMAS LEWIS (John's five-times-great-grandson) was born in July 1987, in Poole, to Robin LEWIS²⁹⁸ and Kathryn Ann LEWIS [BOWS] BMedSci, BM, BS²⁹⁷, as shown in family tree 57.

145. RHIANNON JAYNE LEWIS (John's five-times-great-granddaughter) was born in November 1989, in Poole, to Robin LEWIS²⁹⁸ and Kathryn Ann LEWIS [BOWS] BMedSci, BM, BS²⁹⁷, as shown in family tree 57.

146. ANNELI RACHEL LEWIS (John's five-times-great-granddaughter) was born in August 1992, in Shrewsbury, UK, to Robin LEWIS²⁹⁸ and Kathryn Ann LEWIS [BOWS] BMedSci, BM, BS²⁹⁷, as shown in family tree 57.

147. SARAH LOUISE BOWS (John's five-times-great-granddaughter) was born in August 1986, in Mansfield, Nottinghamshire, to Richard BOWS RAF (Retd)²⁹⁹ and Terri BOWS [EASTWOOD]³⁰⁰, as shown in family tree 58.
148. LAURA ANNE BOWS (John's five-times-great-granddaughter) was born in February 1989, in Aylesbury Vale, to Richard BOWS RAF (Retd)²⁹⁹ and Terri BOWS [EASTWOOD]³⁰⁰, as shown in family tree 58.
 Laura gave birth to one daughter:
 Monica Rose BOWS⁴⁸ in 2010
This family is shown as family tree 20.
149. NICOLA CHRISTINA BOWS (John's five-times-great-granddaughter) was born in 1993 to Richard BOWS RAF (Retd)²⁹⁹ and Terri BOWS [EASTWOOD]³⁰⁰, as shown in family tree 58.
150. ELEANOR JOY HOLLAND [LLOYD] LLB (OXON), LLM (John's five-times-great-granddaughter) was born on 1 January 1985, in Cardiff, to Stephen Gareth LLOYD BSc, D.C.³⁰⁶ and Juliet LLOYD [DENMAN] Grad Dip TH³⁰⁷, as shown in family tree 59. Eleanor was educated (Howells School, Llandaff; Redcliffe Bible College; Jesus College, Oxford (2004 - 2008), Bristol University (2008-2009); BPP, London (2009 - 2010)). She became a Barrister specialising in Commercial Chancery.
151. BENJAMIN THOMAS TRISTRAM HOLLAND MENG (OXON) (John's five-times-great-granddaughter's husband) was born on 16 August 1985, in Cambridge, UK. Benjamin was educated (Chesterton Community College, Cambridge; Jesus College, Oxford (Scholar)). He became a Research Engineer.
 Benjamin Thomas Tristram HOLLAND MENG (Oxon) married Eleanor Joy HOLLAND [LLOYD] LLB (Oxon), LLM¹⁵⁰ in Oxford, UK.
 Note: *Chapel at Jesus College (Marriage).*
152. KATHRYN LOUISE LLOYD BA, MA (John's five-times-great-granddaughter) was born on 19 November 1986, in Cardiff, to Stephen Gareth LLOYD BSc, D.C.³⁰⁶ and Juliet LLOYD [DENMAN] Grad Dip TH³⁰⁷, as shown in family tree 59. Kathryn was educated (Howells's School, Llandaff; Nottingham University (2005 - 2009)). She became a Works for the Arts Councils; also writes and supports other artists.
153. SAMUEL PETER LLOYD (John's five-times-great-grandson) was born on 31 January 1986, in Oxford, UK, to Peter Adrian LLOYD³⁰⁸ and Catherine LLOYD [FOLEY]³⁰⁹, as shown in family tree 60. Samuel was educated (Kingham School, Leominster; Stoke St Gregory; Sandbach). He became a Christian Youth Worker, Nuneaton.
154. KEZIA CATHERINE FAITH LLOYD (John's five-times-great-granddaughter) was born on 21 December 1998, in Taunton, UK, to Peter Adrian LLOYD³⁰⁸ and Catherine LLOYD [FOLEY]³⁰⁹, as shown in family tree 60.
155. TOMOS EARTHROWL (John's five-times-great-grandson) was born on 26 February 1973 to David EARTHROWL³¹⁴ and Bronwen Dorothy STRATTON³¹³, as shown in family tree 61.
156. JAMES EDWARD EARTHROWL (John's five-times-great-grandson) was born on 7 April 1975 to David EARTHROWL³¹⁴ and Bronwen Dorothy STRATTON³¹³, as shown in family tree 61.
157. MEGAN ELIZABETH ROBERTS-LEWIS (John's five-times-great-granddaughter) was born on 11 May 1983 to Christopher Illtyd LEWIS³¹⁹ and Janet LEWIS [ROBERTS-LEWIS]³¹⁸, as shown in family tree 62.
158. TIMOTHY JOHN ROBERTS-LEWIS (John's five-times-great-grandson) was born on 22 March 1985 to Christopher Illtyd LEWIS³¹⁹ and Janet LEWIS [ROBERTS-LEWIS]³¹⁸, as shown in family tree 62.
159. CERIAN ROBERTS-LEWIS (John's five-times-great-grandson) was born on 17 October 1989 to Christopher Illtyd LEWIS³¹⁹ and Janet LEWIS [ROBERTS-LEWIS]³¹⁸, as shown in family tree 62.
160. CHARLOTTE JONES (John's five-times-great-granddaughter) was born to John JONES³²⁰ and Sandra JONES [MORGAN]³²¹, as shown in family tree 63.
161. REBECCA JONES (John's five-times-great-granddaughter) was born to John JONES³²⁰ and Sandra JONES [MORGAN]³²¹, as shown in family tree 63.
162. JESSICA JONES (John's five-times-great-granddaughter) was born to Robert JONES³²² and Nicola JONES [EVANS]³²³, as shown in family tree 64.
163. SOPHIA JONES (John's five-times-great-granddaughter) was born to Robert JONES³²² and Nicola JONES [EVANS]³²³, as shown in family tree 64.
164. HARRIET JONES (John's five-times-great-granddaughter) was born to Robert JONES³²² and Nicola JONES [EVANS]³²³, as shown in family tree 64.

165. TOBY BLANDFORD (John's five-times-great-grandson) was born to Timothy BLANDFORD³²⁵ and Ann BLANDFORD [JONES]³²⁴, as shown in family tree 65.
166. HENRY BLANDFORD (John's five-times-great-grandson) was born to Timothy BLANDFORD³²⁵ and Ann BLANDFORD [JONES]³²⁴, as shown in family tree 65.
167. JANE BLANDFORD (John's five-times-great-granddaughter) was born to Timothy BLANDFORD³²⁵ and Ann BLANDFORD [JONES]³²⁴, as shown in family tree 65.
168. BEN HARRISON (John's five-times-great-grandson) was born to Karl HARRISON³⁴⁵ and Jane HARRISON [POWELL]³⁴⁴, as shown in family tree 66.
169. TIA HARRISON (John's five-times-great-granddaughter) was born to Karl HARRISON³⁴⁵ and Jane HARRISON [POWELL]³⁴⁴, as shown in family tree 66.
170. EVA TUFT (John's five-times-great-granddaughter) was born to Stephen TUFT³⁴⁷ and Clare TUFT [POWELL]³⁴⁶, as shown in family tree 67.
171. SALLY TUFT (John's five-times-great-granddaughter) was born to Stephen TUFT³⁴⁷ and Clare TUFT [POWELL]³⁴⁶, as shown in family tree 67.
172. JOEL TUFT (John's five-times-great-grandson) was born to Stephen TUFT³⁴⁷ and Clare TUFT [POWELL]³⁴⁶, as shown in family tree 67.
173. PAUL WILLIAMS (John's five-times-great-grandson) was born in 1975 to Kenneth (Ken) WILLIAMS³⁵¹ and Vera Lindsley WILLIAMS³⁵², as shown in family tree 68.
174. LESLIE WILLIAMS (John's five-times-great-granddaughter) was born in 1969 to Glyn WILLIAMS³⁵³ and Dilys WILLIAMS [WATKINS]³⁵⁴, as shown in family tree 69.
175. MR. UNKNOWN (John's five-times-great-granddaughter's husband). See family tree 21.
Mr. Unknown married Leslie WILLIAMS¹⁷⁴. They had one son:
 Jamie Unknown⁴⁹
This family is shown as family tree 21.
176. MICHAEL WILLIAMS (John's five-times-great-grandson) was born in 1971 to Glyn WILLIAMS³⁵³ and Dilys WILLIAMS [WATKINS]³⁵⁴, as shown in family tree 69.
177. MS. WILLIAMS (John's five-times-great-grandson's wife). See family tree 22.
Michael WILLIAMS¹⁷⁶ married Ms. WILLIAMS. They had one daughter:
 Megan WILLIAMS⁵⁰ in 2002
This family is shown as family tree 22.
178. LYNETTE WILLIAMS (John's five-times-great-granddaughter) was born in 1973 to Glyn WILLIAMS³⁵³ and Dilys WILLIAMS [WATKINS]³⁵⁴, as shown in family tree 69.
179. MR. UNKNOWN (John's five-times-great-granddaughter's husband). See family tree 23.
Mr. Unknown married Lynette WILLIAMS¹⁷⁸. They had one son:
 Rhys Unknown⁵¹
This family is shown as family tree 23.
180. THERESA LOUISE AWAAD [FARMER] (John's five-times-great-granddaughter) was born in 1957, in Shrewsbury, UK, to Herbert Oliver FARMER³⁵⁶ and Rita Hazel FARMER [JAMES]³⁵⁵, as shown in family tree 70.
181. MOHAMMED OSMAN M AWAAD (John's five-times-great-granddaughter's husband). See family tree 24.
Mohammed Osman M AWAAD married Theresa Louise AWAAD [FARMER]¹⁸⁰. They had two sons:
 Omar AWAAD⁵²
 Ayman AWAAD⁵³
This family is shown as family tree 24.
182. ADRIAN OLIVER FARMER (John's five-times-great-grandson) was born in 1962, in Shrewsbury, UK, to Herbert Oliver FARMER³⁵⁶ and Rita Hazel FARMER [JAMES]³⁵⁵, as shown in family tree 70.





183. JANE FARMER [TITLEY] (John's five-times-great-grandson's wife) was born in 1965, in Shrewsbury, UK. See family tree 25.
 Adrian Oliver FARMER¹⁸² married Jane FARMER [TITLEY]. They had two children:
 Rebecca Catherine FARMER⁵⁴ in 1988
 Mathew James FARMER⁵⁵ in 1991
This family is shown as family tree 25.
184. THOMAS MORGAN (John's five-times-great-grandson) was born on 24 March 1988 to Winston Barrie MORGAN³⁶⁰ and Nancy C MORGAN [TAYLOR]³⁶¹, as shown in family tree 71.
185. MATTHEW MORGAN (John's five-times-great-grandson) was born on 22 May 1989 to Winston Barrie MORGAN³⁶⁰ and Nancy C MORGAN [TAYLOR]³⁶¹, as shown in family tree 71.
186. NICOLA MORGAN (John's five-times-great-granddaughter) was born on 31 May 1993 to Winston Barrie MORGAN³⁶⁰ and Nancy C MORGAN [TAYLOR]³⁶¹, as shown in family tree 71.
187. EDWARD MORGAN (John's five-times-great-grandson) was born on 31 May 1996 to Winston Barrie MORGAN³⁶⁰ and Nancy C MORGAN [TAYLOR]³⁶¹, as shown in family tree 71.
188. ANTHONY PAUL NEWTON (John's five-times-great-grandson) was born on 27 June 1970 to Roger John NEWTON³⁶⁷ and Elizabeth Anne NEWTON [LLOYD]³⁶⁶, as shown in family tree 72.
189. KELLY NEWTON [DAVIS] (John's five-times-great-grandson's wife) was born on 25 October 1977.
 Anthony Paul NEWTON¹⁸⁸ married Kelly NEWTON [DAVIS].
190. AMANDA LOUISE NEWTON (John's five-times-great-granddaughter) was born on 2 January 1975 to Roger John NEWTON³⁶⁷ and Elizabeth Anne NEWTON [LLOYD]³⁶⁶, as shown in family tree 72.
 Amanda gave birth to one daughter:
 Lillie Belle Unknown⁵⁶ in 2001
This family is shown as family tree 26.
191. CASSIE LLOYD (John's five-times-great-granddaughter) was born to David Evan LLOYD³⁶⁸ and Irene LLOYD [DURRELL]³⁶⁹, as shown in family tree 73.
192. SEAN LLOYD (John's five-times-great-grandson) was born to David Evan LLOYD³⁶⁸ and Irene LLOYD [DURRELL]³⁶⁹, as shown in family tree 73.
193. SOPHIE LLOYD (John's five-times-great-granddaughter) was born to David Evan LLOYD³⁶⁸ and Irene LLOYD [DURRELL]³⁶⁹, as shown in family tree 73.
194. CHRISTOPHER LLOYD (John's five-times-great-grandson) was born to David Evan LLOYD³⁶⁸ and Irene LLOYD [DURRELL]³⁶⁹, as shown in family tree 73.
195. JANE LLOYD (John's five-times-great-granddaughter) was born to Graham C LLOYD³⁷¹ and Wendy LLOYD [WILLIAMS]³⁷², as shown in family tree 74.
196. PAUL LLOYD (John's five-times-great-grandson) was born to Graham C LLOYD³⁷¹ and Wendy LLOYD [WILLIAMS]³⁷², as shown in family tree 74.
197. GARETH LLOYD (John's five-times-great-grandson) was born to Graham C LLOYD³⁷¹ and Wendy LLOYD [WILLIAMS]³⁷², as shown in family tree 74.
198. CHLOE JANE SKYRME (John's five-times-great-granddaughter) was born on 22 August 1994 to Richard Philip SKYRME³⁷⁴ and Anita Jane SKYRME [POWELL]³⁷³, as shown in family tree 75.
199. RICHARD DAVID SKYRME (John's five-times-great-grandson) was born on 5 December 1997 to Richard Philip SKYRME³⁷⁴ and Anita Jane SKYRME [POWELL]³⁷³, as shown in family tree 75.
200. ELEANOR ANN WILLIAMS (John's five-times-great-granddaughter) was born on 30 January 1998 to Christopher John WILLIAMS³⁷⁶ and Kathryn Ann WILLIAMS [POWELL]³⁷⁵, as shown in family tree 76.
201. JACK RHYS WILLIAMS (John's five-times-great-grandson) was born on 1 November 1999 to Christopher John WILLIAMS³⁷⁶ and Kathryn Ann WILLIAMS [POWELL]³⁷⁵, as shown in family tree 76.
202. SARAH JULIA LLOYD (John's five-times-great-granddaughter) was born on 26 June 1978 to Alan Hugh LLOYD³⁷⁷ and Sarah Marie LLOYD [GOUGH]³⁷⁸, as shown in family tree 77.

203. JESSICA HELEN LLOYD (John's five-times-great-granddaughter) was born on 14 May 1989 to Alan Hugh LLOYD³⁷⁷ and Sarah Marie LLOYD [GOUGH]³⁷⁸, as shown in family tree 77.
204. FRANCES ISABEL LLOYD (John's five-times-great-granddaughter) was born on 10 October 1979 to Elwyn John LLOYD³⁷⁹ and Jane LLOYD [HYATT]³⁸⁰, as shown in family tree 78.
205. JOCELYN RUTH LLOYD (John's five-times-great-granddaughter) was born on 7 November 1982 to Elwyn John LLOYD³⁷⁹ and Jane LLOYD [HYATT]³⁸⁰, as shown in family tree 78.
206. JAMIE PHILLIPS (John's five-times-great-grandson) was born in 1977 to Ian PHILLIPS³⁸¹ and Pamela PHILLIPS [SPAREY]³⁸², as shown in family tree 79.
207. ROBERT PHILLIPS (John's five-times-great-grandson) was born in 1980 to Ian PHILLIPS³⁸¹ and Pamela PHILLIPS [SPAREY]³⁸², as shown in family tree 79.
208. PETER PHILLIPS (John's five-times-great-grandson) was born in 1983 to Ian PHILLIPS³⁸¹ and Pamela PHILLIPS [SPAREY]³⁸², as shown in family tree 79.
209. CARRIE PHILLIPS (John's five-times-great-granddaughter) was born to Colin PHILLIPS³⁸³ and Jane PHILLIPS [EDWARDS]³⁸⁴, as shown in family tree 80.
210. REBECCA PHILLIPS (John's five-times-great-granddaughter) was born in 1986 to Colin PHILLIPS³⁸³ and Jane PHILLIPS [EDWARDS]³⁸⁴, as shown in family tree 80.
211. DANIEL PHILLIPS (John's five-times-great-grandson) was born in 1988 to Colin PHILLIPS³⁸³ and Jane PHILLIPS [EDWARDS]³⁸⁴, as shown in family tree 80.
212. KERRY BOUNDS ? [LEWIS] (John's five-times-great-granddaughter) was born to John H LEWIS³⁸⁵ and Lorraine LEWIS [PRICE]³⁸⁶, as shown in family tree 81.
213. STEPHEN BOUNDS ? (John's five-times-great-granddaughter's husband). See family tree 27.
 Stephen BOUNDS ? married Kerry BOUNDS ? [LEWIS]²¹². They had three children:
 Bethany BOUNDS⁵⁷
 Kieran BOUNDS⁵⁸
 Courtenay BOUNDS⁵⁹
This family is shown as family tree 27.
214. WILLIAM LEWIS (John's five-times-great-grandson) was born to John H LEWIS³⁸⁵ and Lorraine LEWIS [PRICE]³⁸⁶, as shown in family tree 81.
215. JEMIMAH WILLIAMS (John's five-times-great-granddaughter) was born to David WILLIAMS³⁸⁹ and Dawn WILLIAMS [PRICE]³⁸⁸, as shown in family tree 82.
216. GEORGIA WILLIAMS (John's five-times-great-granddaughter) was born to David WILLIAMS³⁸⁹ and Dawn WILLIAMS [PRICE]³⁸⁸, as shown in family tree 82.

Generation of Four-Times-Great-Grandchildren

217. RICHARD DAVID BYWATER (John's four-times-great-grandson) was born in 1935, in Ludlow, Shropshire, to Richard BYWATER³⁹⁸ and Mary Elizabeth BYWATER [THOMAS]³⁹⁹, as shown in family tree 83.
 Note: *Q3 (Birth)*.
218. JOAN S BYWATER [MARTIN] (John's four-times-great-grandson's wife) was born on 15 February 1935. See family tree 28.
 Richard David BYWATER²¹⁷, aged about 26, married Joan S BYWATER [MARTIN], aged about 26, in 1961 in Ludlow, Shropshire. They had four children:
 Richard Mathew BYWATER⁶⁰ in 1961
 Rebecca BYWATER⁶² in 1963
 Olivia STEPHENS [BYWATER]⁶³ in 1964
 Sebastian BYWATER⁶⁵ in 1968
This family is shown as family tree 28.
 Note: *Q1 (Marriage)*.
219. DARINDA M FISHER [BYWATER] (John's four-times-great-granddaughter) was born in 1936, in Ludlow, Shropshire, to Richard BYWATER³⁹⁸ and Mary Elizabeth BYWATER [THOMAS]³⁹⁹, as shown in family tree 83.

- Note: *Q4 (Birth)*.
220. BRIAN A S FISHER (John's four-times-great-granddaughter's husband) was born in 1931, in Ross, Herefordshire.
 Note: *Q4 (Birth)*.
 Brian A S FISHER, aged about 26, married Darinda M FISHER [BYWATER]²¹⁹, aged about 21, in 1957 in Ludlow, Shropshire.
 Note: *Q3 (Marriage)*.
221. MARGARET LEWIS [BYWATER] (John's four-times-great-granddaughter) was born in 1938, in Ludlow, Shropshire, to Richard BYWATER³⁹⁸ and Mary Elizabeth BYWATER [THOMAS]³⁹⁹, as shown in family tree 83.
 Note: *Q4 (Birth)*.
222. GORDON G LEWIS (John's four-times-great-granddaughter's husband). See family tree 29.
 Gordon G LEWIS married Margaret LEWIS [BYWATER]²²¹, aged about 22, in 1960 in Ludlow, Shropshire. They had two sons:
 Stephen K LEWIS⁶⁷ in 1963
 Richard J LEWIS⁶⁸ in 1965
This family is shown as family tree 29.
 Note: *Q2 (Marriage)*.
223. PHYLLIS ANNE BYWATER (John's four-times-great-granddaughter) was born in 1945, in Ludlow, Shropshire, to Richard BYWATER³⁹⁸ and Phyllis BYWATER [ELLIS]⁴⁰⁰, as shown in family tree 84.
 Note: *Q1 (Birth)*.
224. JOHN THOMAS BYWATER (John's four-times-great-grandson) was born in 1946, in Ludlow, Shropshire, to Richard BYWATER³⁹⁸ and Phyllis BYWATER [ELLIS]⁴⁰⁰, as shown in family tree 84. John died in 1970, aged about 24, in Car Accident.
 Note: *Q4 (Birth)*.
225. DAPHNE BYWATER (John's four-times-great-granddaughter) was born in 1948, in Ludlow, Shropshire, to Richard BYWATER³⁹⁸ and Phyllis BYWATER [ELLIS]⁴⁰⁰, as shown in family tree 84.
 Note: *Q3 (Birth)*.
226. DR JOHN BYWATER (John's four-times-great-grandson) was born to Caleb James BYWATER⁴⁰² and Doris BYWATER [WATKINS]⁴⁰³, as shown in family tree 85. John was a Medical Director. John died in 2004.
227. LOUISE BYWATER (John's four-times-great-grandson's wife). See family tree 30.
 John BYWATER²²⁶ married Louise BYWATER. They had two children:
 James BYWATER⁶⁹
 Anna Louise BYWATER⁷⁰
This family is shown as family tree 30.
228. RUTH JAMES [BYWATER] (John's four-times-great-granddaughter) was born in 1936 to Caleb James BYWATER⁴⁰² and Doris BYWATER [WATKINS]⁴⁰³, as shown in family tree 85. Ruth was a Bonesetter. Ruth died in 2006, aged about 70.
- 
229. JEFF JAMES (John's four-times-great-granddaughter's husband). See family tree 31.
 Jeff JAMES married Ruth JAMES [BYWATER]²²⁸. They had two children:
 Jenny JAMES⁷¹
 Alan JAMES⁷²
This family is shown as family tree 31.
230. DR ROBIN BYWATER BVMS, PHD (John's four-times-great-grandson) was born on 16 June 1941 to Caleb James BYWATER⁴⁰² and Doris BYWATER [WATKINS]⁴⁰³, as shown in family tree 85. Robin became a Veterinary Pharmacologist.
- 
231. MAY BYWATER [SCOTT] (John's four-times-great-grandson's wife). See family tree 32.
 Robin BYWATER BVMS, PhD²³⁰ married May BYWATER [SCOTT]. They had two sons:
 Owen BYWATER⁷³ in 1966
 Simon BYWATER⁷⁴ in 1972
This family is shown as family tree 32.

232. SALLY PRICE [BYWATER] (John's four-times-great-granddaughter) was born to Caleb James BYWATER⁴⁰² and Doris BYWATER [WATKINS]⁴⁰³, as shown in family tree 85.
233. RUSSELL PRICE (John's four-times-great-granddaughter's husband). See family tree 33.
Russell PRICE married Sally PRICE [BYWATER]²³² about 1968. They had one son:
James PRICE⁷⁵
This family is shown as family tree 33.
234. JOHN BYWATER (John's four-times-great-grandson) was born in 1943 to John (aka Jack) BYWATER⁴⁰⁵ and Edith BYWATER [DAVIES]⁴⁰⁶, as shown in family tree 86.
235. KATE BYWATER [JONES] (John's four-times-great-grandson's wife). See family tree 34.
John BYWATER²³⁴, aged about 26, married Kate BYWATER [JONES] in 1969. They had two children:
Richard BYWATER⁷⁶ in 1971
Rachel BYWATER⁷⁷
This family is shown as family tree 34.
236. ROSEMARY THOMAS [BYWATER] (John's four-times-great-granddaughter) was born in 1946 to John (aka Jack) BYWATER⁴⁰⁵ and Edith BYWATER [DAVIES]⁴⁰⁶, as shown in family tree 86.
237. ROGER THOMAS (John's four-times-great-granddaughter's husband). See family tree 35.
Roger THOMAS married Rosemary THOMAS [BYWATER]²³⁶, aged about 28, in 1974. They had one son:
Richard Roger THOMAS⁷⁸
This family is shown as family tree 35.
238. RICHARD BYWATER (John's four-times-great-grandson) was born in 1949 to John (aka Jack) BYWATER⁴⁰⁵ and Edith BYWATER [DAVIES]⁴⁰⁶, as shown in family tree 86.
239. DR RICHARD MORRIS (John's four-times-great-grandson) was born in 1944 to Ira MORRIS RAF⁴⁰⁸ and Naomi MORRIS [BYWATER]⁴⁰⁷, as shown in family tree 87.
240. DR VIVIEN MORRIS [EVANS] (John's four-times-great-grandson's wife) was born in 1942. See family tree 36.
Richard MORRIS²³⁹, aged about 22, married Vivien MORRIS [EVANS], aged about 24, in 1966. They had two daughters:
Julia MACLACHLAN [MORRIS]⁸⁰ in 1969
Tamsin YORK [MORRIS]⁸² in 1974
This family is shown as family tree 36.
241. MURRAY LLOYD BYWATER (John's four-times-great-grandson) was born about 1940 to Thomas BYWATER⁴⁰⁹ and Ishobel BYWATER [McLELLAN MILLAR]⁴¹⁰, as shown in family tree 88.
242. PAMELA BYWATER (John's four-times-great-grandson's wife). See family tree 37.
Murray Lloyd BYWATER²⁴¹, aged about 20, married Pamela BYWATER about 1960. They had two children:
Mr. Unknown⁸⁴
Ms. Unknown⁸⁵
This family is shown as family tree 37.
243. JUDITH LLOYD CLIFFORD [BYWATER] (John's four-times-great-granddaughter) was born to Thomas BYWATER⁴⁰⁹ and Ishobel BYWATER [McLELLAN MILLAR]⁴¹⁰, as shown in family tree 88.
244. PETER CLIFFORD (John's four-times-great-granddaughter's husband). See family tree 38.
Peter CLIFFORD married Judith Lloyd CLIFFORD [BYWATER]²⁴³ about 1968. They had one son:
Thomas CLIFFORD⁸⁶
This family is shown as family tree 38.
245. RICHARD LLOYD BYWATER (John's four-times-great-grandson) was born in 1943 to Thomas BYWATER⁴⁰⁹ and Ishobel BYWATER [McLELLAN MILLAR]⁴¹⁰, as shown in family tree 88.
Richard married twice. He was married to Ms. BYWATER²⁴⁶ and Linda BYWATER²⁴⁷.
246. MS. BYWATER (John's four-times-great-grandson's wife). Ms. BYWATER is no longer living.
Richard Lloyd BYWATER²⁴⁵ married Ms. BYWATER.
247. LINDA BYWATER (John's four-times-great-grandson's wife). See family tree 39.
Richard Lloyd BYWATER²⁴⁵ married Linda BYWATER. They had two children:
Mr. Unknown⁸⁷
Ms. Unknown⁸⁸
This family is shown as family tree 39.
248. JOHN BYWATER (John's four-times-great-grandson) was born in 1943 to Robert David BYWATER⁴¹¹ and Mary BYWATER [NOTT]⁴¹², as shown in family tree 89.
249. SUE BYWATER [COXON] (John's four-times-great-grandson's wife). See family tree 40.
John BYWATER²⁴⁸, aged about 23, married Sue BYWATER [COXON] in 1966. They had two children:
David BYWATER⁸⁹
Gillian BYWATER⁹⁰
This family is shown as family tree 40.

250. GEOFFREY BYWATER (John's four-times-great-grandson) was born in 1946 to Robert David BYWATER⁴¹¹ and Mary BYWATER [NOTT]⁴¹², as shown in family tree 89.
251. ROGER BYWATER (John's four-times-great-grandson) was born in 1947 to Robert David BYWATER⁴¹¹ and Mary BYWATER [NOTT]⁴¹², as shown in family tree 89.
252. MS. BYWATER (John's four-times-great-grandson's wife).
Roger BYWATER²⁵¹, aged about 45, married Ms. BYWATER about 1992.
253. EDWARD HARRIS (John's four-times-great-grandson) was born to Edward HARRIS⁴¹⁴ and Joyce Sarah HARRIS [BYWATER]⁴¹³, as shown in family tree 90.
254. MARGARET HARRIS (John's four-times-great-grandson's wife). See family tree 41.
Edward HARRIS²⁵³ married Margaret HARRIS in 1968. They had four children:
Anne HARRIS⁹¹
Louise HARRIS⁹²
Janet HARRIS⁹³
Edward HARRIS⁹⁴
This family is shown as family tree 41.
255. THOMAS L HARRIS (John's four-times-great-grandson) was born in 1944 to Edward HARRIS⁴¹⁴ and Joyce Sarah HARRIS [BYWATER]⁴¹³, as shown in family tree 90.
256. KATHLEEN M HARRIS [JONES] (John's four-times-great-grandson's wife) was born in 1942. See family tree 42.
Thomas L HARRIS²⁵⁵ married Kathleen M HARRIS [JONES]. They had three children:
Richard HARRIS⁹⁵
Edward HARRIS⁹⁶
Jane HARRIS⁹⁷
This family is shown as family tree 42.
257. CHARLES DAVIES (John's four-times-great-grandson) was born to Trevor Glyn DAVIES⁴¹⁶ and Constance Minnie DAVIES [BYWATER]⁴¹⁵, as shown in family tree 91.
Charles married twice. He was married to Clare DAVIES²⁵⁸ and Ms. DAVIES²⁵⁹.
258. CLARE DAVIES (John's four-times-great-grandson's wife).
Charles DAVIES²⁵⁷ married Clare DAVIES.
259. MS. DAVIES (John's four-times-great-grandson's wife). See family tree 43.
Charles DAVIES²⁵⁷ married Ms. DAVIES. They had two children:
Ben DAVIES⁹⁸
Bethan DAVIES⁹⁹
This family is shown as family tree 43.
260. JULIE GRIFFITHS [DAVIES] (John's four-times-great-granddaughter) was born to Trevor Glyn DAVIES⁴¹⁶ and Constance Minnie DAVIES [BYWATER]⁴¹⁵, as shown in family tree 91.
261. MR. GRIFFITHS (John's four-times-great-granddaughter's husband). See family tree 44.
Mr. GRIFFITHS married Julie GRIFFITHS [DAVIES]²⁶⁰. They had one son:
Tim GRIFFITHS¹⁰⁰
This family is shown as family tree 44.
262. MAISIE ANNIE ROBERTS (John's four-times-great-granddaughter) was born to William Thomas ROBERTS⁴¹⁷ and Doris ROBERTS [MASON]⁴¹⁸, as shown in family tree 92.
Maisie married twice. She was married to Dr Tony WHATELEY²⁶³ and Barry GRIFFITHS²⁶⁴.
263. DR TONY WHATELEY (John's four-times-great-granddaughter's husband). See family tree 45.
Dr Tony WHATELEY married Maisie Annie ROBERTS²⁶². They had two daughters:
Julie Anne WHATELEY¹⁰¹ in 1969
Phillipa Anne WHATELEY¹⁰² in 1971
This family is shown as family tree 45.
264. BARRY GRIFFITHS (John's four-times-great-granddaughter's husband).
Barry GRIFFITHS married Maisie Annie ROBERTS²⁶².
265. ELIZABETH MARY (BETTY) WEBB [ROBERTS] (John's four-times-great-granddaughter) was born to William Thomas ROBERTS⁴¹⁷ and Doris ROBERTS [MASON]⁴¹⁸, as shown in family tree 92.
266. DAVID WEBB (John's four-times-great-granddaughter's husband). See family tree 46.
David WEBB married Elizabeth Mary (Betty) WEBB [ROBERTS]²⁶⁵. They had two children:
Alan WEBB¹⁰³
Jane WEBB¹⁰⁵
This family is shown as family tree 46.
267. JOYCE ROBERTS (John's four-times-great-granddaughter) was born to James Albert ROBERTS⁴²⁰ and Annie ROBERTS [WILLIAMS]⁴²¹, as shown in family tree 93.

268. DOREEN ROBERTS (John's four-times-great-granddaughter) was born to James Albert ROBERTS⁴²⁰ and Annie ROBERTS [WILLIAMS]⁴²¹, as shown in family tree 93.
269. NEWTON ROBERTS (John's four-times-great-grandson) was born to James Albert ROBERTS⁴²⁰ and Annie ROBERTS [WILLIAMS]⁴²¹, as shown in family tree 93.
 Newton fathered one son:
 Andrew William ROBERTS¹⁰⁶ in 1946
This family is shown as family tree 47.
270. CALEB THOMAS ROBERTS (John's four-times-great-grandson) was born to William Caleb ROBERTS⁴²² and Mona A ROBERTS [PLAIN]⁴²³, as shown in family tree 94.
 Caleb fathered one son:
 Andrew William ROBERTS¹⁰⁷ in 1946
This family is shown as family tree 48.
271. MURIEL DOREEN LLOYD (John's four-times-great-granddaughter) was born in 1937 to Muriel Annie (Dolly) LLOYD⁴²⁴, as shown in family tree 95.
 Muriel married twice. She was married to Derek BROWN²⁷² and Donald BURCHILL²⁷³.
 Note: *Note 3.*
272. DEREK BROWN (John's four-times-great-granddaughter's husband) was born in 1934. See family tree 49. Derek died in 2000, aged about 66.
 Derek BROWN married Muriel Doreen LLOYD²⁷¹. They had six children:
 Jeanne BOWERS [BROWN]¹⁰⁸ in 1956
 Carol BROWN¹¹⁰ in 1957
 Alison LEWIS [BROWN]¹¹¹ in 1959
 Wynn BROWN¹¹³ in 1960
 Nigel BROWN¹¹⁵ in 1962
 Claire DORWOOD [BROWN]¹¹⁶ in 1967
This family is shown as family tree 49.
273. DONALD BURCHILL (John's four-times-great-granddaughter's husband) was born in 1924.
 Donald BURCHILL, aged about 80, married Muriel Doreen LLOYD²⁷¹, aged about 67, in 2004.
274. MR. PICKERSGILL (John's four-times-great-grandson) was born to Mr. PICKERSGILL⁴²⁶ and Gwendoline Dilys PICKERSGILL [LLOYD]⁴²⁵, as shown in family tree 96.
275. JENNY TAIT (John's four-times-great-granddaughter) was born to Mr. TAIT⁴²⁸ and Kathleen Florence Martha TAIT [LLOYD]⁴²⁷, as shown in family tree 97.
276. ALAN TAIT (John's four-times-great-grandson) was born to Mr. TAIT⁴²⁸ and Kathleen Florence Martha TAIT [LLOYD]⁴²⁷, as shown in family tree 97.
277. MR. TAIT (John's four-times-great-grandson) was born to Mr. TAIT⁴²⁸ and Kathleen Florence Martha TAIT [LLOYD]⁴²⁷, as shown in family tree 97.
278. MR. HARRIS (John's four-times-great-grandson) was born to Mr. HARRIS⁴³⁰ and Margaret Maisie HARRIS [LLOYD]⁴²⁹, as shown in family tree 98.
279. MR. HARRIS (John's four-times-great-grandson) was born to Mr. HARRIS⁴³⁰ and Margaret Maisie HARRIS [LLOYD]⁴²⁹, as shown in family tree 98.
280. JAMES DAVIES (John's four-times-great-grandson) was born in 1937 to Mr. DAVIES⁴³² and Mercia Willoughby DAVIES [LLOYD]⁴³¹, as shown in family tree 99.
281. MEIC STEPHENS MA DLITT (John's four-times-great-grandson) was born in 1938, in Treforest, to Herbert Arthur LLOYD - STEPHENS⁴³⁴ and Alma LLOYD - STEPHENS [SYMES]⁴³⁵, as shown in family tree 100. Meic was educated (University College, Aberystwyth). He became a Professor. Welsh writing in English.
 Note: *Note 4.*
282. RUTH WYNN STEPHENS [MEREDITH] (John's four-times-great-grandson's wife) was born in 1938. See family tree 50.
 Meic STEPHENS MA Dllitt²⁸¹, aged about 27, married Ruth Wynn STEPHENS [MEREDITH], aged about 27, in 1965. They had four children:
 Lowri Angharad EVANS [STEPHENS]¹¹⁸ in 1966
 Heledd Melangell DAY [STEPHENS]¹²⁰ in 1968
 Brengain Gwenllian EVANS [STEPHENS]¹²² in 1969
 Huw Meredydd STEPHENS¹²⁴ in 1981
This family is shown as family tree 50.

283. LLOYD STEPHENS (John's four-times-great-grandson) was born in 1943 to Herbert Arthur LLOYD - STEPHENS⁴³⁴ and Alma LLOYD - STEPHENS [SYMES]⁴³⁵, as shown in family tree 100.
284. MARGARET PATRICIA ISMAY STEPHENS [MORRIS] (John's four-times-great-grandson's wife) was born in 1940. See family tree 51.

Lloyd STEPHENS²⁸³, aged about 22, married Margaret Patricia Ismay STEPHENS [MORRIS], aged about 25, in 1965. They had three children:

Sian CORRIE [STEPHENS]¹²⁵ in 1967

Neil STEPHENS¹²⁷

Ceri STEPHENS¹²⁹ in 1978

This family is shown as family tree 51.

285. AUBREY E MICHAEL PRITCHETT (John's four-times-great-grandson) was born to Aubrey PRITCHETT⁴³⁸ and Annie Matilda (Nan) PRITCHETT [EVES]⁴³⁷, as shown in family tree 101. Aubrey became a Farmer.
286. JANET PRITCHETT [BEASLEY] (John's four-times-great-grandson's wife). See family tree 52.

Aubrey E Michael PRITCHETT²⁸⁵ married Janet PRITCHETT [BEASLEY] in 1953 in Cirencester. They had two children:

Bruce PRITCHETT¹³⁰ in 1957

Jill BACE [PRITCHETT]¹³²

This family is shown as family tree 52.

287. PHILIP LANE (John's four-times-great-grandson) was born on 7 May 1950 to Tom Evan LANE⁴³⁹ and Irene LANE [BALLINGER]⁴⁴⁰, as shown in family tree 102. Philip became a Composer Of Music.



288. SUSAN LANE (John's four-times-great-grandson's wife). See family tree 53.

Philip LANE²⁸⁷ married Susan LANE. They had two children:

Timothy LANE¹³⁴ in 1982

Camilla LANE¹³⁵ in 1982

This family is shown as family tree 53.

289. RACHEL TURNER [LANE] (John's four-times-great-granddaughter) was born on 12 October 1953 to Tom Evan LANE⁴³⁹ and Irene LANE [BALLINGER]⁴⁴⁰, as shown in family tree 102.

290. ROBERT TURNER (John's four-times-great-granddaughter's husband).

Note: Note 5.

Robert TURNER married Rachel TURNER [LANE]²⁸⁹.



291. DAVID PHILIP JOHN LLOYD CENG, CITP, MBCS., MAPM (John's four-times-great-grandson) was born on 9 September 1959, in Guildford, Surrey, to John LLOYD⁴⁴³ and Beryl Kathryn LLOYD [MILLER]⁴⁴⁴, as shown in family tree 103. David was educated (Market Harborough Grammar School, BRNC Dartmouth). He resided at David Philip John LLOYD CEng, MBCS, CITP, MAPM. He resided at 54 Penhale Gardens, Titchfield Common, Fareham, Hampshire 24 March 1984 - January 1986. David resided at 2 Bell Davis Road, Hillhead, Fareham, Hampshire January 1986 - October 1989. He resided at 5 Bell Davies Road, Hillhead, Fareham, Hampshire PO12 October 1989 - September 1992. He resided at 28b Europa Flats, Gibraltar September 1992 - August 1995. David resided at Rivendell, Norton St Phillip, Somerset August 1995 - January 1997. He resided at Little Orchard, Court Lane, Corsley, Wiltshire January 1997 - August 1998. He resided at 3 Fort Terrace, Plymouth, Devon, PL6 5BU August 1998 - October 2003. David resided at 6 Invincible Rd, Hillhead, Fareham, Hampshire, PO14 2AZ 12 Oct 2003 - 21 Dec 2006. He resided at 5 St Andrews Rd, Gosport, Hampshire, PO12 1QA, 21 Dec 2006 -.

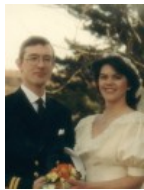

The following information is also recorded for David. Religion: Baptist.

Note: Note 6.

292. MARIA ALEXANDRA LLOYD [BUBEAR] RGN RMN (John's four-times-great-grandson's wife) was born on 28 March 1956, in Keynsham, Somerset, to Jack BUBEAR and Margaret Emma Milton BUBEAR [SHOUT]. See family tree 54. Maria was educated (South East Northumberland Technical College). She became a Senior Nursing Officer, QARNNS (SRN RMN). She resided at Maria Alexandra BUBEAR RGN RMN.

The following information is also recorded for Maria. Religion: United Reform.

Note: Note 7.

David Philip John LLOYD CEng, CITP, MBCS, MAPM²⁹¹, aged 24, married Maria Alexandra LLOYD [BUBEAR] RGN RMN, aged 27, on 24 March 1984 in St Luke's Chapel, Royal Naval Hospital Haslar, Gosport, Hants. They had three daughters:

Emily Rebekah LLOYD¹³⁶ in 1986
 Jessica Alys Sykes [LLOYD]¹³⁷ in 1987
 Victoria Alexandra LLOYD¹³⁹ in 1989

This family is shown as family tree 54.

293. PETER GEOFFREY LLOYD (John's four-times-great-grandson) was born on 27 May 1962, in Alcester, Warwickshire, to John LLOYD⁴⁴³ and Beryl Kathryn LLOYD [MILLER]⁴⁴⁴, as shown in family tree 103. Peter was educated (Robert Smyth School, Mkt Harboro, Westminster College Oxford). He became a Teacher.



The following information is also recorded for Peter. Religion: Baptist.

Note: Note 8.

294. KAREN MARGARET LLOYD [DAWE] (John's four-times-great-grandson's wife) was born on 15 June 1967, in Tavistock, Devon. See family tree 55. She was christened in Lew Trenchard, Devon. She became a Bio Chemist.

The following information is also recorded for Karen. Religion: Baptist.

Peter Geoffrey LLOYD²⁹³, aged 30, married Karen Margaret LLOYD [DAWE], aged 25, on 3 April 1993 in Lew Trenchard, Devon. They had two children:

John James LLOYD¹⁴⁰ in 1999
 Naomi Ruth LLOYD¹⁴¹ in 2003

This family is shown as family tree 55.

295. WING CDR ANDREW ROBERT LLOYD RAF (John's four-times-great-grandson) was born on 28 October 1967, in Leicester, to John LLOYD⁴⁴³ and Beryl Kathryn LLOYD [MILLER]⁴⁴⁴, as shown in family tree 103. Andrew was educated (Robert Smyth School, Mkt Harbo, RAF College, Cranwell). He became a RAF.



The following information is also recorded for Andrew. Religion: Baptist.

296. CHERYL ESTHER LLOYD [DUGGAN] (John's four-times-great-grandson's wife) was born on 5 May 1964, in Taunton, UK. See family tree 56. Cheryl became a WRAF, Estate Agent.

Andrew Robert LLOYD RAF²⁹⁵, aged 29, married Cheryl Esther LLOYD [DUGGAN], aged 33, on 28 June 1997 in All Saints Church, Longhope, Gloucestershire. They had two daughters:

Bethany Esther LLOYD¹⁴² in 1999
 Josie LLOYD¹⁴³ in 2003

This family is shown as family tree 56.

297. DR KATHRYN ANN LEWIS [BOWS] BMEDSCI, BM, BS (John's four-times-great-granddaughter) was born on 18 September 1956, in Kensington, UK, to Raymond George (Bill) BOWS BA⁴⁴⁸ and Annie Mabel (Nancy) BOWS [LLOYD] BA⁴⁴⁷, as shown in family tree 104. Kathryn became a MD.

298. ROBIN LEWIS (John's four-times-great-granddaughter's husband). See family tree 57.



Robin LEWIS married Kathryn Ann LEWIS [BOWS] BMedSci, BM, BS²⁹⁷, aged 29, in July 1986 in Newark. They had three children:

Benjamin Thomas LEWIS¹⁴⁴ in 1987
 Rhiannon Jayne LEWIS¹⁴⁵ in 1989
 Anneli Rachel LEWIS¹⁴⁶ in 1992

This family is shown as family tree 57.

299. WNG CDR RICHARD BOWS RAF (RETD) (John's four-times-great-grandson) was born on 23 September 1959 to Raymond George (Bill) BOWS BA⁴⁴⁸ and Annie Mabel (Nancy) BOWS [LLOYD] BA⁴⁴⁷, as shown in family tree 104. Richard became a RAF Dentist.







300. TERRI BOWS [EASTWOOD] (John's four-times-great-grandson's wife). See family tree 58.

Richard BOWS RAF (Retd)²⁹⁹, aged 25, married Terri BOWS [EASTWOOD] on 7 September 1985. They had three daughters:

Sarah Louise BOWS¹⁴⁷ in 1986
 Laura Anne BOWS¹⁴⁸ in 1989
 Nicola Christina BOWS¹⁴⁹ in 1993

This family is shown as family tree 58.

301. CHARLES EDWARD LLOYD BOWS MA (John's four-times-great-grandson) was born on 28 July 1967 to Raymond George (Bill) BOWS BA⁴⁴⁸ and Annie Mabel (Nancy) BOWS [LLOYD] BA⁴⁴⁷, as shown in family tree 104.
302. HUGH DAVID LLOYD (John's four-times-great-grandson) was born in February 1986 to David Kingsley LLOYD⁴⁴⁹ and Susan M LLOYD [MURRAY]⁴⁵⁰, as shown in family tree 105.
303. JACOB KINGSLEY LLOYD (John's four-times-great-grandson) was born in 1988 to David Kingsley LLOYD⁴⁴⁹ and Susan M LLOYD [MURRAY]⁴⁵⁰, as shown in family tree 105.
304. BETHAN LAURA LLOYD (John's four-times-great-granddaughter) was born in April 1990 to David Kingsley LLOYD⁴⁴⁹ and Susan M LLOYD [MURRAY]⁴⁵⁰, as shown in family tree 105.
305. DAVID HARDWICK (John's four-times-great-grandson) was born to Tom HARDWICK⁴⁵³ and Kathleen HARDWICK [LLOYD]⁴⁵², as shown in family tree 106.
306. STEPHEN GARETH LLOYD BSC, D.C (John's four-times-great-grandson) was born on 23 September 1953, in Hereford, UK, to Sidney Walter Gordon LLOYD⁴⁵⁴ and Peggy LLOYD [SIMMONS]⁴⁵⁵, as shown in family tree 107. Stephen was educated (Leominster, Minster School; Portsmouth Polytechnic; Anglo European Chiropractic College, Bournemouth). He became a Chiropractor.

 Note: *Note 9.*
307. REVEREND JULIET LLOYD [DENMAN] GRAD DIP TH (John's four-times-great-grandson's wife) was born on 14 March 1957, in Warlingham, Surrey. See family tree 59. Juliet was educated (Durrington High, Portsmouth Poly, Weymouth College of Ed, South Wales Baptist College, Cardiff University). She became a Mathematics Teacher, Baptist Minister at Stanwell rd Baptist Church, Penarth.

 The following information is also recorded for Juliet. Religion: Baptist.
 Stephen Gareth LLOYD BSc, D.C.³⁰⁶, aged 23, married Juliet LLOYD [DENMAN] Grad Dip TH, aged 20, on 3 September 1977 in Worthing. They had two daughters:
 Eleanor Joy HOLLAND [LLOYD] LLB (Oxon), LLM¹⁵⁰ in 1985
 Kathryn Louise LLOYD BA, MA¹⁵² in 1986
This family is shown as family tree 59.
308. REVEREND PETER ADRIAN LLOYD (John's four-times-great-grandson) was born on 25 November 1956, in Hereford, UK, to Sidney Walter Gordon LLOYD⁴⁵⁴ and Peggy LLOYD [SIMMONS]⁴⁵⁵, as shown in family tree 107. Peter was educated (Leominster Minster School, St Paul's College, Cheltenham, Northumbria Bible College). He became an Initially A Teacher, Later A Baptist Minister.

 The following information is also recorded for Peter. Religion: Baptist.
 Note: *Note 10.*
309. CATHERINE LLOYD [FOLEY] (John's four-times-great-grandson's wife) was born on 24 October 1956, in Hereford, UK. See family tree 60.
 Peter Adrian LLOYD³⁰⁸, aged 27, married Catherine LLOYD [FOLEY], aged 27, on 21 July 1984 in Leominster Baptist Chapel. They had two children:
 Samuel Peter LLOYD¹⁵³ in 1986
 Kezia Catherine Faith LLOYD¹⁵⁴ in 1998
This family is shown as family tree 60.
310. HEATHER JOY LLOYD (John's four-times-great-granddaughter) was born on 5 September 1959, in Hereford, UK, to Sidney Walter Gordon LLOYD⁴⁵⁴ and Peggy LLOYD [SIMMONS]⁴⁵⁵, as shown in family tree 107. Heather was educated (Leominster School). She was a Police, Voluntary Worker in Orphanage, Mozambique (2005). Heather died on 23 February 2008, aged 48, in Hereford, UK.
 Note: *Note 11.*
311. CHRISTINE ELIZABETH MENCHENICK [STRATTON] (John's four-times-great-granddaughter) was born on 30 October 1946 to John Arthur STRATTON⁴⁵⁷ and Hannah Heslop STRATTON [MACAULAY]⁴⁵⁸, as shown in family tree 108.
312. GORDON MENCHENICK (John's four-times-great-granddaughter's husband).
 Gordon MENCHENICK married Christine Elizabeth MENCHENICK [STRATTON]³¹¹, aged about 56, in 2003.
313. BRONWEN DOROTHY STRATTON (John's four-times-great-granddaughter) was born on 29 September 1948 to John Arthur STRATTON⁴⁵⁷ and Hannah Heslop STRATTON [MACAULAY]⁴⁵⁸, as shown in family tree 108. Bronwen married twice. She was married to David EARTHROWL³¹⁴ and John BUNTING³¹⁵.

314. DAVID EARTHROWL (John's four-times-great-granddaughter's husband) was born on 25 February 1936. See family tree 61.
David married twice. He was married to Sheila EARTHROWL [HILL] and Bronwen Dorothy STRATTON³¹³.
David EARTHROWL married Sheila EARTHROWL [HILL]. They had two children:
Lewis EARTHROWL
Victoria EARTHROWL
This family is shown as family tree 61.
David EARTHROWL married Bronwen Dorothy STRATTON³¹³, and they were divorced in 2000, when aged 64 and 51 respectively. They had two sons:
Tomos EARTHROWL¹⁵⁵ in 1973
James Edward EARTHROWL¹⁵⁶ in 1975
This family is shown as family tree 61.
315. JOHN BUNTING (John's four-times-great-granddaughter's husband).
John BUNTING married Bronwen Dorothy STRATTON³¹³, aged about 52, in 2001.
316. GWENLLIAN KNIGHTON [ROBERTS] (John's four-times-great-granddaughter) was born on 18 August 1950 to Robert Owen ROBERTS⁴⁶⁰ and Edith Megan ROBERTS [STRATTON]⁴⁵⁹, as shown in family tree 109. Gwenllian became a Deaconess.
The following information is also recorded for Gwenllian. Religion: Methodist.
- 
317. DONALD GEORGE KNIGHTON REVEREND (John's four-times-great-granddaughter's husband) was born in 1932.
Donald became a Minister.
The following information is also recorded for Donald. Religion: Methodist.
Donald married twice. He was married to Gwenllian KNIGHTON [ROBERTS]³¹⁶ and Anne Mary KNIGHTON [EVANS].
Donald George KNIGHTON Reverend, aged about 61, married Gwenllian KNIGHTON [ROBERTS]³¹⁶, aged 43, in February 1994.
Donald George KNIGHTON Reverend married Anne Mary KNIGHTON [EVANS]. They had three children:
Rachel KNIGHTON
Daniel Unknown
Benjamin Unknown
318. JANET LEWIS [ROBERTS-LEWIS] (John's four-times-great-granddaughter) was born on 22 March 1955 to Robert Owen ROBERTS⁴⁶⁰ and Edith Megan ROBERTS [STRATTON]⁴⁵⁹, as shown in family tree 109.
319. REVEREND CHRISTOPHER ILLTYD LEWIS (John's four-times-great-granddaughter's husband). See family tree 62.
Christopher became a Baptist Minister.
Christopher Illtyd LEWIS married Janet LEWIS [ROBERTS-LEWIS]³¹⁸, aged about 26, in 1981. They had three children:
Megan Elizabeth ROBERTS-LEWIS¹⁵⁷ in 1983
Timothy John ROBERTS-LEWIS¹⁵⁸ in 1985
Cerian ROBERTS-LEWIS¹⁵⁹ in 1989
This family is shown as family tree 62.
320. JOHN JONES (John's four-times-great-grandson) was born to Harold Henry JONES⁴⁸⁴ and Dorothy May JONES [POWELL]⁴⁸³, as shown in family tree 110.
321. SANDRA JONES [MORGAN] (John's four-times-great-grandson's wife). See family tree 63.
John JONES³²⁰ married Sandra JONES [MORGAN]. They had two daughters:
Charlotte JONES¹⁶⁰
Rebecca JONES¹⁶¹
This family is shown as family tree 63.
322. ROBERT JONES (John's four-times-great-grandson) was born to Harold Henry JONES⁴⁸⁴ and Dorothy May JONES [POWELL]⁴⁸³, as shown in family tree 110.
323. NICOLA JONES [EVANS] (John's four-times-great-grandson's wife). See family tree 64.
Robert JONES³²² married Nicola JONES [EVANS]. They had three daughters:
Jessica JONES¹⁶²
Sophia JONES¹⁶³
Harriet JONES¹⁶⁴
This family is shown as family tree 64.
324. ANN BLANDFORD [JONES] (John's four-times-great-granddaughter) was born to Harold Henry JONES⁴⁸⁴ and Dorothy May JONES [POWELL]⁴⁸³, as shown in family tree 110.

325. TIMOTHY BLANDFORD (John's four-times-great-granddaughter's husband). See family tree 65. Timothy BLANDFORD married Ann BLANDFORD [JONES]³²⁴. They had three children:
 Toby BLANDFORD¹⁶⁵
 Henry BLANDFORD¹⁶⁶
 Jane BLANDFORD¹⁶⁷
This family is shown as family tree 65.
326. JENNY INGRAM (John's four-times-great-granddaughter) was born in 1960 to George James INGRAM⁴⁸⁶ and Gwendoline Jane (Babs) INGRAM [POWELL]⁴⁸⁵, as shown in family tree 111.
327. JOHN POWELL (John's four-times-great-grandson) was born to Thomas John POWELL⁴⁸⁷ and Enid POWELL [GORE]⁴⁸⁸, as shown in family tree 112.
328. PHILIP POWELL (John's four-times-great-grandson) was born in 1965 to Thomas John POWELL⁴⁸⁷ and Enid POWELL [GORE]⁴⁸⁸, as shown in family tree 112.
329. GRAHAM POWELL (John's four-times-great-grandson) was born in 1972 to Thomas John POWELL⁴⁸⁷ and Enid POWELL [GORE]⁴⁸⁸, as shown in family tree 112.
330. LYNDA PRICE (John's four-times-great-granddaughter) was born in 1962 to William Mervyn PRICE⁴⁹⁰ and Elizabeth Rachel PRICE [POWELL]⁴⁸⁹, as shown in family tree 113.
331. DAVID PRICE (John's four-times-great-grandson) was born in 1966 to William Mervyn PRICE⁴⁹⁰ and Elizabeth Rachel PRICE [POWELL]⁴⁸⁹, as shown in family tree 113.
332. M PRICE (John's four-times-great-granddaughter) was born in 1971 to William Mervyn PRICE⁴⁹⁰ and Elizabeth Rachel PRICE [POWELL]⁴⁸⁹, as shown in family tree 113.
333. MARGARET POWELL (John's four-times-great-granddaughter) was born in 1968 to Kenneth Charles POWELL⁴⁹¹ and Ruth POWELL [PUGH]⁴⁹², as shown in family tree 114.
334. ANDREW POWELL (John's four-times-great-grandson) was born in 1970 to Kenneth Charles POWELL⁴⁹¹ and Ruth POWELL [PUGH]⁴⁹², as shown in family tree 114.
335. RICHARD DAVIES (John's four-times-great-grandson) was born to Jeffrey DAVIES⁴⁹⁴ and Edith Margaret DAVIES [POWELL]⁴⁹³, as shown in family tree 115.
336. RODERICK DAVIES (John's four-times-great-grandson) was born to Jeffrey DAVIES⁴⁹⁴ and Edith Margaret DAVIES [POWELL]⁴⁹³, as shown in family tree 115.
337. CHRISTOPHER POWELL (John's four-times-great-grandson) was born to Eithel Pugh POWELL⁴⁹⁶ and Lena Mary POWELL⁴⁹⁵, as shown in family tree 116.
338. LYNETTE POWELL (John's four-times-great-granddaughter) was born to Eithel Pugh POWELL⁴⁹⁶ and Lena Mary POWELL⁴⁹⁵, as shown in family tree 116.
339. LORRAINE POWELL (John's four-times-great-granddaughter) was born to Eithel Pugh POWELL⁴⁹⁶ and Lena Mary POWELL⁴⁹⁵, as shown in family tree 116.
340. ROGER BOWEN (John's four-times-great-grandson) was born to Gilbert Samuel BOWEN⁴⁹⁸ and Jeanette BOWEN [POWELL]⁴⁹⁷, as shown in family tree 117.
341. CLIVE BOWEN (John's four-times-great-grandchild) was born to Gilbert Samuel BOWEN⁴⁹⁸ and Jeanette BOWEN [POWELL]⁴⁹⁷, as shown in family tree 117.
342. STEVEN BADEN POWELL (John's four-times-great-grandson) was born to William Owen POWELL⁴⁹⁹ and Mary POWELL [LLOYD]⁵⁰⁰, as shown in family tree 118.
343. REBECCA BADEN POWELL (John's four-times-great-granddaughter) was born to William Owen POWELL⁴⁹⁹ and Mary POWELL [LLOYD]⁵⁰⁰, as shown in family tree 118. Rebecca became a Physiotherapist (Bonesetter?).
344. JANE HARRISON [POWELL] (John's four-times-great-granddaughter) was born to Robert Lloyd POWELL⁵⁰¹ and Christine POWELL [LEWIS]⁵⁰², as shown in family tree 119.
345. KARL HARRISON (John's four-times-great-granddaughter's husband). See family tree 66.

Karl HARRISON married Jane HARRISON [POWELL]³⁴⁴. They had two children:

Ben HARRISON¹⁶⁸

Tia HARRISON¹⁶⁹

This family is shown as family tree 66.

346. CLARE TUFT [POWELL] (John's four-times-great-granddaughter) was born to Robert Lloyd POWELL⁵⁰¹ and Christine POWELL [LEWIS]⁵⁰², as shown in family tree 119.

347. STEPHEN TUFT (John's four-times-great-granddaughter's husband). See family tree 67.

Stephen TUFT married Clare TUFT [POWELL]³⁴⁶. They had three children:

Eva TUFT¹⁷⁰

Sally TUFT¹⁷¹

Joel TUFT¹⁷²

This family is shown as family tree 67.

348. ANNA POWELL (John's four-times-great-granddaughter) was born to Robert Lloyd POWELL⁵⁰¹ and Christine POWELL [LEWIS]⁵⁰², as shown in family tree 119.

349. JUDITH ILES (John's four-times-great-granddaughter) was born to Derek ILES⁵⁰⁴ and Ms. ILES [POWELL]⁵⁰³, as shown in family tree 120.

350. LOIS ILES (John's four-times-great-granddaughter) was born to Derek ILES⁵⁰⁴ and Ms. ILES [POWELL]⁵⁰³, as shown in family tree 120.

351. KENNETH (KEN) WILLIAMS (John's four-times-great-grandson) was born to Sid WILLIAMS⁵⁰⁷ and Phyllis WILLIAMS [JAMES]⁵⁰⁶, as shown in family tree 121.

352. VERA LINDSLEY WILLIAMS (John's four-times-great-grandson's wife). See family tree 68.

Kenneth (Ken) WILLIAMS³⁵¹ married Vera Lindsley WILLIAMS. They had one son:

Paul WILLIAMS¹⁷³ in 1975

This family is shown as family tree 68.

353. GLYN WILLIAMS (John's four-times-great-grandson) was born in 1945 to Sid WILLIAMS⁵⁰⁷ and Phyllis WILLIAMS [JAMES]⁵⁰⁶, as shown in family tree 121.

354. DILYS WILLIAMS [WATKINS] (John's four-times-great-grandson's wife). See family tree 69.

Glyn WILLIAMS³⁵³ married Dilys WILLIAMS [WATKINS]. They had three children:

Leslie WILLIAMS¹⁷⁴ in 1969

Michael WILLIAMS¹⁷⁶ in 1971

Lynette WILLIAMS¹⁷⁸ in 1973

This family is shown as family tree 69.

355. RITA HAZEL FARMER [JAMES] (John's four-times-great-granddaughter) was born on 8 November 1932, in Kington, to Mr. Unknown⁵⁰⁹ and Mary JAMES⁵⁰⁸, as shown in family tree 122.

356. HERBERT OLIVER FARMER (John's four-times-great-granddaughter's husband) was born in 1930. See family tree 70.

Herbert Oliver FARMER married Rita Hazel FARMER [JAMES]³⁵⁵. They had two children:

Theresa Louise AWAAD [FARMER]¹⁸⁰ in 1957

Adrian Oliver FARMER¹⁸² in 1962

This family is shown as family tree 70.

357. GWYNDAF LEWIS (John's four-times-great-grandson) was born to David LEWIS⁵¹⁰ and Mary JAMES⁵⁰⁸, as shown in family tree 123.

358. CAROL LEWIS (John's four-times-great-granddaughter) was born to David LEWIS⁵¹⁰ and Mary JAMES⁵⁰⁸, as shown in family tree 123.

359. AUSTIN THOMAS JAMES MORGAN (John's four-times-great-grandson) was born on 3 March 1941 to Thomas A MORGAN⁵¹³ and Margeurite J MORGAN [JAMES]⁵¹², as shown in family tree 124.

360. WINSTON BARRIE MORGAN (John's four-times-great-grandson) was born on 13 February 1951 to Thomas A MORGAN⁵¹³ and Margeurite J MORGAN [JAMES]⁵¹², as shown in family tree 124.

361. NANCY C MORGAN [TAYLOR] (John's four-times-great-grandson's wife). See family tree 71.

Winston Barrie MORGAN³⁶⁰, aged 36, married Nancy C MORGAN [TAYLOR] in July 1987. They had four children:

Thomas MORGAN¹⁸⁴ in 1988

Matthew MORGAN¹⁸⁵ in 1989

Nicola MORGAN¹⁸⁶ in 1993

Edward MORGAN¹⁸⁷ in 1996

This family is shown as family tree 71.

362. PEGGY LLOYD (John's four-times-great-granddaughter) was born in 1942 to Walter LLOYD⁵¹⁵ and Dorothy Clare LLOYD [DAVIES]⁵¹⁶, as shown in family tree 125.
363. CARMEN LLOYD (John's four-times-great-granddaughter) was born in 1944 to Walter LLOYD⁵¹⁵ and Dorothy Clare LLOYD [DAVIES]⁵¹⁶, as shown in family tree 125.
364. JOHN DUGGAN (John's four-times-great-grandson) was born to John (Jack) E DUGGAN⁵²⁰ and Emily Maud DUGGAN [LLOYD]⁵¹⁹, as shown in family tree 126.
365. JEAN DUGGAN (John's four-times-great-granddaughter) was born to John (Jack) E DUGGAN⁵²⁰ and Emily Maud DUGGAN [LLOYD]⁵¹⁹, as shown in family tree 126.
366. ELIZABETH ANNE NEWTON [LLOYD] (John's four-times-great-granddaughter) was born on 21 March 1952 to Evan Rice LLOYD⁵²¹ and Hilda LLOYD⁵²², as shown in family tree 127.
367. ROGER JOHN NEWTON (John's four-times-great-granddaughter's husband) was born on 21 December 1947. See family tree 72.
 Roger John NEWTON married Elizabeth Anne NEWTON [LLOYD]³⁶⁶. They had two children:
 Anthony Paul NEWTON¹⁸⁸ in 1970
 Amanda Louise NEWTON¹⁹⁰ in 1975
This family is shown as family tree 72.
368. DAVID EVAN LLOYD (John's four-times-great-grandson) was born on 18 February 1954 to Evan Rice LLOYD⁵²¹ and Hilda LLOYD⁵²², as shown in family tree 127.
369. IRENE LLOYD [DURRELL] (John's four-times-great-grandson's wife). See family tree 73.
 David Evan LLOYD³⁶⁸ married Irene LLOYD [DURRELL]. They had four children:
 Cassie LLOYD¹⁹¹
 Sean LLOYD¹⁹²
 Sophie LLOYD¹⁹³
 Christopher LLOYD¹⁹⁴
This family is shown as family tree 73.
370. ROBERT LLOYD (John's four-times-great-grandson) was born to Henry Charles LLOYD⁵²³ and Enid A LLOYD [BAKER]⁵²⁴, as shown in family tree 128.
371. GRAHAM C LLOYD (John's four-times-great-grandson) was born to Henry Charles LLOYD⁵²³ and Enid A LLOYD [BAKER]⁵²⁴, as shown in family tree 128.
372. WENDY LLOYD [WILLIAMS] (John's four-times-great-grandson's wife). See family tree 74.
 Graham C LLOYD³⁷¹ married Wendy LLOYD [WILLIAMS] in 1974 in Kington. They had three children:
 Jane LLOYD¹⁹⁵
 Paul LLOYD¹⁹⁶
 Gareth LLOYD¹⁹⁷
This family is shown as family tree 74.
 Note: Q3 (Marriage).
373. ANITA JANE SKYRME [POWELL] (John's four-times-great-granddaughter) was born on 26 September 1963 to David POWELL⁵²⁶ and Joan POWELL [LLOYD]⁵²⁵, as shown in family tree 129.
374. RICHARD PHILIP SKYRME (John's four-times-great-granddaughter's husband). See family tree 75.
 Richard Philip SKYRME married Anita Jane SKYRME [POWELL]³⁷³. They had two children:
 Chloe Jane SKYRME¹⁹⁸ in 1994
 Richard David SKYRME¹⁹⁹ in 1997
This family is shown as family tree 75.
375. KATHRYN ANN WILLIAMS [POWELL] (John's four-times-great-granddaughter) was born on 5 March 1966 to David POWELL⁵²⁶ and Joan POWELL [LLOYD]⁵²⁵, as shown in family tree 129.
376. CHRISTOPHER JOHN WILLIAMS (John's four-times-great-granddaughter's husband). See family tree 76.
 Christopher John WILLIAMS married Kathryn Ann WILLIAMS [POWELL]³⁷⁵. They had two children:
 Eleanor Ann WILLIAMS²⁰⁰ in 1998
 Jack Rhys WILLIAMS²⁰¹ in 1999
This family is shown as family tree 76.

377. ALAN HUGH LLOYD (John's four-times-great-grandson) was born on 29 November 1948, in Quebb Farm, Eardisley, to Hugh LLOYD⁵³⁸ and Eva Grace LLOYD [MORRIS]⁵³⁹, as shown in family tree 130.



378. SARAH MARIE LLOYD [GOUGH] (John's four-times-great-grandson's wife) was born on 2 December 1952, in Maidenhead. See family tree 77.

Alan Hugh LLOYD³⁷⁷ married Sarah Marie LLOYD [GOUGH]. They had two daughters:

Sarah Julia LLOYD²⁰² in 1978

Jessica Helen LLOYD²⁰³ in 1989

This family is shown as family tree 77.

379. ELWYN JOHN LLOYD (John's four-times-great-grandson) was born on 30 June 1952, in Great Quebb, Eardisley, to Hugh LLOYD⁵³⁸ and Eva Grace LLOYD [MORRIS]⁵³⁹, as shown in family tree 130.

380. JANE LLOYD [HYATT] (John's four-times-great-grandson's wife) was born on 11 June 1953, in Wellington, Hereford. See family tree 78.

Elwyn John LLOYD³⁷⁹, aged 22, married Jane LLOYD [HYATT], aged 21, on 19 April 1975. They had two daughters:

Frances Isabel LLOYD²⁰⁴ in 1979

Jocelyn Ruth LLOYD²⁰⁵ in 1982

This family is shown as family tree 78.

381. IAN PHILLIPS (John's four-times-great-grandson) was born on 15 November 1951 to Victor Evan PHILLIPS⁵⁴¹ and Doris PHILLIPS [LLOYD]⁵⁴⁰, as shown in family tree 131.

382. PAMELA PHILLIPS [SPAREY] (John's four-times-great-grandson's wife) was born in 1953. See family tree 79.

Ian PHILLIPS³⁸¹, aged about 23, married Pamela PHILLIPS [SPAREY], aged about 22, in 1975. They had three sons:

Jamie PHILLIPS²⁰⁶ in 1977

Robert PHILLIPS²⁰⁷ in 1980

Peter PHILLIPS²⁰⁸ in 1983

This family is shown as family tree 79.

383. COLIN PHILLIPS (John's four-times-great-grandson) was born in November 1954 to Victor Evan PHILLIPS⁵⁴¹ and Doris PHILLIPS [LLOYD]⁵⁴⁰, as shown in family tree 131.

384. JANE PHILLIPS [EDWARDS] (John's four-times-great-grandson's wife) was born in 1952. See family tree 80.

Colin PHILLIPS³⁸³, aged about 27, married Jane PHILLIPS [EDWARDS], aged about 30, in 1982. They had three children:

Carrie PHILLIPS²⁰⁹

Rebecca PHILLIPS²¹⁰ in 1986

Daniel PHILLIPS²¹¹ in 1988

This family is shown as family tree 80.

385. JOHN H LEWIS (John's four-times-great-grandson) was born in 1959 to John LEWIS⁵⁴³ and Elizabeth Nancy LEWIS [LLOYD]⁵⁴², as shown in family tree 132.

386. LORRAINE LEWIS [PRICE] (John's four-times-great-grandson's wife). See family tree 81.

John H LEWIS³⁸⁵, aged about 26, married Lorraine LEWIS [PRICE] in June 1986. They had two children:

Kerry BOUNDS ? [LEWIS]²¹²

William LEWIS²¹⁴

This family is shown as family tree 81.

387. EDWARD PRICE (John's four-times-great-grandson) was born in 1967 to Edward PRICE⁵⁴⁵ and Margaret PRICE [LLOYD]⁵⁴⁴, as shown in family tree 133.

388. DAWN WILLIAMS [PRICE] (John's four-times-great-granddaughter) was born in 1970 to Edward PRICE⁵⁴⁵ and Margaret PRICE [LLOYD]⁵⁴⁴, as shown in family tree 133.

389. DAVID WILLIAMS (John's four-times-great-granddaughter's husband). See family tree 82.

David WILLIAMS married Dawn WILLIAMS [PRICE]³⁸⁸. They had two daughters:

Jemimah WILLIAMS²¹⁵

Georgia WILLIAMS²¹⁶

This family is shown as family tree 82.

390. MARCUS PRICE (John's four-times-great-grandson) was born in 1974 to Edward PRICE⁵⁴⁵ and Margaret PRICE [LLOYD]⁵⁴⁴, as shown in family tree 133.

Generation of Great-Great-Great-Grandchildren

391. EDMUND DREW (John's great-great-great-grandson) was born in 1907 to Edmund Danzey DREW⁵⁶⁰ and Margaret DREW [LLOYD]⁵⁵⁹, as shown in family tree 134. Edmund was a Bonesetter. Edmund died in 1991, aged about 84.
392. MARJORIE DREW (John's great-great-great-granddaughter) was born to Edmund Danzey DREW⁵⁶⁰ and Margaret DREW [LLOYD]⁵⁵⁹, as shown in family tree 134.
393. GLADYS DREW (John's great-great-great-granddaughter) was born to Edmund Danzey DREW⁵⁶⁰ and Margaret DREW [LLOYD]⁵⁵⁹, as shown in family tree 134.
394. DANZEY DREW (John's great-great-great-grandson) was born to Edmund Danzey DREW⁵⁶⁰ and Margaret DREW [LLOYD]⁵⁵⁹, as shown in family tree 134.
395. ELIZABETH MARY DREW (John's great-great-great-granddaughter) was born to Edmund Danzey DREW⁵⁶⁰ and Margaret DREW [LLOYD]⁵⁵⁹, as shown in family tree 134.
396. MINNIE SOPHIA DREW (John's great-great-great-grandson) was born to Edmund Danzey DREW⁵⁶⁰ and Margaret DREW [LLOYD]⁵⁵⁹, as shown in family tree 134.
397. MARY WILLIAMS (John's great-great-great-granddaughter) was born in 1901 to William WILLIAMS⁵⁶⁴ and Mary Ann (Polly) WILLIAMS [LLOYD]⁵⁶³, as shown in family tree 135.
398. RICHARD BYWATER (John's great-great-great-grandson) was born to Richard BYWATER⁵⁶⁷ and Sarah Rosa BYWATER [LLOYD]⁵⁶⁶, as shown in family tree 136.
Richard married twice. He was married to Mary Elizabeth BYWATER [THOMAS]³⁹⁹ and Phyllis BYWATER [ELLIS]⁴⁰⁰.
Note: *Note 12*.
399. MARY ELIZABETH BYWATER [THOMAS] (John's great-great-great-grandson's wife). See family tree 83. Mary died in 1938 in - 1939.
Richard BYWATER³⁹⁸ married Mary Elizabeth BYWATER [THOMAS]. They had three children:
Richard David BYWATER²¹⁷ in 1935
Darinda M FISHER [BYWATER]²¹⁹ in 1936
Margaret LEWIS [BYWATER]²²¹ in 1938
This family is shown as family tree 83.
400. PHYLLIS BYWATER [ELLIS] (John's great-great-great-grandson's wife). See family tree 84. Phyllis died on 24 June 1961.
Richard BYWATER³⁹⁸ married Phyllis BYWATER [ELLIS]. They had three children:
Phyllis Anne BYWATER²²³ in 1945
John Thomas BYWATER²²⁴ in 1946
Daphne BYWATER²²⁵ in 1948
This family is shown as family tree 84.
401. ROSA MARY BYWATER (John's great-great-great-granddaughter) was born in 1902, in Knighton, to Richard BYWATER⁵⁶⁷ and Sarah Rosa BYWATER [LLOYD]⁵⁶⁶, as shown in family tree 136. Rosa died in Diphtheria.
Notes:
• *Note 13*.
• *Q1 (Birth)*.
402. CALEB JAMES BYWATER (John's great-great-great-grandson) was born in 1902 to Richard BYWATER⁵⁶⁷ and Sarah Rosa BYWATER [LLOYD]⁵⁶⁶, as shown in family tree 136. Caleb was a Bonesetter. Caleb died in 1950, aged about 48.
403. DORIS BYWATER [WATKINS] (John's great-great-great-grandson's wife). See family tree 85. Doris died in 1976 in Ludlow, Shropshire.
Caleb James BYWATER⁴⁰² married Doris BYWATER [WATKINS]. They had four children:
John BYWATER²²⁶
Ruth JAMES [BYWATER]²²⁸ in 1936
Robin BYWATER BVMS, PhD²³⁰ in 1941
Sally PRICE [BYWATER]²³²
This family is shown as family tree 85.
404. ADAH MARGARET BYWATER (John's great-great-great-granddaughter) was born in 1903, in Knighton, to Richard BYWATER⁵⁶⁷ and Sarah Rosa BYWATER [LLOYD]⁵⁶⁶, as shown in family tree 136. Adah died in 1989, aged about 86.
Note: *Q2 (Birth)*.
405. JOHN (AKA JACK) BYWATER (John's great-great-great-grandson) was born in 1904, in Ludlow, Shropshire, to Richard

- BYWATER⁵⁶⁷ and Sarah Rosa BYWATER [LLOYD]⁵⁶⁶, as shown in family tree 136. John died in 1971, aged about 67, in Ludlow, Shropshire.
 Note: *Q2 (Birth; Death)*.
406. EDITH BYWATER [DAVIES] (John's great-great-great-grandson's wife). See family tree 86. Edith died in 1978. John (aka Jack) BYWATER⁴⁰⁵, aged about 27, married Edith BYWATER [DAVIES] in 1931. They had three children:
 John BYWATER²³⁴ in 1943
 Rosemary THOMAS [BYWATER]²³⁶ in 1946
 Richard BYWATER²³⁸ in 1949
This family is shown as family tree 86.
407. NAOMI MORRIS [BYWATER] (John's great-great-great-granddaughter) was born in 1907 to Richard BYWATER⁵⁶⁷ and Sarah Rosa BYWATER [LLOYD]⁵⁶⁶, as shown in family tree 136. Naomi was educated (Birmingham University). Naomi died in 1989, aged about 82.
 Note: *Note 14*.
408. WING CDR IRA MORRIS RAF (John's great-great-great-granddaughter's husband) was born in 1897. See family tree 87. Ira died in 1972, aged about 75.
 Ira MORRIS RAF, aged about 45, married Naomi MORRIS [BYWATER]⁴⁰⁷, aged about 35, in 1942. They had one son:
 Richard MORRIS²³⁹ in 1944
This family is shown as family tree 87.
409. THOMAS BYWATER (John's great-great-great-grandson) was born to Richard BYWATER⁵⁶⁷ and Sarah Rosa BYWATER [LLOYD]⁵⁶⁶, as shown in family tree 136. Thomas became a Professor of Agriculture (Aberdeen & Leeds).
410. ISHOBEL BYWATER [MCLELLAN MILLAR] (John's great-great-great-grandson's wife). See family tree 88. Thomas BYWATER⁴⁰⁹ married Ishobel BYWATER [MCLELLAN MILLAR]. They had three children:
 Murray Lloyd BYWATER²⁴¹ about 1940
 Judith Lloyd CLIFFORD [BYWATER]²⁴³
 Richard Lloyd BYWATER²⁴⁵ in 1943
This family is shown as family tree 88.
411. ROBERT DAVID BYWATER (John's great-great-great-grandson) was born in 1910 to Richard BYWATER⁵⁶⁷ and Sarah Rosa BYWATER [LLOYD]⁵⁶⁶, as shown in family tree 136. Robert died in 1993, aged about 83.
412. MARY BYWATER [NOTT] (John's great-great-great-grandson's wife). See family tree 89. Robert David BYWATER⁴¹¹ married Mary BYWATER [NOTT]. They had three sons:
 John BYWATER²⁴⁸ in 1943
 Geoffrey BYWATER²⁵⁰ in 1946
 Roger BYWATER²⁵¹ in 1947
This family is shown as family tree 89.
413. JOYCE SARAH HARRIS [BYWATER] (John's great-great-great-granddaughter) was born on 20 March 1914 to Richard BYWATER⁵⁶⁷ and Sarah Rosa BYWATER [LLOYD]⁵⁶⁶, as shown in family tree 136. Joyce died in 2000, aged about 86. She was buried in Beguildy.
414. EDWARD HARRIS (John's great-great-great-granddaughter's husband) was born in 1912. See family tree 90. Edward died in 1987, aged about 75. He was buried in Beguildy.
 Edward HARRIS, aged about 24, married Joyce Sarah HARRIS [BYWATER]⁴¹³, aged about 23, in the 2nd quarter of 1937 in Leominster, UK. They had two sons:
 Edward HARRIS²⁵³
 Thomas L HARRIS²⁵⁵ in 1944
This family is shown as family tree 90.
415. CONSTANCE MINNIE DAVIES [BYWATER] (John's great-great-great-granddaughter) was born on 12 July 1916, in Leominster, UK, to Richard BYWATER⁵⁶⁷ and Sarah Rosa BYWATER [LLOYD]⁵⁶⁶, as shown in family tree 136. Constance died in February 1994, aged 77, in Leominster, UK. She was buried in Brampton Bryan.
416. TREVOR GLYN DAVIES (John's great-great-great-granddaughter's husband) was born on 11 December 1934. See family tree 91. Trevor died in November 1989, aged 54, in Herefordshire. He was buried in Brampton Bryan.
 Trevor Glyn DAVIES married Constance Minnie DAVIES [BYWATER]⁴¹⁵. They had two children:
 Charles DAVIES²⁵⁷
 Julie GRIFFITHS [DAVIES]²⁶⁰
This family is shown as family tree 91.
417. WILLIAM THOMAS ROBERTS (John's great-great-great-grandson) was born in 1903 to William Owen ROBERTS⁵⁶⁹ and Ann Sophia ROBERTS [LLOYD]⁵⁶⁸, as shown in family tree 137. William died in 1956, aged about 53.
418. DORIS ROBERTS [MASON] (John's great-great-great-grandson's wife). See family tree 92.

William Thomas ROBERTS⁴¹⁷, aged about 32, married Doris ROBERTS [MASON] in 1935 in Radnorshire East, UK. They had two daughters:

Maisie Annie ROBERTS²⁶²

Elizabeth Mary (Betty) WEBB [ROBERTS]²⁶⁵

This family is shown as family tree 92.

419. GLADYS ANNE ROBERTS (John's great-great-great-granddaughter) was born in 1904 to William Owen ROBERTS⁵⁶⁹ and Ann Sophia ROBERTS [LLOYD]⁵⁶⁸, as shown in family tree 137. Gladys died in 1927, aged about 23.
Note: *Note 15.*

420. JAMES ALBERT ROBERTS (John's great-great-great-grandson) was born in 1906, in Knighton, to William Owen ROBERTS⁵⁶⁹ and Ann Sophia ROBERTS [LLOYD]⁵⁶⁸, as shown in family tree 137.
Note: *Q2 (Birth).*

421. ANNIE ROBERTS [WILLIAMS] (John's great-great-great-grandson's wife). See family tree 93.

James Albert ROBERTS⁴²⁰, aged about 24, married Annie ROBERTS [WILLIAMS] in 1930 in Knighton. They had three children:

Joyce ROBERTS²⁶⁷

Doreen ROBERTS²⁶⁸

Newton ROBERTS²⁶⁹

This family is shown as family tree 93.

Note: *Q4 (Marriage).*

422. WILLIAM CALEB ROBERTS (John's great-great-great-grandson) was born in 1910 to William Owen ROBERTS⁵⁶⁹ and Ann Sophia ROBERTS [LLOYD]⁵⁶⁸, as shown in family tree 137.

423. MONA A ROBERTS [PLAIN] (John's great-great-great-grandson's wife). See family tree 94.

William Caleb ROBERTS⁴²², aged about 33, married Mona A ROBERTS [PLAIN] in 1943 in Radnorshire East, UK. They had one son:

Caleb Thomas ROBERTS²⁷⁰

This family is shown as family tree 94.

Note: *Q2 (Marriage).*

424. MURIEL ANNIE (DOLLY) LLOYD (John's great-great-great-granddaughter) was born in 1913 to Hugh LLOYD⁵⁷³ and Florence LLOYD [HARLEY]⁵⁷⁴, as shown in family tree 138. Muriel died in 1944, aged about 31.

Note: *Note 16.*

Muriel gave birth to one daughter:

Muriel Doreen LLOYD²⁷¹ in 1937

This family is shown as family tree 95.

425. GWENDOLINE DILYS PICKERSGILL [LLOYD] (John's great-great-great-granddaughter) was born in 1914 to Hugh LLOYD⁵⁷³ and Florence LLOYD [HARLEY]⁵⁷⁴, as shown in family tree 138. Gwendoline died in 1998, aged about 84.

426. MR. PICKERSGILL (John's great-great-great-granddaughter's husband). See family tree 96.

Mr. PICKERSGILL married Gwendoline Dilys PICKERSGILL [LLOYD]⁴²⁵. They had one son:

Mr. PICKERSGILL²⁷⁴

This family is shown as family tree 96.

427. KATHLEEN FLORENCE MARTHA TAIT [LLOYD] (John's great-great-great-granddaughter) was born in 1917 to Hugh LLOYD⁵⁷³ and Florence LLOYD [HARLEY]⁵⁷⁴, as shown in family tree 138.

428. MR. TAIT (John's great-great-great-granddaughter's husband). See family tree 97.

Note: *Note 17.*

Mr. TAIT married Kathleen Florence Martha TAIT [LLOYD]⁴²⁷. They had three children:

Jenny TAIT²⁷⁵

Alan TAIT²⁷⁶

Mr. TAIT²⁷⁷

This family is shown as family tree 97.

429. MARGARET MAISIE HARRIS [LLOYD] (John's great-great-great-granddaughter) was born in 1918 to Hugh LLOYD⁵⁷³ and Florence LLOYD [HARLEY]⁵⁷⁴, as shown in family tree 138.

430. MR. HARRIS (John's great-great-great-granddaughter's husband). See family tree 98.

Mr. HARRIS married Margaret Maisie HARRIS [LLOYD]⁴²⁹. They had two sons:

Mr. HARRIS²⁷⁸

Mr. HARRIS²⁷⁹

This family is shown as family tree 98.

431. MERCIA WILLOUGHBY DAVIES [LLOYD] (John's great-great-great-granddaughter) was born in 1921 to Hugh

LLOYD⁵⁷³ and Emily Elizabeth LLOYD [WILLOUGHBY]⁵⁷⁵, as shown in family tree 139. Mercia died in 1982, aged about 61.

432. MR. DAVIES (John's great-great-great-granddaughter's husband). See family tree 99.

Mr. DAVIES married Mercia Willoughby DAVIES [LLOYD]⁴³¹. They had one son:
James DAVIES²⁸⁰ in 1937

This family is shown as family tree 99.

433. HUGH JOHN WILLOUGHBY LLOYD (John's great-great-great-grandson) was born in 1923 to Hugh LLOYD⁵⁷³ and Emily Elizabeth LLOYD [WILLOUGHBY]⁵⁷⁵, as shown in family tree 139. Hugh died in 1923, as an infant.

Note: *Aged 6 weeks (Death).*

434. HERBERT ARTHUR LLOYD - STEPHENS (John's great-great-great-grandson) was born on 25 February 1910, in The Green, Walton, Old Radnor, to Mr. Unknown⁵⁷⁸ and Annie Sophia (aka Nancy) LLOYD⁵⁷⁷, as shown in family tree 140. Herbert died on 23 June 1984, aged 74.

Note: *Note 18.*



435. ALMA LLOYD - STEPHENS [SYMES] (John's great-great-great-grandson's wife) was born in 1910, in Pontypridd. See family tree 100. Alma died in 1994, aged about 84.

Note: *Q4 (Birth).*

Herbert Arthur LLOYD - STEPHENS⁴³⁴, aged about 25, married Alma LLOYD - STEPHENS [SYMES], aged about 25, in 1935 in Pontypridd. They had two sons:

Meic STEPHENS MA Dlott²⁸¹ in 1938

Lloyd STEPHENS²⁸³ in 1943

This family is shown as family tree 100.



436. MURIAL GLADYS LLOYD (John's great-great-great-granddaughter) was born on 6 November 1911 to Mr. Unknown⁵⁷⁸ and Annie Sophia (aka Nancy) LLOYD⁵⁷⁷, as shown in family tree 140. Murial died in 2001, aged about 89.

437. ANNIE MATILDA (NAN) PRITCHETT [EVES] (John's great-great-great-granddaughter) was born on 17 March 1902 to Ernest Edward EVES⁵⁸⁶ and Sophia Matilda (Tillie) EVES [LLOYD]⁵⁸⁵, as shown in family tree 141. Annie died on 25 December 1994, aged 92.

438. AUBREY PRITCHETT (John's great-great-great-granddaughter's husband) was born on 20 August 1904. See family tree 101. Aubrey was a Farmer. Aubrey died on 16 August 2000, aged 95.

Note: *Note 19.*

Aubrey PRITCHETT, aged about 23, married Annie Matilda (Nan) PRITCHETT [EVES]⁴³⁷, aged about 26, in 1928 in Dursley, Gloucestershire. They had one son:

Aubrey E Michael PRITCHETT²⁸⁵

This family is shown as family tree 101.

439. TOM EVAN LANE (John's great-great-great-grandson) was born in 1916 to Thomas LANE⁵⁸⁸ and Elizabeth Anne (Annie) LANE [LLOYD]⁵⁸⁷, as shown in family tree 142.

440. IRENE LANE [BALLINGER] (John's great-great-great-grandson's wife) was born in 1921. See family tree 102.

Tom Evan LANE⁴³⁹ married Irene LANE [BALLINGER]. They had two children:

Philip LANE²⁸⁷ in 1950

Rachel TURNER [LANE]²⁸⁹ in 1953

This family is shown as family tree 102.

441. LAC LAURENCE WALTER HUGH LLOYD RAFVR (John's great-great-great-grandson) was born on 26 December 1921 to Hugh LLOYD⁵⁹² and Laura LLOYD [KINGS]⁵⁹³, as shown in family tree 143. Laurence was a RAFVR.

Laurence died on 20 April 1941, aged 19, in Canada. He was buried in Brandon Cemetery, Manitoba, Canada12.

Note: *Note 20.*



442. DOREEN GLADYS LLOYD (John's great-great-great-granddaughter) was born on 25 April 1924 to Hugh LLOYD⁵⁹² and Laura LLOYD [KINGS]⁵⁹³, as shown in family tree 143.



443. JOHN LLOYD (John's great-great-great-grandson) was born on 12 June 1926, in Fownhope, Herefordshire, to Hugh LLOYD⁵⁹² and Laura LLOYD [KINGS]⁵⁹³, as shown in family tree 143. He was christened in Fownhope Baptist Chapel. He was educated (Cheltenham GS, Loughborough College, William Temple College). He was a Teacher. John died on 17 January 1997, aged 70, in Market Harborough. He was buried on 27 January 1997 in Kibworth Cemetry, Leicestershire.



The following information is also recorded for John. Religion: Baptist.
Note: *Note 21.*

444. BERYL KATHRYN LLOYD [MILLER] (John's great-great-great-grandson's wife) was born on 17 August 1931, in Earls Barton, to Alexander MILLER and Millicent Alice MILLER [SMART]. See family tree 103. Beryl was educated (County High School, Wellingboro; Avery Hill College, Lon SE9). She became a Teacher.
The following information is also recorded for Beryl. Religion: Baptist.
Note: *Note 22.*

John LLOYD⁴⁴³, aged 27, married Beryl Kathryn LLOYD [MILLER], aged 21, on 30 July 1953 in Earls Barton Baptist Church. They had three sons:

David Philip John LLOYD CEng, CITP, MBCS., MAPM²⁹¹ in 1959
Peter Geoffrey LLOYD²⁹³ in 1962
Andrew Robert LLOYD RAF²⁹⁵ in 1967

The following information is also recorded for this family. Family Address, at John & Beryl Katherine Lloyd, 22 Marsh Drive, Kibworth Harcourt, Leicester LE8 ONT.
This family is shown as family tree 103.

445. LAURA MARJORIE SINCLAIR [LLOYD] (John's great-great-great-granddaughter) was born on 27 June 1928 to Hugh LLOYD⁵⁹² and Laura LLOYD [KINGS]⁵⁹³, as shown in family tree 143.

446. DR JACK SINCLAIR (John's great-great-great-granddaughter's husband) was born on 14 September 1914. Jack died on 15 January 2004, aged 89, in Leeds.



Note: *After a long illness (Death).*

Jack SINCLAIR, aged 55, married Laura Marjorie SINCLAIR [LLOYD]⁴⁴⁵, aged 41, in January 1970.

447. ANNIE MABEL (NANCY) BOWS [LLOYD] BA (John's great-great-great-granddaughter) was born on 16 April 1931, in Westbury on Severn, to Hugh LLOYD⁵⁹² and Laura LLOYD [KINGS]⁵⁹³, as shown in family tree 143.

448. RAYMOND GEORGE (BILL) BOWS BA (John's great-great-great-granddaughter's husband) was born on 17 June 1927, in Lincoln. See family tree 104.



Raymond George (Bill) BOWS BA, aged 27, married Annie Mabel (Nancy) BOWS [LLOYD] BA⁴⁴⁷, aged 23, on 4 September 1954. They had three children:

Kathryn Ann LEWIS [BOWS] BMedSci, BM, BS²⁹⁷ in 1956
Richard BOWS RAF (Retd)²⁹⁹ in 1959
Charles Edward Lloyd BOWS MA³⁰¹ in 1967

This family is shown as family tree 104.

449. DAVID KINGSLEY LLOYD (John's great-great-great-grandson) was born on 3 July 1934 to Hugh LLOYD⁵⁹² and Laura LLOYD [KINGS]⁵⁹³, as shown in family tree 143. David became a Teacher Retired Early To Be A Small Farmer In Pembrokeshire.

450. SUSAN M LLOYD [MURRAY] (John's great-great-great-grandson's wife). See family tree 105.

David Kingsley LLOYD⁴⁴⁹, aged 50, married Susan M LLOYD [MURRAY] in March 1985 in Northampton, UK.
They had three children:

Hugh David LLOYD³⁰² in 1986
Jacob Kingsley LLOYD³⁰³ in 1988
Bethan Laura LLOYD³⁰⁴ in 1990

This family is shown as family tree 105.

451. CHRISTINE MEGAN LLOYD (John's great-great-great-granddaughter) was born on 26 March 1937 to Hugh LLOYD⁵⁹² and Laura LLOYD [KINGS]⁵⁹³, as shown in family tree 143.

452. KATHLEEN HARDWICK [LLOYD] (John's great-great-great-granddaughter) was born to Thomas John LLOYD⁵⁹⁴ and Catherine LLOYD [JONES]⁵⁹⁵, as shown in family tree 144.

453. TOM HARDWICK (John's great-great-great-granddaughter's husband). See family tree 106. Tom became a Farmer.

Tom HARDWICK married Kathleen HARDWICK [LLOYD]⁴⁵². They had one son:

David HARDWICK³⁰⁵

This family is shown as family tree 106.

454. SIDNEY WALTER GORDON LLOYD (John's great-great-great-grandson) was born on 1 September 1928, in Cardiff, to Evan Sidney LLOYD⁵⁹⁶ and Mabel LLOYD [KINGS]⁵⁹⁷, as shown in family tree 145. Sidney was educated (Cardiff, Kington Grammar School, St Paul's College Cheltenham). He was a Teacher (Cardiff - Dec 1948, Leominster - July 1987). Sidney died on 18 October 2002, aged 74, in Leominster, UK.
Note: *Note 23.*



455. PEGGY LLOYD [SIMMONS] (John's great-great-great-grandson's wife) was born on 25 February 1930, in Charlton Kings. See family tree 107.
Sidney Walter Gordon LLOYD⁴⁵⁴, aged 22, married Peggy LLOYD [SIMMONS], aged 21, on 24 March 1951 in Charlton Kings Baptist Church. They had three children:
Stephen Gareth LLOYD BSc, D.C³⁰⁶ in 1953
Peter Adrian LLOYD³⁰⁸ in 1956
Heather Joy LLOYD³¹⁰ in 1959
This family is shown as family tree 107.
Note: *By Rev Hugh Lloyd (Marriage).*

456. DILYS LLOYD (John's great-great-great-granddaughter) was born in 1932, in Cardiff, to Evan Sidney LLOYD⁵⁹⁶ and Mabel LLOYD [KINGS]⁵⁹⁷, as shown in family tree 145. Dilys was educated (Howell's School Llandaff). She became an Inland Revenue, Tax Officer Higher Grade 1948 - 1988.

457. JOHN ARTHUR STRATTON (John's great-great-great-grandson) was born on 7 January 1920 to Arthur STRATTON⁵⁹⁹ and Sarah Janet STRATTON [LLOYD]⁵⁹⁸, as shown in family tree 146. John was a Civil Service (Customs & Excise). John died in 1993, aged about 73.

458. HANNAH HESLOP STRATTON [MACAULAY] (John's great-great-great-grandson's wife) was born on 6 April 1917. See family tree 108.
John Arthur STRATTON⁴⁵⁷, aged about 24, married Hannah Heslop STRATTON [MACAULAY], aged about 27, in 1944 in Wandsworth. They had two daughters:
Christine Elizabeth MENEHICK [STRATTON]³¹¹ in 1946
Bronwen Dorothy STRATTON³¹³ in 1948
This family is shown as family tree 108.
Note: *Q1 (Marriage).*

459. EDITH MEGAN ROBERTS [STRATTON] (John's great-great-great-granddaughter) was born on 5 January 1921 to Arthur STRATTON⁵⁹⁹ and Sarah Janet STRATTON [LLOYD]⁵⁹⁸, as shown in family tree 146. Edith died in 1978, aged about 57.

460. ROBERT OWEN ROBERTS (John's great-great-great-granddaughter's husband) was born on 20 December 1917. See family tree 109. Robert was a Professor Of Economics At Swansea University. Robert died in May 2003, aged 85.
Robert Owen ROBERTS married Edith Megan ROBERTS [STRATTON]⁴⁵⁹. They had two daughters:
Gwenllian KNIGHTON [ROBERTS]³¹⁶ in 1950
Janet LEWIS [ROBERTS-LEWIS]³¹⁸ in 1955
This family is shown as family tree 109.

461. EDWARD (EDDIE) PUGH (John's great-great-great-grandson) was born in 1929, in Hay, Brecknockshire, to David PUGH⁶¹⁴ and Eva PUGH [GRIFFITHS]⁶¹³, as shown in family tree 147.

462. JOYCE MARGARET DAVIES [PUGH] (John's great-great-great-granddaughter) was born in 1931, in Hay, Brecknockshire, to David PUGH⁶¹⁴ and Eva PUGH [GRIFFITHS]⁶¹³, as shown in family tree 147.

463. MR. DAVIES (John's great-great-great-granddaughter's husband).
Mr. DAVIES married Joyce Margaret DAVIES [PUGH]⁴⁶².

464. BETTY JAMES [PUGH] (John's great-great-great-granddaughter) was born to David PUGH⁶¹⁴ and Eva PUGH [GRIFFITHS]⁶¹³, as shown in family tree 147.

465. MR. JAMES (John's great-great-great-granddaughter's husband).
Mr. JAMES married Betty JAMES [PUGH]⁴⁶⁴.

466. MARGARET PUGH (John's great-great-great-granddaughter) was born to David PUGH⁶¹⁴ and Eva PUGH [GRIFFITHS]⁶¹³, as shown in family tree 147.
Note: *Note 24.*

467. RUTH POWELL [PUGH] (John's great-great-great-granddaughter) was born to David PUGH⁶¹⁴ and Eva PUGH [GRIFFITHS]⁶¹³, as shown in family tree 147.

468. MR. POWELL (John's great-great-great-granddaughter's husband).
Mr. POWELL married Ruth POWELL [PUGH]⁴⁶⁷.

469. BARBARA PUGH (John's great-great-great-granddaughter) was born to David PUGH⁶¹⁴ and Eva PUGH [GRIFFITHS]⁶¹³, as shown in family tree 147.
Note: *Note 25.*
470. LESLEY M BASTIN [GRIFFITHS] (John's great-great-great-granddaughter) was born in 1928, in Hay, Brecknockshire, to Thomas Clement J GRIFFITHS⁶¹⁵ and Blanche PEVERILL⁶¹⁶, as shown in family tree 148.
471. MR. BASTIN (John's great-great-great-granddaughter's husband).
Mr. BASTIN married Lesley M BASTIN [GRIFFITHS]⁴⁷⁰.
472. PETER GRIFFITHS (John's great-great-great-grandson) was born in 1929, in Hay, Brecknockshire, to Thomas Clement J GRIFFITHS⁶¹⁵ and Blanche PEVERILL⁶¹⁶, as shown in family tree 148.
473. MARJORIE SALLY SMITHERS [GRIFFITHS] (John's great-great-great-granddaughter) was born in 1931, in Hay, Brecknockshire, to Thomas Clement J GRIFFITHS⁶¹⁵ and Blanche PEVERILL⁶¹⁶, as shown in family tree 148.
Note: *Q2 (Birth).*
474. MR. SMITHERS (John's great-great-great-granddaughter's husband).
Mr. SMITHERS married Marjorie Sally SMITHERS [GRIFFITHS]⁴⁷³.
475. PAMELA M GRIFFOTHS [GRIFFITHS] (John's great-great-great-granddaughter) was born in 1932, in Hay, Brecknockshire, to Thomas Clement J GRIFFITHS⁶¹⁵ and Blanche PEVERILL⁶¹⁶, as shown in family tree 148.
Note: *Q2 (Birth).*
476. MR. GRIFFOTHS (John's great-great-great-granddaughter's husband).
Mr. GRIFFOTHS married Pamela M GRIFFOTHS [GRIFFITHS]⁴⁷⁵.
477. PAMELA LEWIS [GRIFFITHS] (John's great-great-great-granddaughter) was born in 1942 to Arthur GRIFFITHS⁶¹⁷ and Maud GRIFFITHS [EVANS]⁶¹⁸, as shown in family tree 149.
478. JOHN LEWIS (John's great-great-great-granddaughter's husband).
John LEWIS married Pamela LEWIS [GRIFFITHS]⁴⁷⁷.
479. MARY WHITTALL (John's great-great-great-granddaughter) was born to Ivor WHITTALL⁶²² and Gwendoline Gertrude WHITTALL [LLOYD]⁶²¹, as shown in family tree 150.
- 
480. JOHN WHITTALL (John's great-great-great-grandson) was born to Ivor WHITTALL⁶²² and Gwendoline Gertrude WHITTALL [LLOYD]⁶²¹, as shown in family tree 150.
Note: *Note 26.*
481. LYNN WHITTALL [FITZPATRICK] (John's great-great-great-grandson's wife).
John WHITTALL⁴⁸⁰ married Lynn WHITTALL [FITZPATRICK] in 1991.
482. KATHLEEN MARY POWELL (John's great-great-great-granddaughter) was born in 1924 to Thomas John POWELL⁶²⁴ and Jane Sophia POWELL [LLOYD]⁶²³, as shown in family tree 151. Kathleen died in 1924, as an infant.
483. DOROTHY MAY JONES [POWELL] (John's great-great-great-granddaughter) was born in 1925 to Thomas John POWELL⁶²⁴ and Jane Sophia POWELL [LLOYD]⁶²³, as shown in family tree 151.
484. HAROLD HENRY JONES (John's great-great-great-granddaughter's husband). See family tree 110.
Harold Henry JONES married Dorothy May JONES [POWELL]⁴⁸³. They had three children:
John JONES³²⁰
Robert JONES³²²
Ann BLANDFORD [JONES]³²⁴
This family is shown as family tree 110.
485. GWENDOLINE JANE (BABS) INGRAM [POWELL] (John's great-great-great-granddaughter) was born in 1926 to Thomas John POWELL⁶²⁴ and Jane Sophia POWELL [LLOYD]⁶²³, as shown in family tree 151.
486. GEORGE JAMES INGRAM (John's great-great-great-granddaughter's husband). See family tree 111.
George James INGRAM married Gwendoline Jane (Babs) INGRAM [POWELL]⁴⁸⁵. They had one daughter:
Jenny INGRAM³²⁶ in 1960
This family is shown as family tree 111.
487. THOMAS JOHN POWELL (John's great-great-great-grandson) was born in 1928 to Thomas John POWELL⁶²⁴ and Jane Sophia POWELL [LLOYD]⁶²³, as shown in family tree 151.

488. ENID POWELL [GORE] (John's great-great-great-grandson's wife). See family tree 112.
 Thomas John POWELL⁴⁸⁷ married Enid POWELL [GORE]. They had three sons:
 John POWELL³²⁷
 Philip POWELL³²⁸ in 1965
 Graham POWELL³²⁹ in 1972
This family is shown as family tree 112.
489. ELIZABETH RACHEL PRICE [POWELL] (John's great-great-great-granddaughter) was born in 1931 to Thomas John POWELL⁶²⁴ and Jane Sophia POWELL [LLOYD]⁶²³, as shown in family tree 151.
490. WILLIAM MERVYN PRICE (John's great-great-great-granddaughter's husband). See family tree 113.
 William Mervyn PRICE married Elizabeth Rachel PRICE [POWELL]⁴⁸⁹. They had three children:
 Lynda PRICE³³⁰ in 1962
 David PRICE³³¹ in 1966
 M PRICE³³² in 1971
This family is shown as family tree 113.
491. KENNETH CHARLES POWELL (John's great-great-great-grandson) was born in 1933 to Thomas John POWELL⁶²⁴ and Jane Sophia POWELL [LLOYD]⁶²³, as shown in family tree 151.
492. RUTH POWELL [PUGH] (John's great-great-great-grandson's wife). See family tree 114.
 Kenneth Charles POWELL⁴⁹¹ married Ruth POWELL [PUGH]. They had two children:
 Margaret POWELL³³³ in 1968
 Andrew POWELL³³⁴ in 1970
This family is shown as family tree 114.
493. EDITH MARGARET DAVIES [POWELL] (John's great-great-great-granddaughter) was born in 1935 to Thomas John POWELL⁶²⁴ and Jane Sophia POWELL [LLOYD]⁶²³, as shown in family tree 151.
494. JEFFREY DAVIES (John's great-great-great-granddaughter's husband). See family tree 115.
 Jeffrey DAVIES married Edith Margaret DAVIES [POWELL]⁴⁹³. They had two sons:
 Richard DAVIES³³⁵
 Roderick DAVIES³³⁶
This family is shown as family tree 115.
495. LENA MARY POWELL (John's great-great-great-granddaughter) was born in 1932, in Kington, to William Baden POWELL⁶²⁶ and Edith Mary POWELL [LLOYD]⁶²⁵, as shown in family tree 152.
 Note: *Q1 (Birth).*
496. EITHEL PUGH POWELL (John's great-great-great-granddaughter's husband). See family tree 116.
 Eithel Pugh POWELL married Lena Mary POWELL⁴⁹⁵, aged about 26, in 1958 in Kington. They had three children:
 Christopher POWELL³³⁷
 Lynette POWELL³³⁸
 Lorraine POWELL³³⁹
This family is shown as family tree 116.
497. JEANETTE BOWEN [POWELL] (John's great-great-great-granddaughter) was born in 1933 to William Baden POWELL⁶²⁶ and Edith Mary POWELL [LLOYD]⁶²⁵, as shown in family tree 152.
498. GILBERT SAMUEL BOWEN (John's great-great-great-granddaughter's husband). See family tree 117.
 Gilbert Samuel BOWEN married Jeanette BOWEN [POWELL]⁴⁹⁷. They had two children:
 Roger BOWEN³⁴⁰
 Clive BOWEN³⁴¹
This family is shown as family tree 117.
499. WILLIAM OWEN POWELL (John's great-great-great-grandson) was born in 1934 to William Baden POWELL⁶²⁶ and Edith Mary POWELL [LLOYD]⁶²⁵, as shown in family tree 152.
500. MARY POWELL [LLOYD] (John's great-great-great-grandson's wife). See family tree 118.
 William Owen POWELL⁴⁹⁹ married Mary POWELL [LLOYD]. They had two children:
 Steven BADEN POWELL³⁴²
 Rebecca BADEN POWELL³⁴³
This family is shown as family tree 118.
501. ROBERT LLOYD POWELL (John's great-great-great-grandson) was born in 1938 to William Baden POWELL⁶²⁶ and Edith Mary POWELL [LLOYD]⁶²⁵, as shown in family tree 152.
502. CHRISTINE POWELL [LEWIS] (John's great-great-great-grandson's wife). See family tree 119.
 Robert Lloyd POWELL⁵⁰¹ married Christine POWELL [LEWIS]. They had three daughters:
 Jane HARRISON [POWELL]³⁴⁴
 Clare TUFT [POWELL]³⁴⁶
 Anna POWELL³⁴⁸
This family is shown as family tree 119.

503. MS. ILES [POWELL] (John's great-great-great-granddaughter) was born in 1940 to William Baden POWELL⁶²⁶ and Edith Mary POWELL [LLOYD]⁶²⁵, as shown in family tree 152.
504. DEREK ILES (John's great-great-great-granddaughter's husband). See family tree 120.
Note: *Note 27*.
Derek ILES married Ms. ILES [POWELL]⁵⁰³. They had two daughters:
Judith ILES³⁴⁹
Lois ILES³⁵⁰
This family is shown as family tree 120.
505. ALBERT JAMES (John's great-great-great-grandson) was born to Henry (Harold) JAMES⁶²⁸ and Sarah Jane (Janey) JAMES [LLOYD]⁶²⁷, as shown in family tree 153.
506. PHYLLIS WILLIAMS [JAMES] (John's great-great-great-granddaughter) was born in 1910 to Henry (Harold) JAMES⁶²⁸ and Sarah Jane (Janey) JAMES [LLOYD]⁶²⁷, as shown in family tree 153. Phyllis died in 1984, aged about 74.
507. SID WILLIAMS (John's great-great-great-granddaughter's husband). See family tree 121.
Sid WILLIAMS married Phyllis WILLIAMS [JAMES]⁵⁰⁶, aged about 25, in 1935. They had two sons:
Kenneth (Ken) WILLIAMS³⁵¹
Glyn WILLIAMS³⁵³ in 1945
This family is shown as family tree 121.
508. MARY JAMES (John's great-great-great-granddaughter) was born in 1915 to Henry (Harold) JAMES⁶²⁸ and Sarah Jane (Janey) JAMES [LLOYD]⁶²⁷, as shown in family tree 153. Mary died in 2007, aged about 92.
Mary married twice. She was married to Mr. Unknown⁵⁰⁹ and David LEWIS⁵¹⁰.
Note: *Note 28*.
509. MR. UNKNOWN (John's great-great-great-granddaughter's husband). See family tree 122.
Note: *Note 29*.
Mr. Unknown married Mary JAMES⁵⁰⁸. They had one daughter:
Rita Hazel FARMER [JAMES]³⁵⁵ in 1932
This family is shown as family tree 122.
510. DAVID LEWIS (John's great-great-great-granddaughter's husband). See family tree 123.
David LEWIS married Mary JAMES⁵⁰⁸. They had two children:
Gwyndaf LEWIS³⁵⁷
Carol LEWIS³⁵⁸
This family is shown as family tree 123.
511. DENNIS JAMES (John's great-great-great-grandson) was born to Henry (Harold) JAMES⁶²⁸ and Sarah Jane (Janey) JAMES [LLOYD]⁶²⁷, as shown in family tree 153.
512. MARGEURITE J MORGAN [JAMES] (John's great-great-great-granddaughter) was born in 1921, in Kington, to Henry (Harold) JAMES⁶²⁸ and Sarah Jane (Janey) JAMES [LLOYD]⁶²⁷, as shown in family tree 153. Margeurite died in 1966, aged about 45.
Note: *Q1 (Birth)*.
513. THOMAS A MORGAN (John's great-great-great-granddaughter's husband). See family tree 124.
Thomas A MORGAN married Margeurite J MORGAN [JAMES]⁵¹², aged about 19, in 1940 in Kington. They had two sons:
Austin Thomas James MORGAN³⁵⁹ in 1941
Winston Barrie MORGAN³⁶⁰ in 1951
This family is shown as family tree 124.
Note: *Q4 (Marriage)*.
514. VINCENT LLOYD (John's great-great-great-grandson) was born in 1912 to Thomas LLOYD⁶³¹ and Margaret Jane LLOYD [PRITCHARD]⁶³², as shown in family tree 154.
515. WALTER LLOYD (John's great-great-great-grandson) was born in 1913 to Thomas LLOYD⁶³¹ and Margaret Jane LLOYD [PRITCHARD]⁶³², as shown in family tree 154.
516. DOROTHY CLARE LLOYD [DAVIES] (John's great-great-great-grandson's wife) was born in 1905. See family tree 125.
Dorothy died in 1955, aged about 50.
Walter LLOYD⁵¹⁵ married Dorothy Clare LLOYD [DAVIES]. They had two daughters:
Peggy LLOYD³⁶² in 1942
Carmen LLOYD³⁶³ in 1944
This family is shown as family tree 125.
517. JAMES HAMER LLOYD (John's great-great-great-grandson) was born to James LLOYD⁶³⁵ and Sarah Ann LLOYD [HAMER]⁶³⁶, as shown in family tree 155.

518. NORAH LLOYD (John's great-great-great-grandson's wife).
James Hamer LLOYD⁵¹⁷ married Norah LLOYD.
519. EMILY MAUD DUGGAN [LLOYD] (John's great-great-great-granddaughter) was born to James LLOYD⁶³⁵ and Sarah Ann LLOYD [HAMER]⁶³⁶, as shown in family tree 155.
520. JOHN (JACK) E DUGGAN (John's great-great-great-granddaughter's husband) was born in 1917, in Kington. See family tree 126.
Note: *Q2 (Birth)*.
John (Jack) E DUGGAN, aged about 38, married Emily Maud DUGGAN [LLOYD]⁵¹⁹ in 1955. They had two children:
John DUGGAN³⁶⁴
Jean DUGGAN³⁶⁵
This family is shown as family tree 126.
521. EVAN RICE LLOYD (John's great-great-great-grandson) was born on 30 July 1921 to James LLOYD⁶³⁵ and Sarah Ann LLOYD [HAMER]⁶³⁶, as shown in family tree 155. Evan died in 1989, aged about 67.
522. HILDA LLOYD (John's great-great-great-grandson's wife) was born on 2 July 1924. See family tree 127.
Evan Rice LLOYD⁵²¹ married Hilda LLOYD. They had two children:
Elizabeth Anne NEWTON [LLOYD]³⁶⁶ in 1952
David Evan LLOYD³⁶⁸ in 1954
This family is shown as family tree 127.
523. HENRY CHARLES LLOYD (John's great-great-great-grandson) was born in 1923 to James LLOYD⁶³⁵ and Sarah Ann LLOYD [HAMER]⁶³⁶, as shown in family tree 155. Henry died in 1999, aged about 76.
524. ENID A LLOYD [BAKER] (John's great-great-great-grandson's wife). See family tree 128.
Henry Charles LLOYD⁵²³, aged about 32, married Enid A LLOYD [BAKER] in 1955. They had two sons:
Robert LLOYD³⁷⁰
Graham C LLOYD³⁷¹
This family is shown as family tree 128.
525. JOAN POWELL [LLOYD] (John's great-great-great-granddaughter) was born to James LLOYD⁶³⁵ and Sarah Ann LLOYD [HAMER]⁶³⁶, as shown in family tree 155.
526. DAVID POWELL (John's great-great-great-granddaughter's husband). See family tree 129.
David POWELL married Joan POWELL [LLOYD]⁵²⁵. They had two daughters:
Anita Jane SKYRME [POWELL]³⁷³ in 1963
Kathryn Ann WILLIAMS [POWELL]³⁷⁵ in 1966
This family is shown as family tree 129.
527. ETHEL ELIZABETH LLOYD (John's great-great-great-granddaughter) was born in 1917, in Knighton, to Charles LLOYD⁶³⁷ and Lily May (aka Doris) LLOYD [EVANS]⁶³⁸, as shown in family tree 156. Ethel died on 27 May 2004, aged about 86.
528. CHARLES G LLOYD (John's great-great-great-grandson) was born in 1918, in Knighton, to Charles LLOYD⁶³⁷ and Lily May (aka Doris) LLOYD [EVANS]⁶³⁸, as shown in family tree 156.
529. EDWARD (TED) A LLOYD (John's great-great-great-grandson) was born in 1921, in Knighton, to Charles LLOYD⁶³⁷ and Lily May (aka Doris) LLOYD [EVANS]⁶³⁸, as shown in family tree 156.
530. HILDE LLOYD (John's great-great-great-granddaughter) was born in 1924, in Knighton, to Charles LLOYD⁶³⁷ and Lily May (aka Doris) LLOYD [EVANS]⁶³⁸, as shown in family tree 156.
531. DOROTHY MARY LLOYD (John's great-great-great-granddaughter) was born in 1930, in Knighton, to Charles LLOYD⁶³⁷ and Lily May (aka Doris) LLOYD [EVANS]⁶³⁸, as shown in family tree 156. Dorothy died on 6 April 2005, aged about 74.
532. MARIAN JANE LLOYD (John's great-great-great-granddaughter) was born in 1934, in Knighton, to Charles LLOYD⁶³⁷ and Lily May (aka Doris) LLOYD [EVANS]⁶³⁸, as shown in family tree 156.
533. GRAHAM HUGH LLOYD (John's great-great-great-grandson) was born in 1920 to Hugh LLOYD⁶³⁹ and Frances LLOYD [EDITH]⁶⁴⁰, as shown in family tree 157. Graham died on 7 January 1944, aged about 23. He was buried in Banneville-La-Campagne War Cemetery.
Note: *Note 30.*
534. ROLAND LLOYD (John's great-great-great-grandson) was born in 1926, in Kington, to Danzey Evan LLOYD⁶⁴¹ and Gertrude LLOYD [JONES]⁶⁴², as shown in family tree 158.

Note: *Q2 (Birth)*.

535. MONA LLOYD (John's great-great-great-granddaughter) was born in 1926 to Danzey Evan LLOYD⁶⁴¹ and Gertrude LLOYD [JONES]⁶⁴², as shown in family tree 158. Mona died in 1992, aged about 66.
Note: *Note 31*.
536. ALICE MAY (DIDDY) LLOYD (John's great-great-great-granddaughter) was born in 1930 to Danzey Evan LLOYD⁶⁴¹ and Gertrude LLOYD [JONES]⁶⁴², as shown in family tree 158. Alice died in March 1974, aged about 43, in Cherry Trees, Hay On Wye. She was buried in Rhos Goch.
Note: *Note 32*.
537. GORDON ROGERS UNKNOWN (John's great-great-great-granddaughter's husband).
Gordon Rogers Unknown married Alice May (Diddy) LLOYD⁵³⁶.
538. HUGH LLOYD (John's great-great-great-grandson) was born on 16 May 1918 to Hugh LLOYD⁶⁴⁵ and Susannah LLOYD [GODWIN]⁶⁴⁶, as shown in family tree 159. Hugh died on 7 June 2003, aged 85.
Note: *Note 33*.
- 
539. EVA GRACE LLOYD [MORRIS] (John's great-great-great-grandson's wife) was born on 12 April 1925, in Clehonger. See family tree 130.
Hugh LLOYD⁵³⁸ married Eva Grace LLOYD [MORRIS]. They had two sons:
Alan Hugh LLOYD³⁷⁷ in 1948
Elwyn John LLOYD³⁷⁹ in 1952
This family is shown as family tree 130.
540. DORIS PHILLIPS [LLOYD] (John's great-great-great-granddaughter) was born in September 1924 to Hugh LLOYD⁶⁴⁵ and Susannah LLOYD [GODWIN]⁶⁴⁶, as shown in family tree 159. Doris died in August 1999, aged 74.
541. VICTOR EVAN PHILLIPS (John's great-great-great-granddaughter's husband). See family tree 131.
Note: *Note 34*.
Victor Evan PHILLIPS married Doris PHILLIPS [LLOYD]⁵⁴⁰. They had two sons:
Ian PHILLIPS³⁸¹ in 1951
Colin PHILLIPS³⁸³ in 1954
This family is shown as family tree 131.
542. ELIZABETH NANCY LEWIS [LLOYD] (John's great-great-great-granddaughter) was born in 1931 to Hugh LLOYD⁶⁴⁵ and Susannah LLOYD [GODWIN]⁶⁴⁶, as shown in family tree 159. Elizabeth died in 1960, aged about 29.
543. JOHN LEWIS (John's great-great-great-granddaughter's husband). See family tree 132.
John LEWIS married Elizabeth Nancy LEWIS [LLOYD]⁵⁴², aged about 27, in 1958. They had one son:
John H LEWIS³⁸⁵ in 1959
This family is shown as family tree 132.
544. MARGARET PRICE [LLOYD] (John's great-great-great-granddaughter) was born to James LLOYD⁶⁵¹ and Anne LLOYD [PHILLIPS]⁶⁵², as shown in family tree 160.
545. EDWARD PRICE (John's great-great-great-granddaughter's husband). See family tree 133.
Edward PRICE married Margaret PRICE [LLOYD]⁵⁴⁴. They had three children:
Edward PRICE³⁸⁷ in 1967
Dawn WILLIAMS [PRICE]³⁸⁸ in 1970
Marcus PRICE³⁹⁰ in 1974
This family is shown as family tree 133.
546. MILDRED LLOYD (John's great-great-great-granddaughter) was born in 1914, in Crickhowell, to Thomas Hugh LLOYD⁶⁵⁶ and Eva May LLOYD [CLARKE]⁶⁵⁷, as shown in family tree 161.
Note: *Q1 (Birth)*.
547. ROSA J LLOYD (John's great-great-great-granddaughter) was born in 1916, in Crickhowell, to Thomas Hugh LLOYD⁶⁵⁶ and Eva May LLOYD [CLARKE]⁶⁵⁷, as shown in family tree 161.
Note: *Q3 (Birth)*.
548. ARTHUR E LLOYD (John's great-great-great-grandson) was born in 1922, in Crickhowell, to Thomas Hugh LLOYD⁶⁵⁶ and Beatrice Eva LLOYD [LEWIS]⁶⁵⁸, as shown in family tree 162.
549. HILDA E LLOYD (John's great-great-great-granddaughter) was born in 1924, in Crickhowell, to Thomas Hugh LLOYD⁶⁵⁶ and Beatrice Eva LLOYD [LEWIS]⁶⁵⁸, as shown in family tree 162.

550. EDITH A LLOYD (John's great-great-great-granddaughter) was born in 1926, in Crickhowell, to Thomas Hugh LLOYD⁶⁵⁶ and Beatrice Eva LLOYD [LEWIS]⁶⁵⁸, as shown in family tree 162.

Generation of Great-Great-Grandchildren

551. ELIZABETH ANN (ELIZA) LLOYD [MEREDITH] (John's great-great-granddaughter) was born in 1861, in Glascwm, to Samuel MEREDITH⁶⁶⁹ and Ann MEREDITH [LLOYD]⁶⁶⁸, as shown in family tree 163. Elizabeth resided at Llanshivor, Glascwm 10.

552. BENJAMIN LLOYD (John's great-great-granddaughter's husband) was born in 1861, in Old Radnor. Benjamin was an Agricultural Labourer For Father 10 Of 260 Acres.

Note: *Note 35.*

Benjamin LLOYD married Elizabeth Ann (Eliza) LLOYD [MEREDITH]⁵⁵¹.

553. SAMUEL MEREDITH (John's great-great-grandson) was born in 1865, in Glascwm, to Samuel MEREDITH⁶⁶⁹ and Ann MEREDITH [LLOYD]⁶⁶⁸, as shown in family tree 163.

554. THOMAS MEREDITH (John's great-great-grandson) was born in 1868, in Glascwm, to Samuel MEREDITH⁶⁶⁹ and Ann MEREDITH [LLOYD]⁶⁶⁸, as shown in family tree 163.

Note: *Note 36.*

555. ANNIE GOODWIN [MEREDITH] (John's great-great-granddaughter) was born in 1871, in Glascwm, to Samuel MEREDITH⁶⁶⁹ and Ann MEREDITH [LLOYD]⁶⁶⁸, as shown in family tree 163.

556. MR. GOODWIN (John's great-great-granddaughter's husband).

Mr. GOODWIN married Annie GOODWIN [MEREDITH]⁵⁵⁵.

557. HUGH CALEB LLOYD (John's great-great-grandson) was born in 1865 to Thomas LLOYD⁶⁷⁰ and Margaret LLOYD [CONNOP]⁶⁷¹, as shown in family tree 164. Hugh was a Bonesetter. Hugh died in 1953, aged about 88.



558. JAMES THOMAS (TOM) LLOYD (John's great-great-grandson) was born in 1866, in Eardisley, Hereford, England, to Thomas LLOYD⁶⁷⁰ and Margaret LLOYD [CONNOP]⁶⁷¹, as shown in family tree 164. James was a Bonesetter. James died on 17 December 1934, aged about 68. He was buried in Llangunllo.

Note: *Note 37.*

559. MARGARET DREW [LLOYD] (John's great-great-granddaughter) was born in 1868, in Glascwm, to Thomas LLOYD⁶⁷⁰ and Margaret LLOYD [CONNOP]⁶⁷¹, as shown in family tree 164. Margaret was a Bonesetter. Margaret died on 7 May 1948, aged about 79. She was buried in Lyonshall.

560. EDMUNDD DANZEY DREW (John's great-great-granddaughter's husband) was born in 1866, in Llanwrthwl, Brecknock, Wales. See family tree 134. Edmundd was a Bonesetter. Edmundd died on 9 July 1934, aged about 68. He was buried in Lyonshall.

Note: *Note 38.*

Edmundd Danzey DREW, aged about 30, married Margaret DREW [LLOYD]⁵⁵⁹, aged about 28, in 1896 in Knighton. They had six children:

Edmund DREW³⁹¹ in 1907

Marjorie DREW³⁹²

Gladys DREW³⁹³

Danzey DREW³⁹⁴

Elizabeth Mary DREW³⁹⁵

Minnie Sophia DREW³⁹⁶

This family is shown as family tree 134.

Note: *Q2 (Marriage).*



561. ELIZABETH DAVIES [LLOYD] (John's great-great-granddaughter) was born in 1870, in Glascwm, to Thomas LLOYD⁶⁷⁰ and Margaret LLOYD [CONNOP]⁶⁷¹, as shown in family tree 164.



562. WILLIAM EDWARD DAVIES (John's great-great-granddaughter's husband).

William Edward DAVIES married Elizabeth DAVIES [LLOYD]⁵⁶¹, aged about 37, in 1907 in Knighton.

563. MARY ANN (POLLY) WILLIAMS [LLOYD] (John's great-great-granddaughter) was born in 1872, in Glascwm, to Thomas LLOYD⁶⁷⁰ and Margaret LLOYD [CONNOP]⁶⁷¹, as shown in family tree 164.

564. WILLIAM WILLIAMS (John's great-great-granddaughter's husband). See family tree 135.
William WILLIAMS married Mary Ann (Polly) WILLIAMS [LLOYD]⁵⁶³, aged about 27, in 1899 in Knighton. They had one daughter:
Mary WILLIAMS³⁹⁷ in 1901
This family is shown as family tree 135.
Note: *Q3 (Marriage).*
565. JOHN EVAN LLOYD (John's great-great-grandson) was born in 1876, in Glascwm, to Thomas LLOYD⁶⁷⁰ and Margaret LLOYD [CONNOP]⁶⁷¹, as shown in family tree 164. John died in 1948, aged about 72.
Note: *Note 39.*
566. SARAH ROSA BYWATER [LLOYD] (John's great-great-granddaughter) was born in 1877, in Glascwm, to Thomas LLOYD⁶⁷⁰ and Margaret LLOYD [CONNOP]⁶⁷¹, as shown in family tree 164. Sarah was a Bonesetter. Sarah died in 1929, aged about 52.
567. RICHARD BYWATER (John's great-great-granddaughter's husband) was born in 1872. See family tree 136. Richard died in 1963, aged about 91, in Leominster, UK.
Notes:
• *Q1 (Birth).*
• *Q4 (Death).*
Richard BYWATER, aged about 27, married Sarah Rosa BYWATER [LLOYD]⁵⁶⁶, aged about 22, in 1899 in Knighton. They had ten children:
Richard BYWATER³⁹⁸
Rosa Mary BYWATER⁴⁰¹ in 1902
Caleb James BYWATER⁴⁰² in 1902
Adah Margaret BYWATER⁴⁰⁴ in 1903
John (aka Jack) BYWATER⁴⁰⁵ in 1904
Naomi MORRIS [BYWATER]⁴⁰⁷ in 1907
Thomas BYWATER⁴⁰⁹
Robert David BYWATER⁴¹¹ in 1910
Joyce Sarah HARRIS [BYWATER]⁴¹³ in 1914
Constance Minnie DAVIES [BYWATER]⁴¹⁵ in 1916
This family is shown as family tree 136.
Note: *Q2 (Marriage).*
568. ANN SOPHIA ROBERTS [LLOYD] (John's great-great-granddaughter) was born in 1880, in Glascwm, to Thomas LLOYD⁶⁷⁰ and Margaret LLOYD [CONNOP]⁶⁷¹, as shown in family tree 164. Ann died in 1933, aged about 53.
569. WILLIAM OWEN ROBERTS (John's great-great-granddaughter's husband) was born in 1872. See family tree 137. William died in 1955, aged about 83.
William Owen ROBERTS, aged about 29, married Ann Sophia ROBERTS [LLOYD]⁵⁶⁸, aged about 21, in 1901 in Knighton. They had four children:
William Thomas ROBERTS⁴¹⁷ in 1903
Gladys Anne ROBERTS⁴¹⁹ in 1904
James Albert ROBERTS⁴²⁰ in 1906
William Caleb ROBERTS⁴²² in 1910
This family is shown as family tree 137.
Note: *Q3 (Marriage).*
570. ADA AGNES BYWATER [LLOYD] (John's great-great-granddaughter) was born in 1883, in Glascwm, to Thomas LLOYD⁶⁷⁰ and Margaret LLOYD [CONNOP]⁶⁷¹, as shown in family tree 164. Ada died in 1937, aged about 54.
571. JOHN BYWATER (John's great-great-granddaughter's husband) was born in 1877. John died in 1945, aged about 68.

John BYWATER, aged about 49, married Ada Agnes BYWATER [LLOYD]⁵⁷⁰, aged about 43, in 1926 in Lea Hall.
Note: *Q2 (Marriage).*
572. MINNIE GLADYS LLOYD (John's great-great-granddaughter) was born in 1888, in Glascwm, to Thomas LLOYD⁶⁷⁰ and Margaret LLOYD [CONNOP]⁶⁷¹, as shown in family tree 164. Minnie died in 1963, aged about 75.
573. HUGH LLOYD (John's great-great-grandson) was born in 1888 to Hugh LLOYD⁶⁷³ and Martha LLOYD [POWELL]⁶⁷⁴, as shown in family tree 165. Hugh was a Farmer. Hugh died in July 1968, aged about 80, in Hereford, UK. Hugh married three times. He was married to Florence LLOYD [HARLEY]⁵⁷⁴, Emily Elizabeth LLOYD [WILLOUGHBY]⁵⁷⁵ and Sarah Maude LLOYD [OWEN]⁵⁷⁶.
Note: *Note 40.*

574. FLORENCE LLOYD [HARLEY] (John's great-great-grandson's wife) was born in 1891. See family tree 138. Florence died in 1918, aged about 27.
 Hugh LLOYD⁵⁷³ married Florence LLOYD [HARLEY]. They had four daughters:
 Muriel Annie (Dolly) LLOYD⁴²⁴ in 1913
 Gwendoline Dilys PICKERSGILL [LLOYD]⁴²⁵ in 1914
 Kathleen Florence Martha TAIT [LLOYD]⁴²⁷ in 1917
 Margaret Maisie HARRIS [LLOYD]⁴²⁹ in 1918
This family is shown as family tree 138.
575. EMILY ELIZABETH LLOYD [WILLOUGHBY] (John's great-great-grandson's wife) was born in 1883, in Llandrindod Wells. See family tree 139. Emily died in 1931, aged about 48.
 Hugh LLOYD⁵⁷³ married Emily Elizabeth LLOYD [WILLOUGHBY]. They had two children:
 Mercia Willoughby DAVIES [LLOYD]⁴³¹ in 1921
 Hugh John Willoughby LLOYD⁴³³ in 1923
This family is shown as family tree 139.
576. SARAH MAUDE LLOYD [OWEN] (John's great-great-grandson's wife) was born in 1896. Sarah was a Headmistress At Glascwm School. Sarah died in 1971, aged about 75.
 Hugh LLOYD⁵⁷³, aged about 61, married Sarah Maude LLOYD [OWEN], aged about 53, in 1949.
577. ANNIE SOPHIA (AKA NANCY) LLOYD (John's great-great-granddaughter) was born on 25 February 1890 to Hugh LLOYD⁶⁷³ and Martha LLOYD [POWELL]⁶⁷⁴, as shown in family tree 165. Annie died on 15 April 1971, aged 81. She was buried in Great Harwood, Shrewsbury.
 Annie married twice. She was married to Mr. Unknown⁵⁷⁸ and Alfred Cornelius PASSANT⁵⁷⁹.
 Note: *Note 41.*
- 
578. MR. UNKNOWN (John's great-great-granddaughter's husband). See family tree 140.
 Mr. Unknown married Annie Sophia (aka Nancy) LLOYD⁵⁷⁷ in Unmarried. They had two children:
 Herbert Arthur LLOYD - STEPHENS⁴³⁴ in 1910
 Murial Gladys LLOYD⁴³⁶ in 1911
This family is shown as family tree 140.
579. ALFRED CORNELIUS PASSANT (John's great-great-granddaughter's husband) was born in 1900, in Forden, Montgomeryshire. Alfred died in 1986, aged about 86. He was buried in Great Harwood, Shrewsbury.
 Note: *Note 42.*
 Alfred Cornelius PASSANT, aged about 36, married Annie Sophia (aka Nancy) LLOYD⁵⁷⁷, aged about 46, in 1936.
 Note: *Note 43.*
580. ANNE LLOYD (John's great-great-granddaughter) was born to John LLOYD⁶⁷⁵ and Mary Ann LLOYD [DAVIES]⁶⁷⁶, as shown in family tree 166. She was buried in Kington.
 Notes:
 • *Note 44.*
 • *Was listed at Huntingdon (Burial).*
581. ELIZABETH ANN (LIZZIE) DAVIES [JAMES] (John's great-great-granddaughter) was born in 1872 to James JAMES⁶⁷⁸ and Elizabeth (Bessie) JAMES [LLOYD]⁶⁷⁷, as shown in family tree 167. Elizabeth died on 4 October 1932, aged about 60, in Llandrindod Wells.
582. MR. DAVIES (John's great-great-granddaughter's husband).
 Mr. DAVIES married Elizabeth Ann (Lizzie) DAVIES [JAMES]⁵⁸¹.
583. ADELIZA ANN LLOYD (John's great-great-granddaughter) was born on 22 July 1870, in Llanfihangell, to William LLOYD⁶⁷⁹ and Sarah LLOYD [MILWARD]⁶⁸⁰, as shown in family tree 168. She was christened on 4 August 1870. Adeliza died on 28 December 1938, aged 68. She was buried in Michaelchurch.
 Note: *Note 45.*
- 
584. WILLIAM BAYLEY LLOYD (John's great-great-grandson) was born on 16 October 1871, in Llanfihangell, to William LLOYD⁶⁷⁹ and Sarah LLOYD [MILWARD]⁶⁸⁰, as shown in family tree 168. William died on 19 December 1943, aged 72. He was buried in Michaelchurch.
 Note: *Note 46.*
- 

585. SOPHIA MATILDA (TILLIE) EVES [LLOYD] (John's great-great-granddaughter) was born on 29 November 1872, in Llanfihangel, to William LLOYD⁶⁷⁹ and Sarah LLOYD [MILWARD]⁶⁸⁰, as shown in family tree 168. Sophia died on 21 February 1956, aged 83. She was buried in Michaelchurch.
Note: *Note 47.*
586. ERNEST EDWARD EVES (John's great-great-granddaughter's husband). See family tree 141.
Ernest Edward EVES married Sophia Matilda (Tillie) EVES [LLOYD]⁵⁸⁵, aged about 28, in 1901 in Docking, Norfolk. They had one daughter:
Annie Matilda (Nan) PRITCHETT [EVES]⁴³⁷ in 1902
This family is shown as family tree 141.
587. ELIZABETH ANNE (ANNIE) LANE [LLOYD] (John's great-great-granddaughter) was born on 14 May 1876, in Gladestry, to William LLOYD⁶⁷⁹ and Sarah LLOYD [MILWARD]⁶⁸⁰, as shown in family tree 168. Elizabeth died in 1955, aged about 79.
Note: *Note 48.*
588. THOMAS LANE (John's great-great-granddaughter's husband). See family tree 142.
Thomas LANE married Elizabeth Anne (Annie) LANE [LLOYD]⁵⁸⁷, aged about 38, in 1914 in Cheltenham. They had one son:
Tom Evan LANE⁴³⁹ in 1916
This family is shown as family tree 142.
589. ALICE LLOYD (John's great-great-granddaughter) was born on 2 May 1878, in Gladestry, to William LLOYD⁶⁷⁹ and Sarah LLOYD [MILWARD]⁶⁸⁰, as shown in family tree 168. Alice died on 29 September 1948, aged 70. She was buried in Michaelchurch.
Note: *Note 49.*
590. CHARLES LLOYD (John's great-great-grandson) was born in 1880, in Gladestry, to William LLOYD⁶⁷⁹ and Sarah LLOYD [MILWARD]⁶⁸⁰, as shown in family tree 168. Charles died on 10 November 1893, aged about 13. He was buried in Michaelchurch.
Note: *Note 50.*
591. GLADYS LLOYD (John's great-great-granddaughter) was born on 2 September 1881 to William LLOYD⁶⁷⁹ and Sarah LLOYD [MILWARD]⁶⁸⁰, as shown in family tree 168. Gladys died on 24 February 1961, aged 79.
592. HUGH LLOYD (John's great-great-grandson) was born in October 1883, in Huntington, UK, to William LLOYD⁶⁷⁹ and Sarah LLOYD [MILWARD]⁶⁸⁰, as shown in family tree 168. He was christened in Haverfordwest. He was a Minister. Hugh died on 21 December 1963, aged 80, in Harpole, Northamptonshire.
The following information is also recorded for Hugh. Religion: Baptist.
Note: *Note 51.*
- 
593. LAURA LLOYD [KINGS] (John's great-great-grandson's wife) was born on 13 September 1897. See family tree 143.
Laura died in 1986, aged about 88, in Harpole, Northamptonshire.
Hugh LLOYD⁵⁹², aged 37, married Laura LLOYD [KINGS], aged 23, on 29 March 1921 in Catshill, Worcestershire. They had seven children:
Laurence Walter Hugh LLOYD RAFVR⁴⁴¹ in 1921
Doreen Gladys LLOYD⁴⁴² in 1924
John LLOYD⁴⁴³ in 1926
Laura Marjorie SINCLAIR [LLOYD]⁴⁴⁵ in 1928
Annie Mabel (Nancy) BOWS [LLOYD] BA⁴⁴⁷ in 1931
David Kingsley LLOYD⁴⁴⁹ in 1934
Christine Megan LLOYD⁴⁵¹ in 1937
This family is shown as family tree 143.
594. THOMAS JOHN LLOYD (John's great-great-grandson) was born on 8 November 1885 to William LLOYD⁶⁷⁹ and Sarah LLOYD [MILWARD]⁶⁸⁰, as shown in family tree 168. Thomas was a Blacksmith. Thomas died in 1954, aged about 68. He was buried in Newchurch.
Note: *Note 52.*
- 
595. CATHERINE LLOYD [JONES] (John's great-great-grandson's wife). See family tree 144.
Thomas John LLOYD⁵⁹⁴, aged about 30, married Catherine LLOYD [JONES] in 1916 in Swansea. They had one daughter:
Kathleen HARDWICK [LLOYD]⁴⁵²
This family is shown as family tree 144.

Note: Q4 (Marriage).

596. EVAN SIDNEY LLOYD (John's great-great-grandson) was born on 8 April 1887 to William LLOYD⁶⁷⁹ and Sarah LLOYD [MILWARD]⁶⁸⁰, as shown in family tree 168. Evan was a Grocer's Manager. Evan died on 31 March 1941, aged 53, in Cardiff.



Note: Note 53.

597. MABEL LLOYD [KINGS] (John's great-great-grandson's wife) was born on 26 January 1893. See family tree 145. Mabel died on 12 May 1993, aged 100.

Note: Note 54.

Evan Sidney LLOYD⁵⁹⁶, aged 39, married Mabel LLOYD [KINGS], aged 33, on 25 May 1926 in Catshill, Worcestershire. They had two children:

Sidney Walter Gordon LLOYD⁴⁵⁴ in 1928

Dilys LLOYD⁴⁵⁶ in 1932

This family is shown as family tree 145.

598. SARAH JANET STRATTON [LLOYD] (John's great-great-granddaughter) was born on 18 July 1890 to William LLOYD⁶⁷⁹ and Sarah LLOYD [MILWARD]⁶⁸⁰, as shown in family tree 168. Sarah died on 24 September 1989, aged 99.
Note: Note 55.

599. ARTHUR STRATTON (John's great-great-granddaughter's husband) was born on 9 July 1890. See family tree 146. Arthur died on 12 April 1940, aged 49.

Arthur STRATTON, aged about 27, married Sarah Janet STRATTON [LLOYD]⁵⁹⁸, aged about 27, in 1918 in West Bromwich. They had two children:

John Arthur STRATTON⁴⁵⁷ in 1920

Edith Megan ROBERTS [STRATTON]⁴⁵⁹ in 1921

This family is shown as family tree 146.

600. EDITH LLOYD (John's great-great-granddaughter) was born in October 1893 to William LLOYD⁶⁷⁹ and Sarah LLOYD [MILWARD]⁶⁸⁰, as shown in family tree 168. Edith died on 26 March 1894, aged 5 months. She was buried in Michaelchurch.

601. DR EVAN THOMAS LLOYD FRSM, MBMA, MRSI (John's great-great-grandson) was born on 31 October 1887, in Empton Farm, UK, to Evan LLOYD⁶⁸¹ and Clara LLOYD [HILL]⁶⁸², as shown in family tree 169. Evan was an Orthopaedic Surgeon. Evan died on 22 December 1958, aged 71, in Empton Farm, UK. He was buried in Kington.



Note: Note 56.

602. ELIZABETH FLORENCE LLOYD (John's great-great-granddaughter) was born in 1890 to Evan LLOYD⁶⁸¹ and Clara LLOYD [HILL]⁶⁸², as shown in family tree 169. Elizabeth died in 1966, aged about 76.

Note: Note 57.

603. ANNIE CLARA LLOYD (John's great-great-granddaughter) was born in 1896 to Evan LLOYD⁶⁸¹ and Clara LLOYD [HILL]⁶⁸², as shown in family tree 169. Annie died in 1971, aged about 75.

Note: Note 58.

604. ADA MARION GITTOES [LLOYD] (John's great-great-granddaughter) was born in 1901 to Evan LLOYD⁶⁸¹ and Clara LLOYD [HILL]⁶⁸², as shown in family tree 169. Ada died in 1966, aged about 65.

605. JAMES GITTOES (John's great-great-granddaughter's husband).

James GITTOES married Ada Marion GITTOES [LLOYD]⁶⁰⁴.

606. SARAH ANNE MORGAN (John's great-great-granddaughter) was born in 1879, in Bryngwyn, Radnorshire, UK, to William MORGAN⁶⁸⁴ and Sarah Sophia MORGAN [LLOYD]⁶⁸³, as shown in family tree 170.

607. MARY ELIZABETH WILLIAMS [MORGAN] (John's great-great-granddaughter) was born in 1880, in Bryngwyn, Radnorshire, UK, to William MORGAN⁶⁸⁴ and Sarah Sophia MORGAN [LLOYD]⁶⁸³, as shown in family tree 170.

608. MR. WILLIAMS (John's great-great-granddaughter's husband).

Mr. WILLIAMS married Mary Elizabeth WILLIAMS [MORGAN]⁶⁰⁷.

609. WILLIAM THOMAS MORGAN (John's great-great-grandson) was born in 1883, in Bryngwyn, Radnorshire, UK, to William MORGAN⁶⁸⁴ and Sarah Sophia MORGAN [LLOYD]⁶⁸³, as shown in family tree 170.

610. EVAN JOHN LLOYD MORGAN (John's great-great-grandson) was born in 1885, in Clyro, Radnorshire, UK, to William MORGAN⁶⁸⁴ and Sarah Sophia MORGAN [LLOYD]⁶⁸³, as shown in family tree 170.
611. EDWARD G MORGAN (John's great-great-grandson) was born in 1891, in Clyro, Radnorshire, UK, to William MORGAN⁶⁸⁴ and Sarah Sophia MORGAN [LLOYD]⁶⁸³, as shown in family tree 170.
612. JAMES H MORGAN (John's great-great-grandson) was born in 1893, in Clyro, Radnorshire, UK, to William MORGAN⁶⁸⁴ and Sarah Sophia MORGAN [LLOYD]⁶⁸³, as shown in family tree 170.
613. EVA PUGH [GRIFFITHS] (John's great-great-granddaughter) was born in 1901, in Bryngwyn, Radnorshire, UK, to Thomas GRIFFITHS⁶⁹¹ and Fortune GRIFFITHS [DAVIES]⁶⁹², as shown in family tree 171. Eva died in 1990, aged about 89.
614. DAVID PUGH (John's great-great-granddaughter's husband) was born in 1895, in Hay, Brecknockshire. See family tree 147.
David PUGH, aged about 33, married Eva PUGH [GRIFFITHS]⁶¹³, aged about 27, in 1928 in Hay, Brecknockshire. They had six children:
Edward (Eddie) PUGH⁴⁶¹ in 1929
Joyce Margaret DAVIES [PUGH]⁴⁶² in 1931
Betty JAMES [PUGH]⁴⁶⁴
Margaret PUGH⁴⁶⁶
Ruth POWELL [PUGH]⁴⁶⁷
Barbara PUGH⁴⁶⁹
This family is shown as family tree 147.
615. THOMAS CLEMENT J GRIFFITHS (John's great-great-grandson) was born in 1902 to Thomas GRIFFITHS⁶⁹¹ and Fortune GRIFFITHS [DAVIES]⁶⁹², as shown in family tree 171. Thomas died in 1973, aged about 71.
616. BLANCHE PEVERILL (John's great-great-grandson's wife) was born in 1891, in Yeovil. See family tree 148. Blanche married three times. She was married to Charles MASTERS, George WEAVER and Thomas Clement J GRIFFITHS⁶¹⁵.
Note: *Note 59.*
Charles MASTERS married Blanche PEVERILL, aged about 28, in 1919 in Kensington, UK.
George WEAVER married Blanche PEVERILL, aged about 29, in 1920 in Crickhowell.
Note: *Q1 (Marriage).*
Thomas Clement J GRIFFITHS⁶¹⁵, aged about 25, married Blanche PEVERILL, aged about 36, in 1927 in Brecknock, UK. They had four children:
Lesley M BASTIN [GRIFFITHS]⁴⁷⁰ in 1928
Peter GRIFFITHS⁴⁷² in 1929
Marjorie Sally SMITHERS [GRIFFITHS]⁴⁷³ in 1931
Pamela M GRIFFITHS [GRIFFITHS]⁴⁷⁵ in 1932
This family is shown as family tree 148.
Note: *Q4 (Marriage).*
617. ARTHUR GRIFFITHS (John's great-great-grandson) was born in 1903 to Thomas GRIFFITHS⁶⁹¹ and Fortune GRIFFITHS [DAVIES]⁶⁹², as shown in family tree 171.
618. MAUD GRIFFITHS [EVANS] (John's great-great-grandson's wife). See family tree 149.
Arthur GRIFFITHS⁶¹⁷ married Maud GRIFFITHS [EVANS]. They had one daughter:
Pamela LEWIS [GRIFFITHS]⁴⁷⁷ in 1942
This family is shown as family tree 149.
619. JANE LLOYD (John's great-great-granddaughter) was born to Sarah Ann LLOYD⁶⁹³, as shown in family tree 172.
620. WILLIAM HENRY LLOYD (John's great-great-grandson) was born on 2 April 1899, in Michaelchurch, to John LLOYD⁷⁰¹ and Rachel LLOYD [REES]⁷⁰², as shown in family tree 173.
621. GWENDOLINE GERTRUDE WHITTALL [LLOYD] (John's great-great-granddaughter) was born on 30 March 1900 to John LLOYD⁷⁰¹ and Rachel LLOYD [REES]⁷⁰², as shown in family tree 173. Gwendoline died in 1976, aged about 76.
622. IVOR WHITTALL (John's great-great-granddaughter's husband). See family tree 150.
Ivor WHITTALL married Gwendoline Gertrude WHITTALL [LLOYD]⁶²¹. They had two children:
Mary WHITTALL⁴⁷⁹
John WHITTALL⁴⁸⁰
This family is shown as family tree 150.
623. JANE SOPHIA POWELL [LLOYD] (John's great-great-granddaughter) was born in 1901 to John LLOYD⁷⁰¹ and Rachel LLOYD [REES]⁷⁰², as shown in family tree 173. Jane died in 1972, aged about 71.
624. THOMAS JOHN POWELL (John's great-great-granddaughter's husband). See family tree 151.

Thomas John POWELL married Jane Sophia POWELL [LLOYD]⁶²³. They had seven children:

Kathleen Mary POWELL⁴⁸² in 1924
 Dorothy May JONES [POWELL]⁴⁸³ in 1925
 Gwendoline Jane (Babs) INGRAM [POWELL]⁴⁸⁵ in 1926
 Thomas John POWELL⁴⁸⁷ in 1928
 Elizabeth Rachel PRICE [POWELL]⁴⁸⁹ in 1931
 Kenneth Charles POWELL⁴⁹¹ in 1933
 Edith Margaret DAVIES [POWELL]⁴⁹³ in 1935

This family is shown as family tree 151.

625. EDITH MARY POWELL [LLOYD] (John's great-great-granddaughter) was born in 1904 to John LLOYD⁷⁰¹ and Rachel LLOYD [REES]⁷⁰², as shown in family tree 173.

626. WILLIAM BADEN POWELL (John's great-great-granddaughter's husband) was born in 1900. See family tree 152. William Baden POWELL, aged about 31, married Edith Mary POWELL [LLOYD]⁶²⁵, aged about 27, in 1931 in Kington. They had five children:

Lena Mary POWELL⁴⁹⁵ in 1932
 Jeanette BOWEN [POWELL]⁴⁹⁷ in 1933
 William Owen POWELL⁴⁹⁹ in 1934
 Robert Lloyd POWELL⁵⁰¹ in 1938
 Ms. ILES [POWELL]⁵⁰³ in 1940

This family is shown as family tree 152.

627. SARAH JANE (JANEY) JAMES [LLOYD] (John's great-great-granddaughter) was born in 1881 to James LLOYD⁷⁰³ and Harriett LLOYD [DREW]⁷⁰⁴, as shown in family tree 174. Sarah died in 1964, aged about 83.

Note: *Note 60.*

628. HENRY (HAROLD) JAMES (John's great-great-granddaughter's husband). See family tree 153.

Henry (Harold) JAMES married Sarah Jane (Janey) JAMES [LLOYD]⁶²⁷, aged about 29, in 1910 in Kington. They had five children:

Albert JAMES⁵⁰⁵
 Phyllis WILLIAMS [JAMES]⁵⁰⁶ in 1910
 Mary JAMES⁵⁰⁸ in 1915
 Dennis JAMES⁵¹¹
 Margeurite J MORGAN [JAMES]⁵¹² in 1921

This family is shown as family tree 153.

Note: *Q2 (Marriage).*

629. WILLIAM LLOYD (John's great-great-grandson) was born in 1883 to James LLOYD⁷⁰³ and Harriett LLOYD [DREW]⁷⁰⁴, as shown in family tree 174.

Note: *Note 61.*

630. PATTY LLOYD [LEWIS] (John's great-great-grandson's wife).

William LLOYD⁶²⁹ married Patty LLOYD [LEWIS].

631. THOMAS LLOYD (John's great-great-grandson) was born in 1884 to James LLOYD⁷⁰³ and Harriett LLOYD [DREW]⁷⁰⁴, as shown in family tree 174. Thomas died in 1947, aged about 63.

Note: *Note 62.*

632. MARGARET JANE LLOYD [PRITCHARD] (John's great-great-grandson's wife) was born in 1883. See family tree 154. Margaret died in 1969, aged about 86.

Thomas LLOYD⁶³¹, aged about 26, married Margaret Jane LLOYD [PRITCHARD], aged about 27, in 1910 in Kington. They had two sons:

Vincent LLOYD⁵¹⁴ in 1912
 Walter LLOYD⁵¹⁵ in 1913

This family is shown as family tree 154.

Note: *Q2 (Marriage).*

633. JOHN LLOYD (John's great-great-grandson) was born in 1887 to James LLOYD⁷⁰³ and Harriett LLOYD [DREW]⁷⁰⁴, as shown in family tree 174. John died on 30 August 1887, as an infant, in (6 Months). He was buried in Michaelchurch.

634. JOHN LLOYD (John's great-great-grandson) was born in 1889 to James LLOYD⁷⁰³ and Harriett LLOYD [DREW]⁷⁰⁴, as shown in family tree 174. John died on 3 March 1932, aged about 42.

Note: *Note 63.*

635. JAMES LLOYD (John's great-great-grandson) was born in 1891 to James LLOYD⁷⁰³ and Harriett LLOYD [DREW]⁷⁰⁴, as shown in family tree 174. James died on 10 April 1969, aged about 77. He was buried in Michaelchurch.

Note: *Note 64.*

636. SARAH ANN LLOYD [HAMER] (John's great-great-grandson's wife) was born in 1889. See family tree 155. Sarah died on 21 May 1957, aged about 67.
 James LLOYD⁶³⁵, aged about 25, married Sarah Ann LLOYD [HAMER], aged about 27, in 1916 in Kington. They had five children:
 James Hamer LLOYD⁵¹⁷
 Emily Maud DUGGAN [LLOYD]⁵¹⁹
 Evan Rice LLOYD⁵²¹ in 1921
 Henry Charles LLOYD⁵²³ in 1923
 Joan POWELL [LLOYD]⁵²⁵
This family is shown as family tree 155.
 Note: *Q2 (Marriage).*
637. CHARLES LLOYD (John's great-great-grandson) was born in 1893 to James LLOYD⁷⁰³ and Harriett LLOYD [DREW]⁷⁰⁴, as shown in family tree 174. Charles died in 1973, aged about 80.
 Note: *Note 65.*
638. LILY MAY (AKA DORIS) LLOYD [EVANS] (John's great-great-grandson's wife) was born in 1894, in Ledbury. See family tree 156. Lily died on 22 April 1973, aged about 78.
 Charles LLOYD⁶³⁷, aged about 23, married Lily May (aka Doris) LLOYD [EVANS], aged about 22, in 1916 in Kington. They had six children:
 Ethel Elizabeth LLOYD⁵²⁷ in 1917
 Charles G LLOYD⁵²⁸ in 1918
 Edward (Ted) A LLOYD⁵²⁹ in 1921
 Hilde LLOYD⁵³⁰ in 1924
 Dorothy Mary LLOYD⁵³¹ in 1930
 Marian Jane LLOYD⁵³² in 1934
This family is shown as family tree 156.
 Note: *Q3 (Marriage).*
639. HUGH LLOYD (John's great-great-grandson) was born in 1896, in Gladestry, to James LLOYD⁷⁰³ and Harriett LLOYD [DREW]⁷⁰⁴, as shown in family tree 174.
 Note: *Note 66.*
640. FRANCES LLOYD [EDITH] (John's great-great-grandson's wife). See family tree 157.
 Hugh LLOYD⁶³⁹ married Frances LLOYD [EDITH]. They had one son:
 Graham Hugh LLOYD⁵³³ in 1920
This family is shown as family tree 157.
641. DANZEY EVAN LLOYD (John's great-great-grandson) was born in 1899 to James LLOYD⁷⁰³ and Harriett LLOYD [DREW]⁷⁰⁴, as shown in family tree 174. Danzey was a Farmer At Newhouse, Bryngwyn. Danzey died in 1974, aged about 75, in Cherry Trees, Hay On Wye.
 Note: *Note 67.*
642. GERTRUDE LLOYD [JONES] (John's great-great-grandson's wife) was born in 1901. See family tree 158.
 Danzey Evan LLOYD⁶⁴¹ married Gertrude LLOYD [JONES]. They had three children:
 Roland LLOYD⁵³⁴ in 1926
 Mona LLOYD⁵³⁵ in 1926
 Alice May (Diddy) LLOYD⁵³⁶ in 1930
This family is shown as family tree 158.
643. MARGARET JANE MORGAN [LLOYD] (John's great-great-granddaughter) was born in 1888 to Hugh LLOYD⁷⁰⁵ and Margaret LLOYD [REES]⁷⁰⁶, as shown in family tree 175.
 Note: *Note 68.*
644. CLIFF MORGAN (John's great-great-granddaughter's husband).
 Cliff MORGAN married Margaret Jane MORGAN [LLOYD]⁶⁴³.
645. HUGH LLOYD (John's great-great-grandson) was born on 30 March 1891 to Hugh LLOYD⁷⁰⁵ and Margaret LLOYD [REES]⁷⁰⁶, as shown in family tree 175. Hugh died in 1976, aged about 85.
 Note: *Note 69.*



646. SUSANNAH LLOYD [GODWIN] (John's great-great-grandson's wife) was born in 1896. See family tree 159. Susannah died in 1980, aged about 84.
 Note: *Note 70.*

Hugh LLOYD⁶⁴⁵ married Susannah LLOYD [GODWIN]. They had three children:
 Hugh LLOYD⁵³⁸ in 1918
 Doris PHILLIPS [LLOYD]⁵⁴⁰ in 1924
 Elizabeth Nancy LEWIS [LLOYD]⁵⁴² in 1931
This family is shown as family tree 159.

647. WILLIAM LLOYD (John's great-great-grandson) was born in 1893 to Hugh LLOYD⁷⁰⁵ and Margaret LLOYD [REES]⁷⁰⁶, as shown in family tree 175. William resided at Emigrated to America.
 Note: *Note 71.*
648. CATHERINE (KITTY) LLOYD (John's great-great-granddaughter) was born in 1896 to Hugh LLOYD⁷⁰⁵ and Margaret LLOYD [REES]⁷⁰⁶, as shown in family tree 175. Catherine died in 1974, aged about 78.
 Note: *Note 72.*
649. JOHN (JACK ?) LLOYD (John's great-great-grandson) was born in 1899 to Hugh LLOYD⁷⁰⁵ and Margaret LLOYD [REES]⁷⁰⁶, as shown in family tree 175. John died in 1976, aged about 77.
 Note: *Note 73.*
650. MARY EILEEN LLOYD [HAMER] (John's great-great-grandson's wife).
 John (Jack ?) LLOYD⁶⁴⁹ married Mary Eileen LLOYD [HAMER].
651. JAMES LLOYD (John's great-great-grandson) was born in 1901 to Hugh LLOYD⁷⁰⁵ and Margaret LLOYD [REES]⁷⁰⁶, as shown in family tree 175. James died in 1979, aged about 78.
652. ANNE LLOYD [PHILLIPS] (John's great-great-grandson's wife). See family tree 160. Anne died on 1 March 2005.
 James LLOYD⁶⁵¹ married Anne LLOYD [PHILLIPS]. They had one daughter:
 Margaret PRICE [LLOYD]⁵⁴⁴
This family is shown as family tree 160.
653. MATTHEW JOHN LLOYD (John's great-great-grandson) was born in 1877, in Llanvelliion, to Thomas LLOYD⁷¹¹ and Sarah Ann LLOYD [HARVARD]⁷¹², as shown in family tree 176.
654. SARAH ANN PITT [LLOYD] (John's great-great-granddaughter) was born in 1878, in Llanvelliion, to Thomas LLOYD⁷¹¹ and Sarah Ann LLOYD [HARVARD]⁷¹², as shown in family tree 176.
655. HARRY ARTHUR PITT ? (John's great-great-granddaughter's husband).
 Harry Arthur PITT ? married Sarah Ann PITT [LLOYD]⁶⁵⁴, aged about 28, in 1906 in Hay on Wye.
656. THOMAS HUGH LLOYD (John's great-great-grandson) was born in 1881, in Crickhowell, to Thomas LLOYD⁷¹¹ and Sarah Ann LLOYD [HARVARD]⁷¹², as shown in family tree 176.
 Thomas married twice. He was married to Eva May LLOYD [CLARKE]⁶⁵⁷ and Beatrice Eva LLOYD [LEWIS]⁶⁵⁸.
 Note: *Note 74.*
657. EVA MAY LLOYD [CLARKE] (John's great-great-grandson's wife) was born in 1889. See family tree 161. Eva died in 1919, aged about 30, in Knighton.
 Note: *Q1 (Death).*
 Thomas Hugh LLOYD⁶⁵⁶, aged about 31, married Eva May LLOYD [CLARKE], aged about 23, in 1912 in Crickhowell. They had two daughters:
 Mildred LLOYD⁵⁴⁶ in 1914
 Rosa J LLOYD⁵⁴⁷ in 1916
This family is shown as family tree 161.
 Note: *Q2 (Marriage).*
658. BEATRICE EVA LLOYD [LEWIS] (John's great-great-grandson's wife) was born in 1889, in Crickhowell. See family tree 162.
 Note: *Q1 (Birth).*
 Thomas Hugh LLOYD⁶⁵⁶, aged about 41, married Beatrice Eva LLOYD [LEWIS], aged about 33, in 1922 in Crickhowell. They had three children:
 Arther E LLOYD⁵⁴⁸ in 1922
 Hilda E LLOYD⁵⁴⁹ in 1924
 Edith A LLOYD⁵⁵⁰ in 1926
This family is shown as family tree 162.
659. ELIZABETH LLOYD (John's great-great-granddaughter) was born to Thomas LLOYD⁷¹¹ and Sarah Ann LLOYD [HARVARD]⁷¹², as shown in family tree 176.
660. EMILY LLOYD (John's great-great-granddaughter) was born in 1889, in Crickhowell, to Edward Lewis LLOYD⁷¹³ and Catherine LLOYD [POWELL]⁷¹⁴, as shown in family tree 177.
661. LILLIAN LLOYD (John's great-great-granddaughter) was born in 1898, in Hay, to Evan LLOYD⁷¹⁷ and Emma Eliza LLOYD [BOND]⁷¹⁸, as shown in family tree 178.

662. WILLIAM LLOYD (John's great-great-grandson) was born in 1901, in Hay, to Evan LLOYD⁷¹⁷ and Emma Eliza LLOYD [BOND]⁷¹⁸, as shown in family tree 178.
663. HERBERT LLOYD (John's great-great-grandson) was born in 1907, in Hay, to Evan LLOYD⁷¹⁷ and Emma Eliza LLOYD [BOND]⁷¹⁸, as shown in family tree 178.
664. ELEANOR EDITH MEREDITH (John's great-great-granddaughter) was born in 1902 to David Thomas MEREDITH⁷²⁴ and Elizabeth MEREDITH [LLOYD]⁷²³, as shown in family tree 179.
665. HILDA ELIZABETH MEREDITH (John's great-great-granddaughter) was born in 1904 to David Thomas MEREDITH⁷²⁴ and Elizabeth MEREDITH [LLOYD]⁷²³, as shown in family tree 179.
666. WINIFRED SARAH MEREDITH (John's great-great-granddaughter) was born in 1908, in Glamorgan, to David Thomas MEREDITH⁷²⁴ and Elizabeth MEREDITH [LLOYD]⁷²³, as shown in family tree 179.

Generation of Great-Grandchildren

667. JOHN LLOYD (John's great-grandson) was born in 1842 to John LLOYD⁷³⁷ and Ann LLOYD [MAINWARING]⁷³⁸, as shown in family tree 180. John died on 14 February 1861, aged about 18. He was buried in Michaelchurch.
Note: *Note 75.*
668. ANN MEREDITH [LLOYD] (John's great-granddaughter) was born on 3 March 1840, in Glascwm, to Thomas LLOYD⁷³⁹ and Sophia LLOYD⁷⁴⁰, as shown in family tree 181. Ann died in 1894, aged about 54. She was buried in Glascwm.
669. SAMUEL MEREDITH (John's great-granddaughter's husband) was born in 1828, in Glascwm. See family tree 163. Samuel was a Farmer. Samuel died on 28 May 1905, aged about 76. He was buried in Glascwm.

Note: *Note 76.*

Samuel MEREDITH, aged about 30, married Ann MEREDITH [LLOYD]⁶⁶⁸, aged 18, on 9 October 1858 in Glascwm. They had four children:

Elizabeth Ann (Eliza) LLOYD [MEREDITH]⁵⁵¹ in 1861

Samuel MEREDITH⁵⁵³ in 1865

Thomas MEREDITH⁵⁵⁴ in 1868

Annie GOODWIN [MEREDITH]⁵⁵⁵ in 1871

This family is shown as family tree 163.

670. THOMAS LLOYD (John's great-grandson) was born in 1842, in Glascwm, to Thomas LLOYD⁷³⁹ and Sophia LLOYD⁷⁴⁰, as shown in family tree 181. He was christened on 1 May 1842. He was a Farmer And Bonesetter. Thomas died on 1 August 1900, aged about 58. Thomas was buried in Llangunllo.
Note: *Note 77.*



671. MARGARET LLOYD [CONNOP] (John's great-grandson's wife) was born in 1842, in Eardisley, Hereford, England. See family tree 164. Margaret died on 26 May 1908, aged about 65. She was buried in Llangunllo.

Thomas LLOYD⁶⁷⁰, aged about 24, married Margaret LLOYD [CONNOP], aged about 24, in 1866 in Presteigne. They had ten children:

Hugh Caleb LLOYD⁵⁵⁷ in 1865

James Thomas (Tom) LLOYD⁵⁵⁸ in 1866

Margaret DREW [LLOYD]⁵⁵⁹ in 1868

Elizabeth DAVIES [LLOYD]⁵⁶¹ in 1870

Mary Ann (Polly) WILLIAMS [LLOYD]⁵⁶³ in 1872

John Evan LLOYD⁵⁶⁵ in 1876

Sarah Rosa BYWATER [LLOYD]⁵⁶⁶ in 1877

Ann Sophia ROBERTS [LLOYD]⁵⁶⁸ in 1880

Ada Agnes BYWATER [LLOYD]⁵⁷⁰ in 1883

Minnie Gladys LLOYD⁵⁷² in 1888

This family is shown as family tree 164.

Note: *Q2 (Marriage).*

672. MARY LLOYD (John's great-granddaughter) was born in 1842 to Thomas LLOYD⁷³⁹ and Sophia LLOYD⁷⁴⁰, as shown in family tree 181. She was christened on 1 May 1842. Mary died on 26 March 1912, aged about 69, in Blaenbeddew. She was buried in Glascwm.

Note: Note 78.

673. HUGH LLOYD (John's great-grandson) was born in 1844 to Thomas LLOYD⁷³⁹ and Sophia LLOYD⁷⁴⁰, as shown in family tree 181. Hugh died on 26 June 1890, aged about 45.

Notes:

- Note 79.
- *Flu Epidemic (Death)*.

674. MARTHA LLOYD [POWELL] (John's great-grandson's wife) was born in 1864. See family tree 165. Martha died on 3 July 1890, aged about 26.



Notes:

- Note 80.
- *Flu Epidemic (Death)*.

Hugh LLOYD⁶⁷³, aged about 41, married Martha LLOYD [POWELL], aged about 21, in 1885 in Wrexham, Denbighshire. They had two children:

Hugh LLOYD⁵⁷³ in 1888

Annie Sophia (aka Nancy) LLOYD⁵⁷⁷ in 1890

This family is shown as family tree 165.

675. JOHN LLOYD (John's great-grandson) was born in 1846 to Thomas LLOYD⁷³⁹ and Sophia LLOYD⁷⁴⁰, as shown in family tree 181. John died on 27 May 1879, aged about 32, in Llanpica. He was buried on 31 May 1879 in Michaelchurch.

Note: Note 81.

676. MARY ANN LLOYD [DAVIES] (John's great-grandson's wife). See family tree 166.

John LLOYD⁶⁷⁵, aged about 28, married Mary Ann LLOYD [DAVIES] on 24 November 1874 in Michaelchurch.

They had one daughter:

Anne LLOYD⁵⁸⁰

This family is shown as family tree 166.

677. ELIZABETH (BESSIE) JAMES [LLOYD] (John's great-granddaughter) was born in 1847 to Thomas LLOYD⁷³⁹ and Sophia LLOYD⁷⁴⁰, as shown in family tree 181. Elizabeth died in 1915, aged about 68.

678. JAMES JAMES (John's great-granddaughter's husband). See family tree 167.

Note: Note 82.

James JAMES married Elizabeth (Bessie) JAMES [LLOYD]⁶⁷⁷, aged about 24, in 1871 in Kington. They had one daughter:

Elizabeth Ann (Lizzie) DAVIES [JAMES]⁵⁸¹ in 1872

This family is shown as family tree 167.

Note: Q3 (Marriage).

679. WILLIAM LLOYD (John's great-grandson) was born in 1850, in Cwmshenkin, Glascwm, to Thomas LLOYD⁷³⁹ and Sophia LLOYD⁷⁴⁰, as shown in family tree 181. William was a Farmer/Farm Labourer. William died on 7 August 1923, aged about 73, in Kington. He was buried in Michaelchurch.



Note: Note 83.

680. SARAH LLOYD [MILWARD] (John's great-grandson's wife) was born in 1849, in Llanfihangell. See family tree 168. Sarah died in 1932, aged about 83, in Blaenpeak, Brilly Mountain, UK. She was buried in Michaelchurch.

Notes:

- Note 84.
- Q3 (Birth).

William LLOYD⁶⁷⁹, aged about 19, married Sarah LLOYD [MILWARD], aged about 20, in 1869 in Pentwyn, Gladestry. They had twelve children:

Adeliza Ann LLOYD⁵⁸³ in 1870

William Bayley LLOYD⁵⁸⁴ in 1871

Sophia Matilda (Tillie) EVES [LLOYD]⁵⁸⁵ in 1872

Elizabeth Anne (Annie) LANE [LLOYD]⁵⁸⁷ in 1876

Alice LLOYD⁵⁸⁹ in 1878

Charles LLOYD⁵⁹⁰ in 1880

Gladys LLOYD⁵⁹¹ in 1881

Hugh LLOYD⁵⁹² in 1883

Thomas John LLOYD⁵⁹⁴ in 1885

Evan Sidney LLOYD⁵⁹⁶ in 1887

Sarah Janet STRATTON [LLOYD]⁵⁹⁸ in 1890

Edith LLOYD⁶⁰⁰ in 1893

This family is shown as family tree 168.

681. EVAN LLOYD (John's great-grandson) was born in 1852, in Cwmshenkin, Glascwm, to Thomas LLOYD⁷³⁹ and Sophia LLOYD⁷⁴⁰, as shown in family tree 181. He was christened on 22 March 1852, in Glascwm. He was a Bonesetter And Farmer. Evan died on 19 December 1912, aged about 60. Evan was buried in Michaelchurch. Note: *Note 85*.



682. CLARA LLOYD [HILL] (John's great-grandson's wife) was born in 1861, in Brilley. See family tree 169. Clara died in 1939, aged about 78. Note: *Note 86*.



Evan LLOYD⁶⁸¹ married Clara LLOYD [HILL] in No record found. They had four children:

Evan Thomas LLOYD FRSM, MBMA, MRSI⁶⁰¹ in 1887

Elizabeth Florence LLOYD⁶⁰² in 1890

Annie Clara LLOYD⁶⁰³ in 1896

Ada Marion GITTOES [LLOYD]⁶⁰⁴ in 1901

This family is shown as family tree 169.

683. SARAH SOPHIA MORGAN [LLOYD] (John's great-granddaughter) was born in 1857, in Glascwm, to Thomas LLOYD⁷³⁹ and Sophia LLOYD⁷⁴⁰, as shown in family tree 181. Sarah died in 1893, aged about 36, in Hay, Brecknockshire. Note: *Q3 (Death)*.

684. WILLIAM MORGAN (John's great-granddaughter's husband) was born in 1851, in Clifford, Hereford. See family tree 170. William was a Farmer Of 170 Acres, Employing 2 Men. He resided at Great House. He resided at Bryngwyn, Radnor. Note: *Note 87*.

William MORGAN, aged about 27, married Sarah Sophia MORGAN [LLOYD]⁶⁸³, aged about 21, in 1878 in Kington. They had six children:

Sarah Anne MORGAN⁶⁰⁶ in 1879

Mary Elizabeth WILLIAMS [MORGAN]⁶⁰⁷ in 1880

William Thomas MORGAN⁶⁰⁹ in 1883

Evan John Lloyd MORGAN⁶¹⁰ in 1885

Edward G MORGAN⁶¹¹ in 1891

James H MORGAN⁶¹² in 1893

This family is shown as family tree 170.

Note: *Q2 (Marriage)*.

685. JOHN DAVIES (John's great-grandson) was born in 1834 to John DAVIES⁷⁴² and Ann DAVIES [LLOYD]⁷⁴¹, as shown in family tree 182.

686. THOMAS DAVIES (John's great-grandson) was born in 1836 to John DAVIES⁷⁴² and Ann DAVIES [LLOYD]⁷⁴¹, as shown in family tree 182.

687. ANNE DAVIES (John's great-granddaughter) was born in 1839 to John DAVIES⁷⁴² and Ann DAVIES [LLOYD]⁷⁴¹, as shown in family tree 182.

688. LLOYD DAVIES (John's great-grandson) was born in 1845 to John DAVIES⁷⁴² and Ann DAVIES [LLOYD]⁷⁴¹, as shown in family tree 182.

689. JAMES DAVIES (John's great-grandson) was born in 1847 to John DAVIES⁷⁴² and Ann DAVIES [LLOYD]⁷⁴¹, as shown in family tree 182.

690. EDWARD DAVIES (John's great-grandson) was born in 1850 to John DAVIES⁷⁴² and Ann DAVIES [LLOYD]⁷⁴¹, as shown in family tree 182.

691. THOMAS GRIFFITHS (John's great-grandson) was born on 17 August 1843 to John GRIFFITHS⁷⁴⁴ and Mary GRIFFITHS [LLOYD]⁷⁴³, as shown in family tree 183. Thomas died on 26 May 1924, aged 80. Note: *Note 88*.

692. FORTUNE GRIFFITHS [DAVIES] (John's great-grandson's wife) was born in 1862, in Cefnlllys, Radnorshire, Wales. See family tree 171. Fortune died on 16 December 1937, aged about 75, in Bryngwyn, Radnorshire, UK. Note: *Note 89*.

Thomas GRIFFITHS⁶⁹¹, aged about 57, married Fortune GRIFFITHS [DAVIES], aged about 39, in 1901 in Strand, London. They had three children:

Eva PUGH [GRIFFITHS]⁶¹³ in 1901

Thomas Clement J GRIFFITHS⁶¹⁵ in 1902

Arthur GRIFFITHS⁶¹⁷ in 1903

This family is shown as family tree 171.

693. SARAH ANN LLOYD (John's great-granddaughter) was born in 1847, in Old Radnor, to Richard LLOYD⁷⁴⁵ and Sarah LLOYD [PROBERT]⁷⁴⁶, as shown in family tree 184. Sarah was a Housekeeper At Baynham Hall Around 1895.
Notes:
• *Note 90.*
• *1851 Census (Birth).*
Sarah gave birth to one daughter:
Jane LLOYD⁶¹⁹
This family is shown as family tree 172.
694. JEFFREY THOMAS LLOYD (John's great-grandson) was born in 1849, in Old Radnor, to Richard LLOYD⁷⁴⁵ and Sarah LLOYD [PROBERT]⁷⁴⁶, as shown in family tree 184.
Note: *1851 Census (Birth).*
695. RICHARD LLOYD (John's great-grandson) was born in 1854, in Michaelchurch, to Richard LLOYD⁷⁴⁵ and Sarah LLOYD [PROBERT]⁷⁴⁶, as shown in family tree 184. Richard was a Worked At Baynham. Richard died in Knighton.
Notes:
• *Note 91.*
• *1861 Census (Birth).*
696. MARY ANN (POLLY) FRANCIS [LLOYD] (John's great-granddaughter) was born in 1857, in Brilley, to Richard LLOYD⁷⁴⁵ and Sarah LLOYD [PROBERT]⁷⁴⁶, as shown in family tree 184.
697. THOMAS FRANCIS (John's great-granddaughter's husband) was born in 1866, in Knighton. Thomas died in 1957, aged about 91.
Thomas FRANCIS married Mary Ann (Polly) FRANCIS [LLOYD]⁶⁹⁶.
698. ANNIE PHILLIPS [LLOYD] (John's great-granddaughter) was born in 1863, in Michaelchurch, to Richard LLOYD⁷⁴⁵ and Sarah LLOYD [PROBERT]⁷⁴⁶, as shown in family tree 184.
Note: *Note 92.*
699. EDWARD BAKER PHILLIPS (John's great-granddaughter's husband) was born in 1858, in Presteigne.
Note: *Q1 (Birth).*
Edward Baker PHILLIPS, aged about 29, married Annie PHILLIPS [LLOYD]⁶⁹⁸, aged about 24, in 1887 in Kington.
Note: *Q4 (Marriage).*
700. WILLIAM LLOYD (John's great-grandson) was born in 1855, in Huntington, UK, to William LLOYD⁷⁴⁷ and Jane LLOYD [GRIFFITHS]⁷⁴⁸, as shown in family tree 185. William was a Bonesetter. William died on 1 April 1931, aged about 75. He was buried in Michaelchurch.
Note: *Note 93.*
701. JOHN LLOYD (John's great-grandson) was born in 1856, in Michaelchurch, to William LLOYD⁷⁴⁷ and Jane LLOYD [GRIFFITHS]⁷⁴⁸, as shown in family tree 185. John died on 23 November 1933, aged about 77.
702. RACHEL LLOYD [REES] (John's great-grandson's wife) was born in 1866, in Presteigne. See family tree 173. Rachel died on 6 April 1929, aged about 62.
Note: *Q3 (Birth).*
John LLOYD⁷⁰¹, aged about 43, married Rachel LLOYD [REES], aged about 33, in 1899 in Kington. They had four children:
William Henry LLOYD⁶²⁰ in 1899
Gwendoline Gertrude WHITTALL [LLOYD]⁶²¹ in 1900
Jane Sophia POWELL [LLOYD]⁶²³ in 1901
Edith Mary POWELL [LLOYD]⁶²⁵ in 1904
This family is shown as family tree 173.
Note: *Q1 (Marriage).*
703. JAMES LLOYD (John's great-grandson) was born in 1857, in Huntington, UK, to William LLOYD⁷⁴⁷ and Jane LLOYD [GRIFFITHS]⁷⁴⁸, as shown in family tree 185. James died on 9 December 1930, aged about 73. He was buried in Michaelchurch.
Note: *Note 94.*
704. HARRIETT LLOYD [DREW] (John's great-grandson's wife) was born in 1859, in Cefnlllys, Radnorshire, Wales. See family tree 174. Harriett died on 18 August 1922, aged about 63. She was buried in Michaelchurch.
Note: *Note 95.*
James LLOYD⁷⁰³, aged about 24, married Harriett LLOYD [DREW], aged about 22, in 1881 in Kington. They had nine children:
Sarah Jane (Janey) JAMES [LLOYD]⁶²⁷ in 1881
William LLOYD⁶²⁹ in 1883
Thomas LLOYD⁶³¹ in 1884
John LLOYD⁶³³ in 1887
John LLOYD⁶³⁴ in 1889

James LLOYD⁶³⁵ in 1891
 Charles LLOYD⁶³⁷ in 1893
 Hugh LLOYD⁶³⁹ in 1896
 Danzey Evan LLOYD⁶⁴¹ in 1899

This family is shown as family tree 174.
 Note: Q2 (Marriage).

705. HUGH LLOYD (John's great-grandson) was born in 1858, in Michaelchurch, to William LLOYD⁷⁴⁷ and Jane LLOYD [GRIFFITHS]⁷⁴⁸, as shown in family tree 185. Hugh died on 26 August 1937, aged about 79. He was buried in Michaelchurch.
 Note: Note 96.
706. MARGARET LLOYD [REES] (John's great-grandson's wife) was born in 1866, in Cefnlllys, Radnorshire, Wales. See family tree 175. Margaret died on 4 April 1951, aged about 84. She was buried in Michaelchurch.
 Note: Note 97.
 Hugh LLOYD⁷⁰⁵, aged about 29, married Margaret LLOYD [REES], aged about 21, on 29 March 1888 in Kington Baptist Chapel (By Licence). They had six children:
 Margaret Jane MORGAN [LLOYD]⁶⁴³ in 1888
 Hugh LLOYD⁶⁴⁵ in 1891
 William LLOYD⁶⁴⁷ in 1893
 Catherine (Kitty) LLOYD⁶⁴⁸ in 1896
 John (Jack ?) LLOYD⁶⁴⁹ in 1899
 James LLOYD⁶⁵¹ in 1901
This family is shown as family tree 175.
707. THOMAS LLOYD (John's great-grandson) was born in 1860, in Michaelchurch, to William LLOYD⁷⁴⁷ and Jane LLOYD [GRIFFITHS]⁷⁴⁸, as shown in family tree 185. Thomas died on 3 September 1884, aged about 24. He was buried in Michaelchurch.
708. CHARLES LLOYD (John's great-grandson) was born in 1861, in Michaelchurch, to William LLOYD⁷⁴⁷ and Jane LLOYD [GRIFFITHS]⁷⁴⁸, as shown in family tree 185. Charles died on 28 May 1939, aged about 77. He was buried in Michaelchurch.
 Note: Note 98.
709. HUGH LLOYD (John's great-grandson) was born on 30 April 1848 to Hugh LLOYD⁷⁴⁹ and Elizabeth LLOYD [LEWIS]⁷⁵⁰, as shown in family tree 186. Hugh died in 1849, aged about 1.
 Note: ? (Death).
710. JOHN LLOYD (John's great-grandson) was born on 10 November 1846, in Newchurch, to Hugh LLOYD⁷⁴⁹ and Sarah LLOYD [EVANS]⁷⁵¹, as shown in family tree 187. John died on 24 June 1867, aged 20.
711. THOMAS LLOYD (John's great-grandson) was born on 31 August 1850, in Bryngwyn, to Hugh LLOYD⁷⁴⁹ and Sarah LLOYD [EVANS]⁷⁵¹, as shown in family tree 187. Thomas was a Bonesetter. Thomas died in 1930, aged about 79.
 Note: Note 99.
712. SARAH ANN LLOYD [HARVARD] (John's great-grandson's wife) was born in 1858, in Nartyd. See family tree 176. Thomas LLOYD⁷¹¹, aged about 25, married Sarah Ann LLOYD [HARVARD], aged about 18, in 1876 in Crickhowell. They had four children:
 Matthew John LLOYD⁶⁵³ in 1877
 Sarah Ann PITT [LLOYD]⁶⁵⁴ in 1878
 Thomas Hugh LLOYD⁶⁵⁶ in 1881
 Elizabeth LLOYD⁶⁵⁹
This family is shown as family tree 176.
 Note: Q3 (Marriage).
713. EDWARD LEWIS LLOYD (John's great-grandson) was born in 1853, in Bryngwyn, to Hugh LLOYD⁷⁴⁹ and Sarah LLOYD [EVANS]⁷⁵¹, as shown in family tree 187.
714. CATHERINE LLOYD [POWELL] (John's great-grandson's wife) was born in 1852, in Glanant. See family tree 177. Edward Lewis LLOYD⁷¹³, aged about 26, married Catherine LLOYD [POWELL], aged about 27, in 1879 in Crickhowell. They had one daughter:
 Emily LLOYD⁶⁶⁰ in 1889
This family is shown as family tree 177.
 Note: Q4 (Marriage).
715. MARY LLOYD (John's great-granddaughter) was born in 1861, in Hay, to Hugh LLOYD⁷⁴⁹ and Sarah LLOYD [EVANS]⁷⁵¹, as shown in family tree 187.

Note: *Q1 (Birth)*.

716. WILLIAM LLOYD (John's great-grandson) was born in 1865 to Hugh LLOYD⁷⁴⁹ and Sarah LLOYD [EVANS]⁷⁵¹, as shown in family tree 187.
717. EVAN LLOYD (John's great-grandson) was born in 1867 to Hugh LLOYD⁷⁴⁹ and Sarah LLOYD [EVANS]⁷⁵¹, as shown in family tree 187.
718. EMMA ELIZA LLOYD [BOND] (John's great-grandson's wife) was born in 1867. See family tree 178.
Evan LLOYD⁷¹⁷, aged about 25, married Emma Eliza LLOYD [BOND], aged about 25, in 1892 in Hay. They had three children:
Lillian LLOYD⁶⁶¹ in 1898
William LLOYD⁶⁶² in 1901
Herbert LLOYD⁶⁶³ in 1907
This family is shown as family tree 178.
719. ALICE LLOYD (John's great-granddaughter) was born in 1869 to Hugh LLOYD⁷⁴⁹ and Sarah LLOYD [EVANS]⁷⁵¹, as shown in family tree 187.
720. PRICE JOHN LLOYD (John's great-grandson) was born in 1871 to Hugh LLOYD⁷⁴⁹ and Sarah LLOYD [EVANS]⁷⁵¹, as shown in family tree 187.
721. SARAH ANN LLOYD (John's great-granddaughter) was born in 1873 to Hugh LLOYD⁷⁴⁹ and Sarah LLOYD [EVANS]⁷⁵¹, as shown in family tree 187.
722. ARTHUR LLOYD (John's great-grandson) was born in 1874, in Bryngwyn, to Hugh LLOYD⁷⁴⁹ and Sarah LLOYD [EVANS]⁷⁵¹, as shown in family tree 187.
723. ELIZABETH MEREDITH [LLOYD] (John's great-granddaughter) was born in 1876, in Llanstephen, to Hugh LLOYD⁷⁴⁹ and Sarah LLOYD [EVANS]⁷⁵¹, as shown in family tree 187.
724. DAVID THOMAS MEREDITH (John's great-granddaughter's husband) was born in 1875, in Llanchanges. See family tree 179. David was a Railway Station Master.
David Thomas MEREDITH, aged about 25, married Elizabeth MEREDITH [LLOYD]⁷²³, aged about 24, in 1900 in Hay. They had three daughters:
Eleanor Edith MEREDITH⁶⁶⁴ in 1902
Hilda Elizabeth MEREDITH⁶⁶⁵ in 1904
Winifred Sarah MEREDITH⁶⁶⁶ in 1908
This family is shown as family tree 179.
725. JAMES EVANS (John's great-grandson) was born in 1848 to James EVANS⁷⁵³ and Sarah EVANS [LLOYD]⁷⁵², as shown in family tree 188. James died in 1852, aged about 4.
726. JOHN EVANS (John's great-grandson) was born in 1850 to James EVANS⁷⁵³ and Sarah EVANS [LLOYD]⁷⁵², as shown in family tree 188. John died in 1852, aged about 2.
727. SARAH ANN EVANS (John's great-granddaughter) was born in 1852 to James EVANS⁷⁵³ and Sarah EVANS [LLOYD]⁷⁵², as shown in family tree 188. Sarah died in 1852, as an infant, in (2 Weeks).
728. JOHN EVANS (John's great-grandson) was born in 1855, in Blaenpeak, Brilly Mountain, UK, to James EVANS⁷⁵³ and Sarah EVANS [LLOYD]⁷⁵², as shown in family tree 188.
729. HUGH LLOYD EVANS (John's great-grandson) was born in 1858, in Blaenpeak, Brilly Mountain, UK, to James EVANS⁷⁵³ and Sarah EVANS [LLOYD]⁷⁵², as shown in family tree 188.
730. THOMAS EVANS (John's great-grandson) was born in 1861, in Blaenpeak, Brilly Mountain, UK, to James EVANS⁷⁵³ and Sarah EVANS [LLOYD]⁷⁵², as shown in family tree 188.
731. WILLIAM EVANS (John's great-grandson) was born in 1863, in Blaenpeak, Brilly Mountain, UK, to James EVANS⁷⁵³ and Sarah EVANS [LLOYD]⁷⁵², as shown in family tree 188.
732. SARAH ANN PARRY [EVANS] (John's great-granddaughter) was born in 1865, in Blaenpeak, Brilly Mountain, UK, to James EVANS⁷⁵³ and Sarah EVANS [LLOYD]⁷⁵², as shown in family tree 188.
733. WILLIAM JONES PARRY (John's great-granddaughter's husband).
William Jones PARRY married Sarah Ann PARRY [EVANS]⁷³², aged about 36, in 1901 in Hay, Brecknockshire.
Note: *Q2 (Marriage)*.

734. MARIANNE EVANS (John's great-granddaughter) was born in 1870, in Blaenpeak, Brilly Mountain, UK, to James EVANS⁷⁵³ and Sarah EVANS [LLOYD]⁷⁵², as shown in family tree 188.
735. ALBERT EVANS (John's great-granddaughter's husband).
Albert EVANS married Marianne EVANS⁷³⁴.

Generation of Grandchildren

736. JAMES LLOYD (John's grandson) was born to David LLOYD⁷⁵⁴, as shown in family tree 189.
737. JOHN LLOYD (John's grandson) was born in 1807, in Baynham Hall, to Hugh LLOYD⁷⁵⁵ and Ann LLOYD [DEAKINS (DAKIN)]⁷⁵⁶, as shown in family tree 190. He was christened on 22 November 1807. John died on 29 June 1870, aged about 62, in Michaelchurch.
Note: *Note 100.*
738. ANN LLOYD [MAINWARING] (John's grandson's wife) was born in 1801. See family tree 180. Ann died on 4 March 1862, aged about 60.
Note: *Note 101.*
John LLOYD⁷³⁷, aged about 35, married Ann LLOYD [MAINWARING], aged about 41, on 27 September 1842 in Michaelchurch. They had one son:
John LLOYD⁶⁶⁷ in 1842
This family is shown as family tree 180.
739. THOMAS LLOYD (John's grandson) was born in 1810, in Cascob, to Hugh LLOYD⁷⁵⁵ and Ann LLOYD [DEAKINS (DAKIN)]⁷⁵⁶, as shown in family tree 190. Thomas resided at Thomas LLOYD. Thomas died on 19 February 1880, aged about 69, in Empton Farm, UK. He was buried in Michaelchurch.
Note: *Note 102.*
- 
740. SOPHIA LLOYD (John's grandson's wife) was born in 1813, in Llansantffraed In Elwel. See family tree 181. Sophia resided at Sophia LLOYD. Sophia died on 30 May 1879, aged about 65. She was buried in Michaelchurch.
Note: *Note 103.*
Thomas LLOYD⁷³⁹ married Sophia LLOYD in Llansantffraed in Elwel. They had nine children:
Ann MEREDITH [LLOYD]⁶⁶⁸ in 1840
Thomas LLOYD⁶⁷⁰ in 1842
Mary LLOYD⁶⁷² in 1842
Hugh LLOYD⁶⁷³ in 1844
John LLOYD⁶⁷⁵ in 1846
Elizabeth (Bessie) JAMES [LLOYD]⁶⁷⁷ in 1847
William LLOYD⁶⁷⁹ in 1850
Evan LLOYD⁶⁸¹ in 1852
Sarah Sophia MORGAN [LLOYD]⁶⁸³ in 1857
The following information is also recorded for this family. Family Address, at Thomas and Sophia Lloyd.
This family is shown as family tree 181.
741. ANN DAVIES [LLOYD] (John's granddaughter) was born in 1813, in Cwm Mawr, Glascwm, to Hugh LLOYD⁷⁵⁵ and Ann LLOYD [DEAKINS (DAKIN)]⁷⁵⁶, as shown in family tree 190. Ann died on 28 February 1886, aged about 72.
742. JOHN DAVIES (John's granddaughter's husband) was born in 1805, in Newgate. See family tree 182. He was christened on 26 June 1805, in Glascwm. He was a Farmer Of New Buildings, Llandeilo Graban And Lower Gogia.
Note: *Note 104.*
John DAVIES, aged about 28, married Ann DAVIES [LLOYD]⁷⁴¹, aged about 20, on 1 August 1833 in Michaelchurch. They had six children:
John DAVIES⁶⁸⁵ in 1834
Thomas DAVIES⁶⁸⁶ in 1836
Anne DAVIES⁶⁸⁷ in 1839
Lloyd DAVIES⁶⁸⁸ in 1845
James DAVIES⁶⁸⁹ in 1847
Edward DAVIES⁶⁹⁰ in 1850
This family is shown as family tree 182.
743. MARY GRIFFITHS [LLOYD] (John's granddaughter) was born in 1815, in Glascwm, to Hugh LLOYD⁷⁵⁵ and Ann LLOYD [DEAKINS (DAKIN)]⁷⁵⁶, as shown in family tree 190. Mary died on 13 June 1900, aged about 84.
Note: *Note 105.*

744. JOHN GRIFFITHS (John's granddaughter's husband) was born in 1813. See family tree 183. John was a Farmer. John died on 18 June 1882, aged about 68. He was buried in Bryngwyn, Radnorshire, UK.
 Note: *Note 106.*
 John GRIFFITHS, aged about 23, married Mary GRIFFITHS [LLOYD]⁷⁴³, aged about 21, on 2 August 1836 in Michaelchurch. They had one son:
 Thomas GRIFFITHS⁶⁹¹ in 1843
This family is shown as family tree 183.
745. RICHARD LLOYD (John's grandson) was born in 1818, in Glaswcm, to Hugh LLOYD⁷⁵⁵ and Ann LLOYD [DEAKINS (DAKIN)]⁷⁵⁶, as shown in family tree 190. Richard died on 22 June 1869, aged about 50. He was buried in Michaelchurch.
 Note: *1851 Census (Birth).*
746. SARAH LLOYD [PROBERT] (John's grandson's wife) was born in 1820, in Llanbadarn Fawr. See family tree 184.
 Note: *1841 Census (Birth).*
 Richard LLOYD⁷⁴⁵ married Sarah LLOYD [PROBERT] in No record found. They had five children:
 Sarah Ann LLOYD⁶⁹³ in 1847
 Jeffrey Thomas LLOYD⁶⁹⁴ in 1849
 Richard LLOYD⁶⁹⁵ in 1854
 Mary Ann (Polly) FRANCIS [LLOYD]⁶⁹⁶ in 1857
 Annie PHILLIPS [LLOYD]⁶⁹⁸ in 1863
This family is shown as family tree 184.
747. WILLIAM LLOYD (John's grandson) was born in 1821, in Glaswcm, to Hugh LLOYD⁷⁵⁵ and Ann LLOYD [DEAKINS (DAKIN)]⁷⁵⁶, as shown in family tree 190. William was a Farmer Of 188 Acres Employing One Labourer - Thomas Harvard. William died on 11 June 1885, aged about 63. He was buried in Michaelchurch.
 Note: *Note 107.*
748. JANE LLOYD [GRIFFITHS] (John's grandson's wife) was born on 28 February 1819, in Llansantffraed in Elwel. See family tree 185. Jane died on 23 May 1885, aged 66. She was buried in Michaelchurch.
 William LLOYD⁷⁴⁷, aged about 34, married Jane LLOYD [GRIFFITHS], aged about 36, in 1855 in Kington. They had six sons:
 William LLOYD⁷⁰⁰ in 1855
 John LLOYD⁷⁰¹ in 1856
 James LLOYD⁷⁰³ in 1857
 Hugh LLOYD⁷⁰⁵ in 1858
 Thomas LLOYD⁷⁰⁷ in 1860
 Charles LLOYD⁷⁰⁸ in 1861
This family is shown as family tree 185.
 Note: *Q2 (Marriage).*
749. HUGH LLOYD (John's grandson) was born in 1823, in Glascombe, to Hugh LLOYD⁷⁵⁵ and Ann LLOYD [DEAKINS (DAKIN)]⁷⁵⁶, as shown in family tree 190. Hugh was a Bonesetter.
 Hugh married twice. He was married to Elizabeth LLOYD [LEWIS]⁷⁵⁰ and Sarah LLOYD [EVANS]⁷⁵¹.
 Note: *Note 108.*
750. ELIZABETH LLOYD [LEWIS] (John's grandson's wife) was born in 1828, in Dolbedwyn farm. See family tree 186.
 Elizabeth died in April 1848, aged about 19.
 Hugh LLOYD⁷⁴⁹, aged about 23, married Elizabeth LLOYD [LEWIS], aged about 18, in 1846 in Presteigne. They had one son:
 Hugh LLOYD⁷⁰⁹ in 1848
This family is shown as family tree 186.
 Note: *Q3 (Marriage).*
751. SARAH LLOYD [EVANS] (John's grandson's wife) was born in 1836, in Llanbedr Radnor. See family tree 187.
 Hugh LLOYD⁷⁴⁹, aged about 37, married Sarah LLOYD [EVANS], aged about 24, in 1860 in Hay. They had eleven children:
 John LLOYD⁷¹⁰ in 1846
 Thomas LLOYD⁷¹¹ in 1850
 Edward Lewis LLOYD⁷¹³ in 1853
 Mary LLOYD⁷¹⁵ in 1861
 William LLOYD⁷¹⁶ in 1865
 Evan LLOYD⁷¹⁷ in 1867
 Alice LLOYD⁷¹⁹ in 1869
 Price John LLOYD⁷²⁰ in 1871
 Sarah Ann LLOYD⁷²¹ in 1873
 Arthur LLOYD⁷²² in 1874
 Elizabeth MEREDITH [LLOYD]⁷²³ in 1876
This family is shown as family tree 187.

Note: *Q1 (Marriage)*.

752. SARAH EVANS [LLOYD] (John's granddaughter) was born in 1827, in Michaelchurch, to Hugh LLOYD⁷⁵⁵ and Ann LLOYD [DEAKINS (DAKIN)]⁷⁵⁶, as shown in family tree 190. Sarah died on 22 October 1914, aged about 87. She was buried in Rhos Goch.

Note: *Note 109*.

753. JAMES EVANS (John's granddaughter's husband) was born in 1815, in Pentwyn, Gladestry. See family tree 188. He was christened on 2 June 1815, in Llangunllo. He was a Farmer. James died on 8 September 1902, aged about 87. James was buried in Rhos Goch.

Note: *Note 110*.

James EVANS, aged about 32, married Sarah EVANS [LLOYD]⁷⁵², aged about 20, on 1 June 1848 in Michaelchurch.

They had nine children:

- James EVANS⁷²⁵ in 1848
- John EVANS⁷²⁶ in 1850
- Sarah Ann EVANS⁷²⁷ in 1852
- John EVANS⁷²⁸ in 1855
- Hugh Lloyd EVANS⁷²⁹ in 1858
- Thomas EVANS⁷³⁰ in 1861
- William EVANS⁷³¹ in 1863
- Sarah Ann PARRY [EVANS]⁷³² in 1865
- Marianne EVANS⁷³⁴ in 1870

This family is shown as family tree 188.

Generation of Children

754. DAVID LLOYD (John's son) was born on 9 September 1743, in Llandewi Ystradenny, to John LLOYD of Brunnant⁷⁶⁰ and Anne LLOYD [DAVIES]⁷⁶¹, as shown in family tree 191. David died on 5 May 1798, aged 54, in Llandewi Ystradenny.

David fathered one son:

- James LLOYD⁷³⁶

This family is shown as family tree 189.

755. HUGH LLOYD (John's son) was born in 1770, in Llandewi Ystradenny, to John LLOYD of Brunnant⁷⁶⁰ and Anne LLOYD [DAVIES]⁷⁶¹, as shown in family tree 191. He was christened on 20 January 1771, in Cwmmawr. He was a Bonesetter & Land Owner. He resided at Hugh LLOYD. Hugh died on 9 March 1856, aged about 85, in Baynham Hall. He was buried in Michaelchurch.

Note: *Note 111*.



756. ANN LLOYD [DEAKINS (DAKIN)] (John's daughter-in-law) was born in 1779, in Llangunllo. See family tree 190. Ann resided at Ann DEAKINS (DAKIN). Ann died on 11 August 1855, aged about 76, in Baynham Hall. She was buried in Michaelchurch.

Hugh LLOYD⁷⁵⁵, aged about 36, married Ann LLOYD [DEAKINS (DAKIN)], aged about 27, on 1 August 1806 in Llangunllo. They had eight children:

- John LLOYD⁷³⁷ in 1807
- Thomas LLOYD⁷³⁹ in 1810
- Ann DAVIES [LLOYD]⁷⁴¹ in 1813
- Mary GRIFFITHS [LLOYD]⁷⁴³ in 1815
- Richard LLOYD⁷⁴⁵ in 1818
- William LLOYD⁷⁴⁷ in 1821
- Hugh LLOYD⁷⁴⁹ in 1823
- Sarah EVANS [LLOYD]⁷⁵² in 1827

This family is shown as family tree 190.

Note: *By Banns (Marriage)*.

757. THOMAS LLOYD (John's son) was born on 1 May 1774, in Llandewi Ystradenny, to John LLOYD of Brunnant⁷⁶⁰ and Anne LLOYD [DAVIES]⁷⁶¹, as shown in family tree 191. Thomas died on 1 May 1818, aged 44, in Llandewi Ystradenny.

758. MARY LLOYD [BARKER] (John's daughter-in-law).

Thomas LLOYD⁷⁵⁷ married Mary LLOYD [BARKER].

759. JOHN LLOYD (John's nephew) was born on 17 March 1771 to Richard LLOYD⁷⁶⁴.

Generation of Peers

760. JOHN LLOYD OF BRUNNANT (The subject of this report) was born in 1725 to John LLOYD⁷⁶⁶ and Jane LLOYD⁷⁶⁷, as shown in family tree 192. John died on 28 November 1789, aged about 64, in Llandewi Ystradenny.

Note: *Note 112.*

761. ANNE LLOYD [DAVIES] (John's wife). See family tree 191. Anne died on 20 October 1784 in Llandewi Ystradenny. John LLOYD of Brunnant⁷⁶⁰, aged about 15, married Anne LLOYD [DAVIES] on 9 January 1741 in Llandewi Ystradenny. They had three sons:

David LLOYD⁷⁵⁴ in 1743

Hugh LLOYD⁷⁵⁵ in 1770

Thomas LLOYD⁷⁵⁷ in 1774

This family is shown as family tree 191.

762. THOMAS LLOYD (John's brother) was born to John LLOYD⁷⁶⁶ and Jane LLOYD⁷⁶⁷, as shown in family tree 192.

763. HESTER LLOYD (John's sister-in-law).

Thomas LLOYD⁷⁶² married Hester LLOYD on 7 January 1743 in Llandewi Ystradenny.

764. RICHARD LLOYD (John's brother) was born to John LLOYD⁷⁶⁶ and Jane LLOYD⁷⁶⁷, as shown in family tree 192.

Note: *Note 113.*

Richard fathered one son:

John LLOYD⁷⁵⁹ in 1771

765. HESTER LLOYD (John's sister) was born to John LLOYD⁷⁶⁶ and Jane LLOYD⁷⁶⁷, as shown in family tree 192.

Generation of Parents

766. JOHN LLOYD (John's father) was born in 1680. See family tree 192. John died on 9 June 1740, aged about 59.

767. JANE LLOYD (John's mother). See family tree 192. Jane died on 13 April 1761.

John LLOYD⁷⁶⁶ married Jane LLOYD. They had four children:

John LLOYD of Brunnant⁷⁶⁰ in 1725

Thomas LLOYD⁷⁶²

Richard LLOYD⁷⁶⁴

Hester LLOYD⁷⁶⁵

This family is shown as family tree 192.

3. FAMILY TREES

Each family tree shows the reported children, parents, grandparents and great-grandparents of a family group. In order to reduce redundancy, any family group which is wholly included within another family tree may not be reported separately.

Above each of the great-grandparent boxes (top row), a continuation family tree reference number is shown if the great-grandparent is recorded as a child in the continuation tree. A continuation reference number is also shown to the left of a grandparent or parent box if that individual has siblings reported in the continuation tree; and beneath a child box (bottom row) if that individual has children reported in the continuation tree.

In cases of multiple marriages, a continuation reference number preceded by "=" is shown to the right of a parent box. This number references the previous and/or next tree in which that individual is shown with another partner.

In cases of adopted (or fostered) children, the parental connection is shown with a dashed line and a continuation reference number preceded by "=" is shown within the individual's box. This number references the tree in which that individual is shown with his or her natural parents.

1. BYWATER, Richard Mathew and BYWATER [PRIEST], Susan
2. STEPHENS, Peter j and STEPHENS [BYWATER], Olivia
3. BYWATER, Sebastian and BYWATER [ANDERSON], Caroline
4. WEBB, Alan and WEBB, Ms.
5. ROBERTS, Andrew William
6. ROBERTS, Andrew William
7. BOWERS, Stewart and BOWERS [BROWN], Jeanne
8. BROWN, Carol
9. LEWIS, Mr. and LEWIS [BROWN], Alison
10. BROWN, Wynn and BROWN [BAGLEY], Margaret
11. BROWN, Nigel
12. DORWOOD, Mr. and DORWOOD [BROWN], Claire
13. EVANS, Gareth and EVANS [STEPHENS], Lowri Angharad
14. DAY, Geraint and DAY [STEPHENS], Heledd Melangell
15. EVANS, Aron and EVANS [STEPHENS], Brengain Gwennllian
16. CORRIE, Clive and CORRIE [STEPHENS], Sian
17. STEPHENS, Neil and STEPHENS, Alison
18. PRITCHETT, Bruce and PRITCHETT, Jane
19. BACE, Gordon and BACE [PRITCHETT], Jill
20. BOWS, Laura Anne
21. UNKNOWN, Mr. and WILLIAMS, Leslie
22. WILLIAMS, Michael and WILLIAMS, Ms.
23. UNKNOWN, Mr. and WILLIAMS, Lynette
24. AWAAD, Mohammed Osman M and AWAAD [FARMER], Theresa Louise
25. FARMER, Adrian Oliver and FARMER [TITLEY], Jane
26. NEWTON, Amanda Louise
27. BOUNDS ?, Stephen and BOUNDS ? [LEWIS], Kerry
28. BYWATER, Richard David and BYWATER [MARTIN], Joan S
29. LEWIS, Gordon G and LEWIS [BYWATER], Margaret
30. BYWATER, John and BYWATER, Louise
31. JAMES, Jeff and JAMES [BYWATER], Ruth
32. BYWATER, Robin, BVMS, PhD and BYWATER [SCOTT], May
33. PRICE, Russell and PRICE [BYWATER], Sally
34. BYWATER, John and BYWATER [JONES], Kate
35. THOMAS, Roger and THOMAS [BYWATER], Rosemary
36. MORRIS, Richard and MORRIS [EVANS], Vivien
37. BYWATER, Murray Lloyd and BYWATER, Pamela
38. CLIFFORD, Peter and CLIFFORD [BYWATER], Judith Lloyd
39. BYWATER, Richard Lloyd and BYWATER, Linda
40. BYWATER, John and BYWATER [COXON], Sue
41. HARRIS, Edward and HARRIS, Margaret
42. HARRIS, Thomas L and HARRIS [JONES], Kathleen M
43. DAVIES, Charles and DAVIES, Ms.
44. GRIFFITHS, Mr. and GRIFFITHS [DAVIES], Julie
45. WHATELEY, Dr Tony and ROBERTS, Maisie Annie
46. WEBB, David and WEBB [ROBERTS], Elizabeth Mary (Betty)
47. ROBERTS, Newton
48. ROBERTS, Caleb Thomas
49. BROWN, Derek and LLOYD, Muriel Doreen
50. STEPHENS, Meic, MA Dllit and STEPHENS [MEREDITH], Ruth Wynn
51. STEPHENS, Lloyd and STEPHENS [MORRIS], Margaret Patricia Ismay

52. PRITCHETT, Aubrey E Michael and PRITCHETT [BEASLEY], Janet
53. LANE, Philip and LANE, Susan
54. LLOYD, David Philip John, CEng, CITP, MBCS., MAPM and LLOYD [BUBEAR], Maria Alexandra, RGN RMN
55. LLOYD, Peter Geoffrey and LLOYD [DAWE], Karen Margaret
56. LLOYD, Andrew Robert, RAF and LLOYD [DUGGAN], Cheryl Esther
57. LEWIS, Robin and LEWIS [BOWS], Kathryn Ann, BMedSci , BM, BS
58. BOWS, Richard, RAF (Retd) and BOWS [EASTWOOD], Terri
59. LLOYD, Stephen Gareth, BSc, D.C and LLOYD [DENMAN], Juliet, Grad Dip TH
60. LLOYD, Peter Adrian and LLOYD [FOLEY], Catherine
61. EARTHROWL, David and STRATTON, Bronwen Dorothy
62. LEWIS, Christopher Illtyd and LEWIS [ROBERTS-LEWIS], Janet
63. JONES, John and JONES [MORGAN], Sandra
64. JONES, Robert and JONES [EVANS], Nicola
65. BLANDFORD, Timothy and BLANDFORD [JONES], Ann
66. HARRISON, Karl and HARRISON [POWELL], Jane
67. TUFT, Stephen and TUFT [POWELL], Clare
68. WILLIAMS, Kenneth (Ken) and WILLIAMS, Vera Lindsley
69. WILLIAMS, Glyn and WILLIAMS [WATKINS], Dilys
70. FARMER, Herbert Oliver and FARMER [JAMES], Rita Hazel
71. MORGAN, Winston Barrie and MORGAN [TAYLOR], Nancy C
72. NEWTON, Roger John and NEWTON [LLOYD], Elizabeth Anne
73. LLOYD, David Evan and LLOYD [DURRELL], Irene
74. LLOYD, Graham C and LLOYD [WILLIAMS], Wendy
75. SKYRME, Richard Philip and SKYRME [POWELL], Anita Jane
76. WILLIAMS, Christopher John and WILLIAMS [POWELL], Kathryn Ann
77. LLOYD, Alan Hugh and LLOYD [GOUGH], Sarah Marie
78. LLOYD, Elwyn John and LLOYD [HYATT], Jane
79. PHILLIPS, Ian and PHILLIPS [SPAREY], Pamela
80. PHILLIPS, Colin and PHILLIPS [EDWARDS], Jane
81. LEWIS, John H and LEWIS [PRICE], Lorraine
82. WILLIAMS, David and WILLIAMS [PRICE], Dawn
83. BYWATER, Richard and BYWATER [THOMAS], Mary Elizabeth
84. BYWATER, Richard and BYWATER [ELLIS], Phyllis
85. BYWATER, Caleb James and BYWATER [WATKINS], Doris
86. BYWATER, John (aka Jack) and BYWATER [DAVIES], Edith
87. MORRIS, Ira, RAF and MORRIS [BYWATER], Naomi
88. BYWATER, Thomas and BYWATER [MCLELLAN MILLAR], Ishobel
89. BYWATER, Robert David and BYWATER [NOTT], Mary
90. HARRIS, Edward and HARRIS [BYWATER], Joyce Sarah
91. DAVIES, Trevor Glyn and DAVIES [BYWATER], Constance Minnie
92. ROBERTS, William Thomas and ROBERTS [MASON], Doris
93. ROBERTS, James Albert and ROBERTS [WILLIAMS], Annie
94. ROBERTS, William Caleb and ROBERTS [PLAIN], Mona A
95. LLOYD, Muriel Annie (Dolly)
96. PICKERSGILL, Mr. and PICKERSGILL [LLOYD], Gwendoline Dilys
97. TAIT, Mr. and TAIT [LLOYD], Kathleen Florence Martha
98. HARRIS, Mr. and HARRIS [LLOYD], Margaret Maisie
99. DAVIES, Mr. and DAVIES [LLOYD], Mercia Willoughby
100. LLOYD - STEPHENS, Herbert Arthur and LLOYD - STEPHENS [SYMES], Alma
101. PRITCHETT, Aubrey and PRITCHETT [EVES], Annie Matilda (Nan)
102. LANE, Tom Evan and LANE [BALLINGER], Irene
103. LLOYD, John and LLOYD [MILLER], Beryl Kathryn
104. BOWS, Raymond George (Bill), BA and BOWS [LLOYD], Annie Mabel (Nancy), BA
105. LLOYD, David Kingsley and LLOYD [MURRAY], Susan M
106. HARDWICK, Tom and HARDWICK [LLOYD], Kathleen
107. LLOYD, Sidney Walter Gordon and LLOYD [SIMMONS], Peggy
108. STRATTON, John Arthur and STRATTON [MACAULAY], Hannah Heslop
109. ROBERTS, Robert Owen and ROBERTS [STRATTON], Edith Megan
110. JONES, Harold Henry and JONES [POWELL], Dorothy May
111. INGRAM, George James and INGRAM [POWELL], Gwendoline Jane (Babs)
112. POWELL, Thomas John and POWELL [GORE], Enid
113. PRICE, William Mervyn and PRICE [POWELL], Elizabeth Rachel
114. POWELL, Kenneth Charles and POWELL [PUGH], Ruth
115. DAVIES, Jeffrey and DAVIES [POWELL], Edith Margaret
116. POWELL, Eithel Pugh and POWELL, Lena Mary

117. BOWEN, Gilbert Samuel and BOWEN [POWELL], Jeanette
118. POWELL, William Owen and POWELL [LLOYD], Mary
119. POWELL, Robert Lloyd and POWELL [LEWIS], Christine
120. ILES, Derek and ILES [POWELL], Ms.
121. WILLIAMS, Sid and WILLIAMS [JAMES], Phyllis
122. UNKNOWN, Mr. and JAMES, Mary
123. LEWIS, David and JAMES, Mary
124. MORGAN, Thomas A and MORGAN [JAMES], Margeurite J
125. LLOYD, Walter and LLOYD [DAVIES], Dorothy Clare
126. DUGGAN, John (Jack) E and DUGGAN [LLOYD], Emily Maud
127. LLOYD, Evan Rice and LLOYD, Hilda
128. LLOYD, Henry Charles and LLOYD [BAKER], Enid A
129. POWELL, David and POWELL [LLOYD], Joan
130. LLOYD, Hugh and LLOYD [MORRIS], Eva Grace
131. PHILLIPS, Victor Evan and PHILLIPS [LLOYD], Doris
132. LEWIS, John and LEWIS [LLOYD], Elizabeth Nancy
133. PRICE, Edward and PRICE [LLOYD], Margaret
134. DREW, Edmund Danzey and DREW [LLOYD], Margaret
135. WILLIAMS, William and WILLIAMS [LLOYD], Mary Ann (Polly)
136. BYWATER, Richard and BYWATER [LLOYD], Sarah Rosa
137. ROBERTS, William Owen and ROBERTS [LLOYD], Ann Sophia
138. LLOYD, Hugh and LLOYD [HARLEY], Florence
139. LLOYD, Hugh and LLOYD [WILLOUGHBY], Emily Elizabeth
140. UNKNOWN, Mr. and LLOYD, Annie Sophia (aka Nancy)
141. EVES, Ernest Edward and EVES [LLOYD], Sophia Matilda (Tillie)
142. LANE, Thomas and LANE [LLOYD], Elizabeth Anne (Annie)
143. LLOYD, Hugh and LLOYD [KINGS], Laura
144. LLOYD, Thomas John and LLOYD [JONES], Catherine
145. LLOYD, Evan Sidney and LLOYD [KINGS], Mabel
146. STRATTON, Arthur and STRATTON [LLOYD], Sarah Janet
147. PUGH, David and PUGH [GRIFFITHS], Eva
148. GRIFFITHS, Thomas Clement J and PEVERILL, Blanche
149. GRIFFITHS, Arthur and GRIFFITHS [EVANS], Maud
150. WHITTALL, Ivor and WHITTALL [LLOYD], Gwendoline Gertrude
151. POWELL, Thomas John and POWELL [LLOYD], Jane Sophia
152. POWELL, William Baden and POWELL [LLOYD], Edith Mary
153. JAMES, Henry (Harold) and JAMES [LLOYD], Sarah Jane (Janey)
154. LLOYD, Thomas and LLOYD [PRITCHARD], Margaret Jane
155. LLOYD, James and LLOYD [HAMER], Sarah Ann
156. LLOYD, Charles and LLOYD [EVANS], Lily May (aka Doris)
157. LLOYD, Hugh and LLOYD [EDITH], Frances
158. LLOYD, Danzey Evan and LLOYD [JONES], Gertrude
159. LLOYD, Hugh and LLOYD [GODWIN], Susannah
160. LLOYD, James and LLOYD [PHILLIPS], Anne
161. LLOYD, Thomas Hugh and LLOYD [CLARKE], Eva May
162. LLOYD, Thomas Hugh and LLOYD [LEWIS], Beatrice Eva
163. MEREDITH, Samuel and MEREDITH [LLOYD], Ann
164. LLOYD, Thomas and LLOYD [CONNOP], Margaret
165. LLOYD, Hugh and LLOYD [POWELL], Martha
166. LLOYD, John and LLOYD [DAVIES], Mary Ann
167. JAMES, James and JAMES [LLOYD], Elizabeth (Bessie)
168. LLOYD, William and LLOYD [MILWARD], Sarah
169. LLOYD, Evan and LLOYD [HILL], Clara
170. MORGAN, William and MORGAN [LLOYD], Sarah Sophia
171. GRIFFITHS, Thomas and GRIFFITHS [DAVIES], Fortune
172. LLOYD, Sarah Ann
173. LLOYD, John and LLOYD [REES], Rachel
174. LLOYD, James and LLOYD [DREW], Harriett
175. LLOYD, Hugh and LLOYD [REES], Margaret
176. LLOYD, Thomas and LLOYD [HARVARD], Sarah Ann
177. LLOYD, Edward Lewis and LLOYD [POWELL], Catherine
178. LLOYD, Evan and LLOYD [BOND], Emma Eliza
179. MEREDITH, David Thomas and MEREDITH [LLOYD], Elizabeth
180. LLOYD, John and LLOYD [MAINWARING], Ann
181. LLOYD, Thomas and LLOYD, Sophia
182. DAVIES, John and DAVIES [LLOYD], Ann

183. GRIFFITHS, John and GRIFFITHS [LLOYD], Mary
184. LLOYD, Richard and LLOYD [PROBERT], Sarah
185. LLOYD, William and LLOYD [GRIFFITHS], Jane
186. LLOYD, Hugh and LLOYD [LEWIS], Elizabeth
187. LLOYD, Hugh and LLOYD [EVANS], Sarah
188. EVANS, James and EVANS [LLOYD], Sarah
189. LLOYD, David
190. LLOYD, Hugh and LLOYD [DEAKINS (DAKIN)], Ann
191. LLOYD, John, of Brunnant and LLOYD [DAVIES], Anne
192. LLOYD, John and LLOYD, Jane

1. Richard Mathew BYWATER and Susan BYWATER [PRIEST]

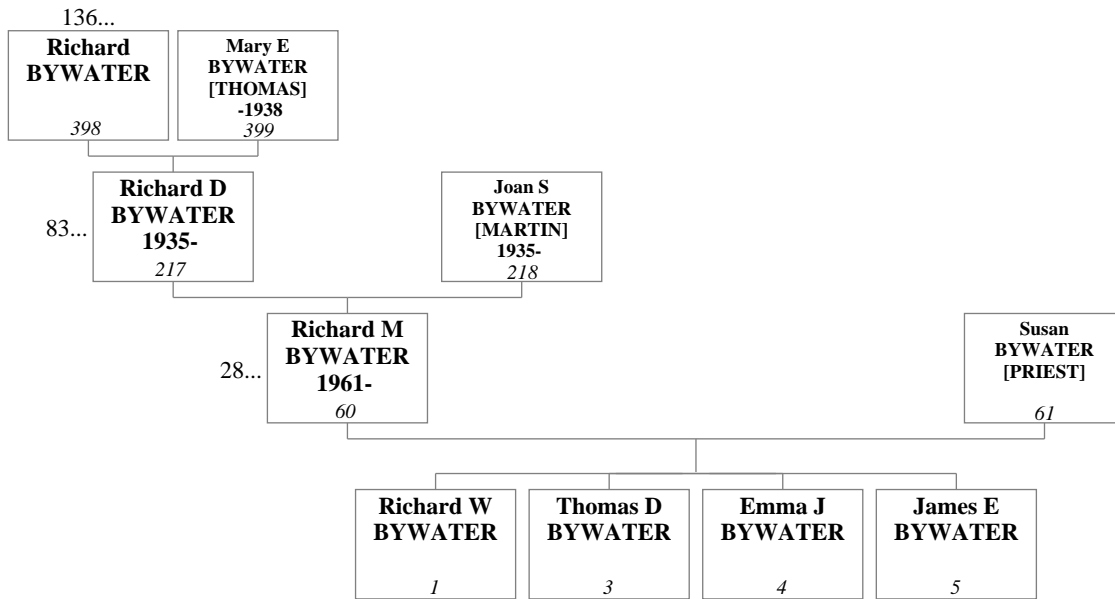

2. Peter j STEPHENS and Olivia STEPHENS [BYWATER]

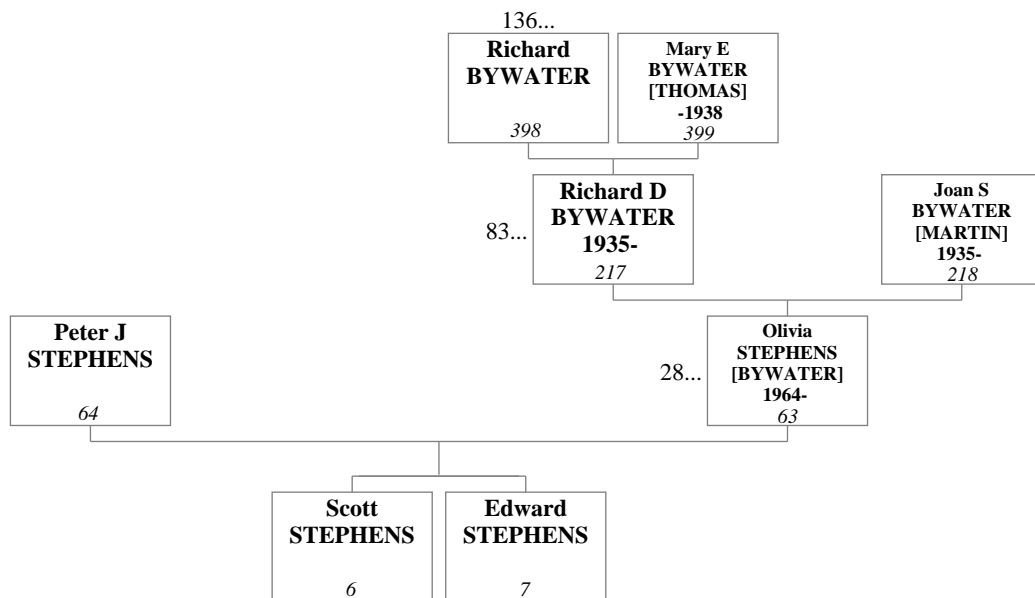

3. Sebastian BYWATER and Caroline BYWATER [ANDERSON]

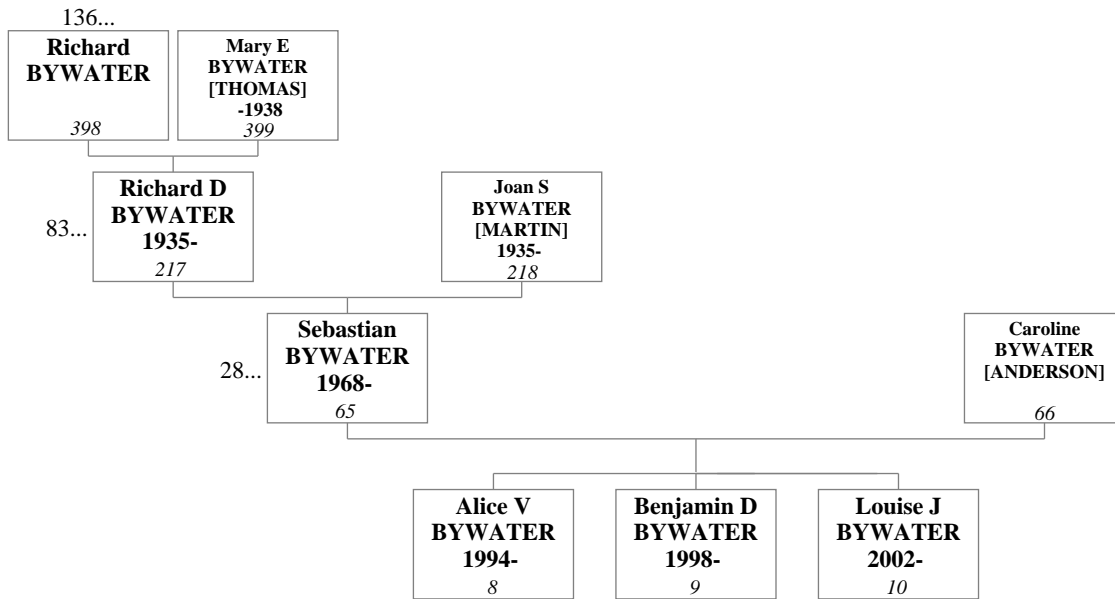

4. Alan WEBB and Ms. WEBB

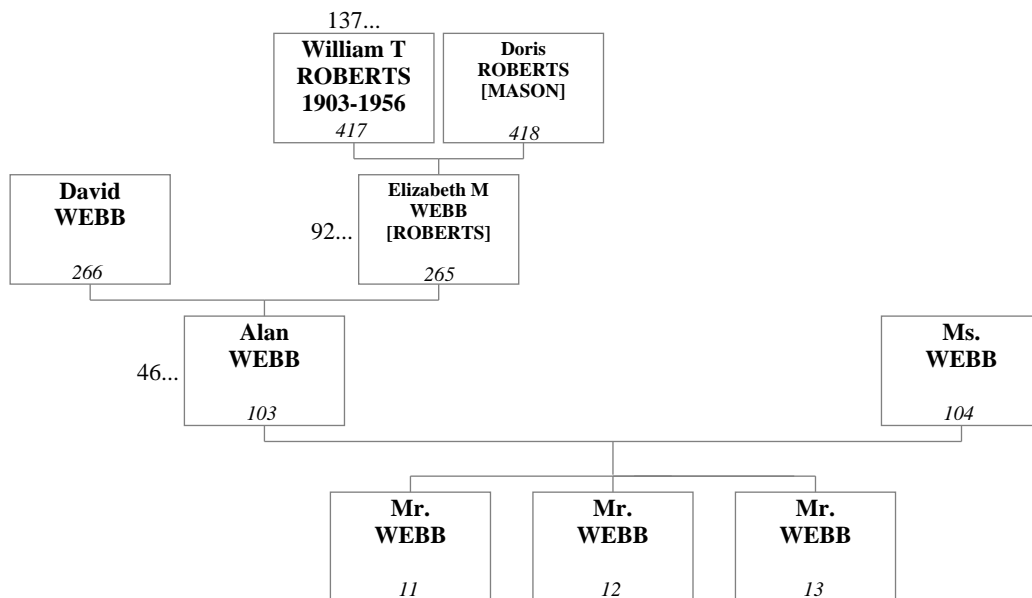

5. Andrew William ROBERTS

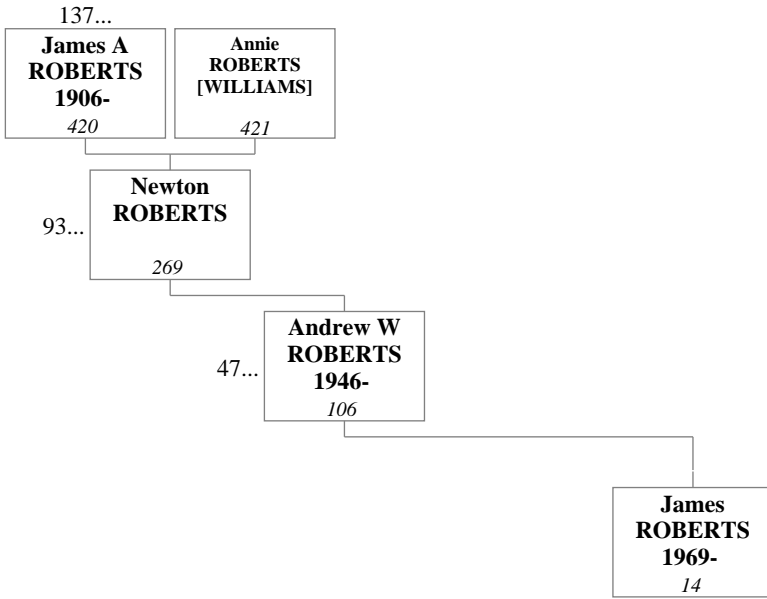

6. Andrew William ROBERTS

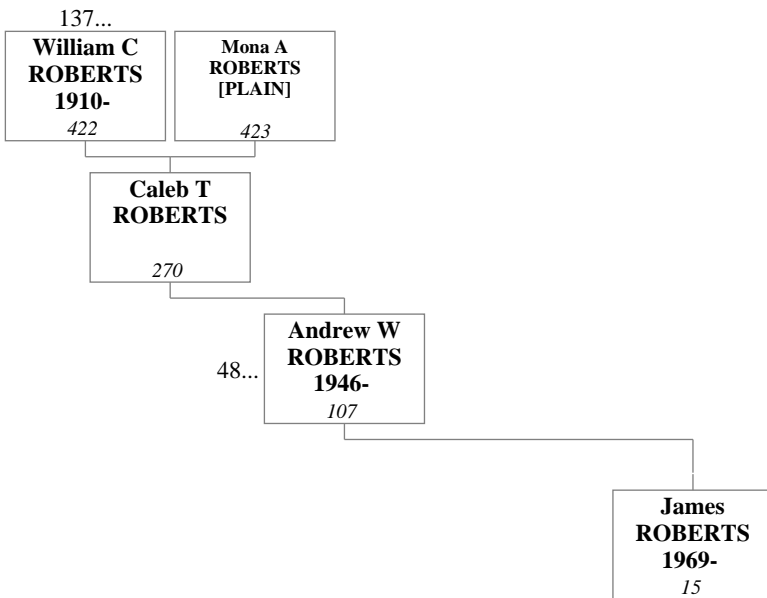

7. Stewart BOWERS and Jeanne BOWERS [BROWN]

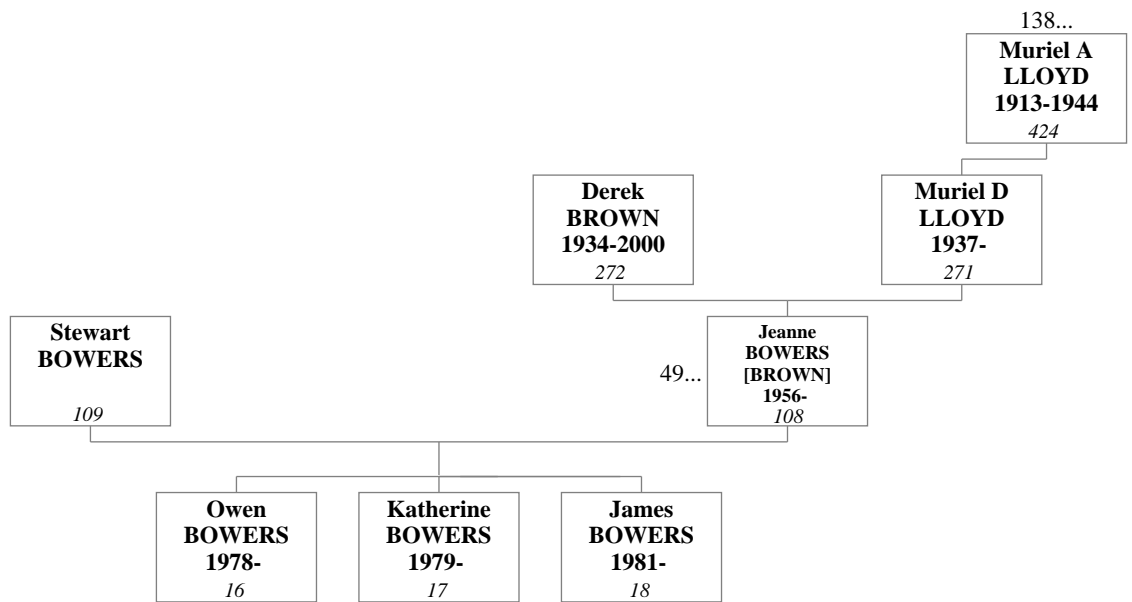

8. Carol BROWN

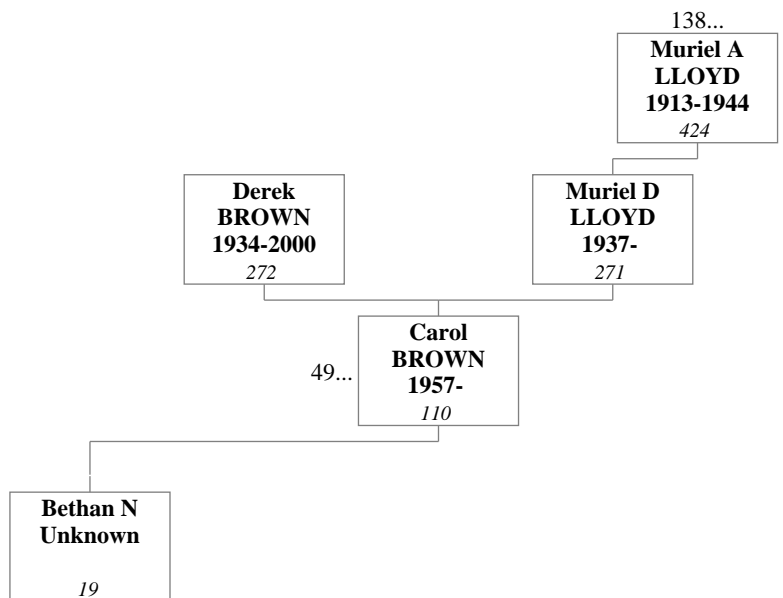

9. Mr. LEWIS and Alison LEWIS [BROWN]

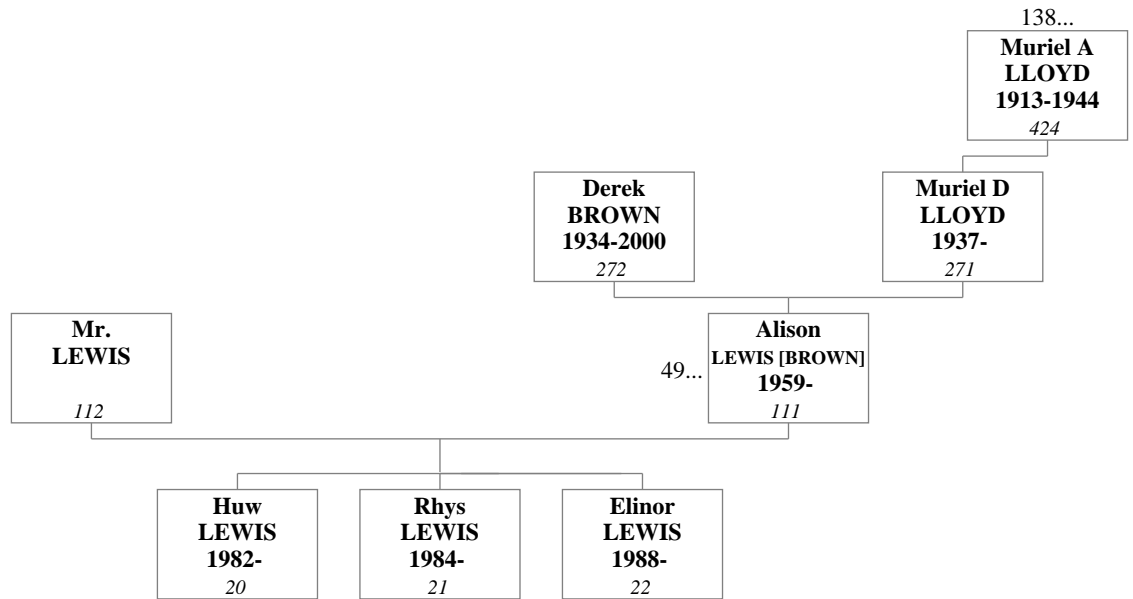

10. Wynn BROWN and Margaret BROWN [BAGLEY]

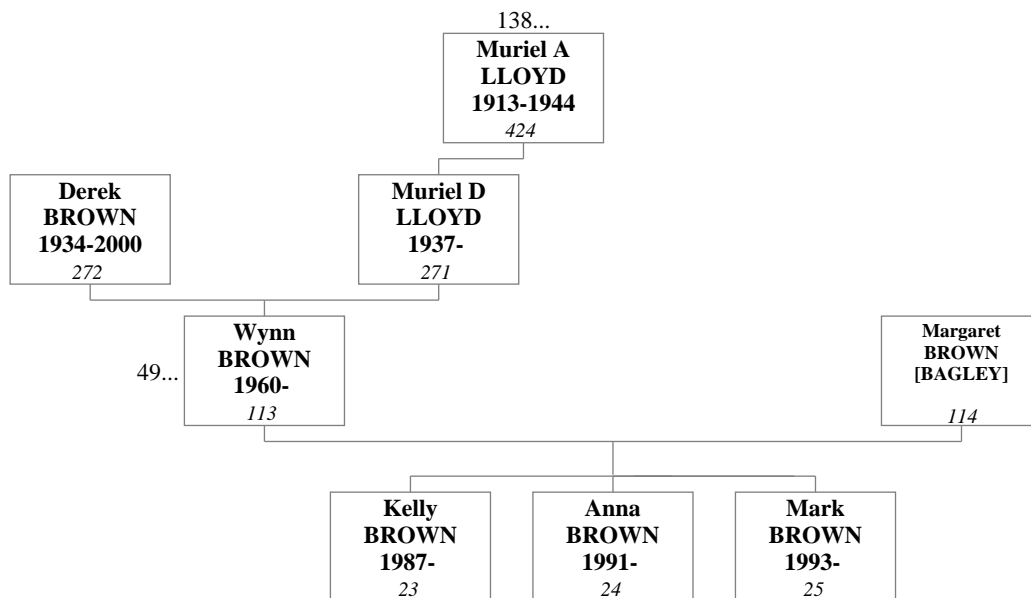

11. Nigel BROWN

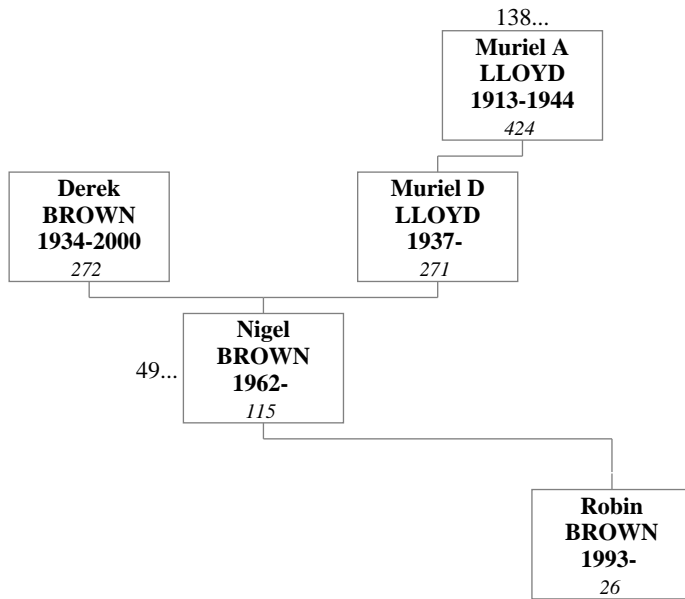

12. Mr. DORWOOD and Claire DORWOOD [BROWN]

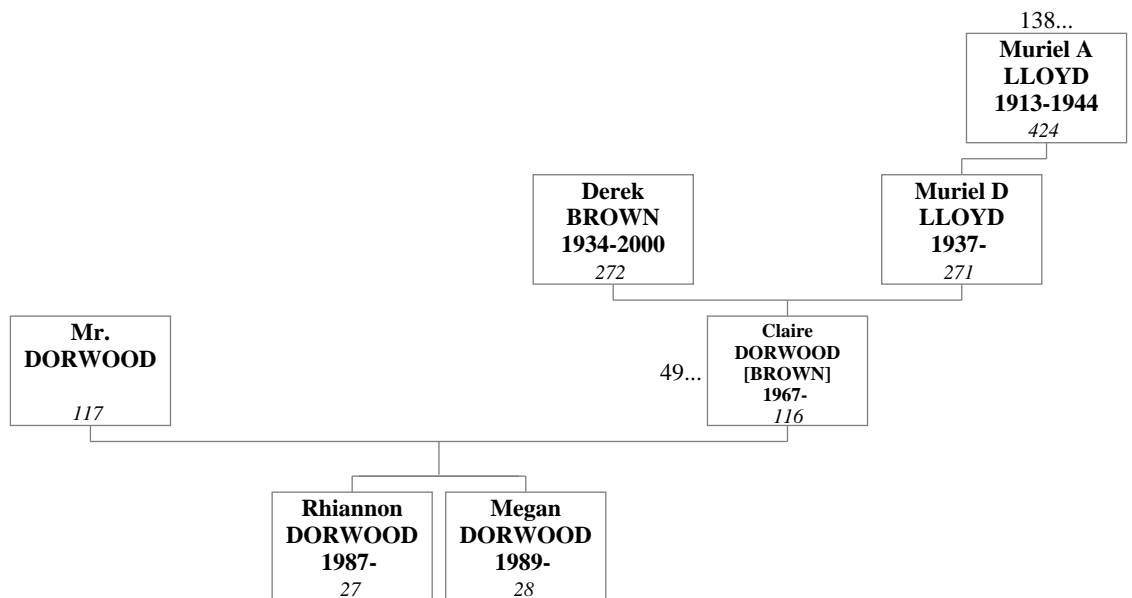

13. Gareth EVANS and Lowri Angharad EVANS [STEPHENS]

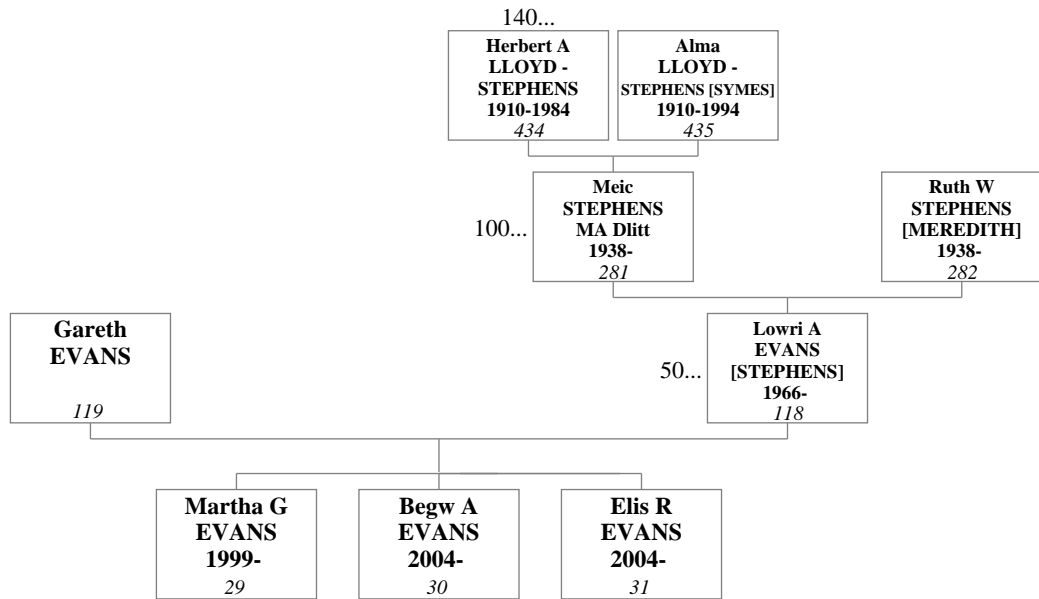

14. Geraint DAY and Heledd Melangell DAY [STEPHENS]

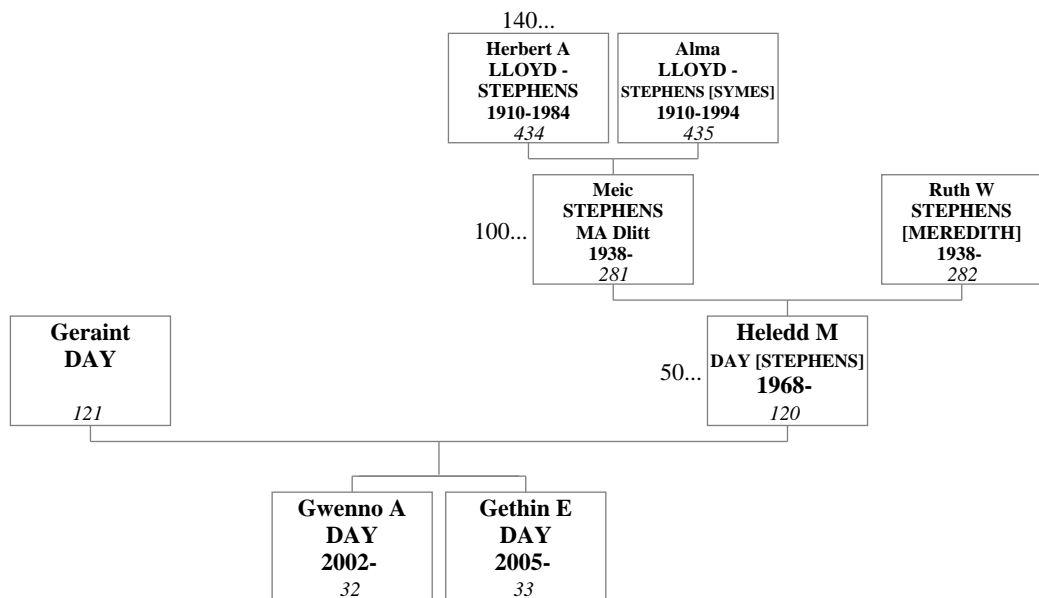

15. Aron EVANS and Brengain Gwenllian EVANS [STEPHENS]

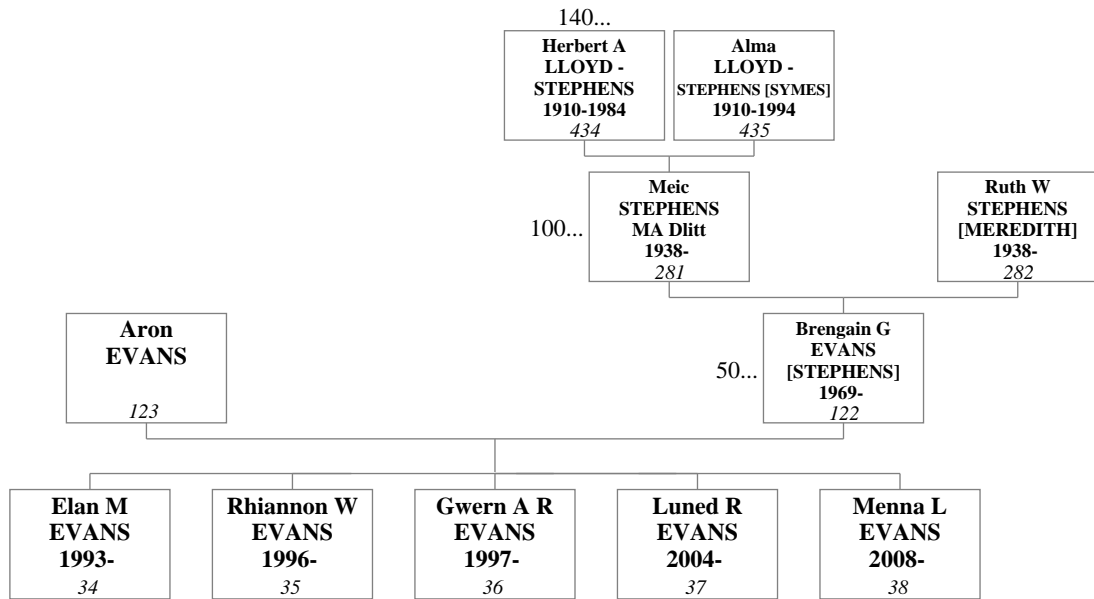

16. Clive CORRIE and Sian CORRIE [STEPHENS]

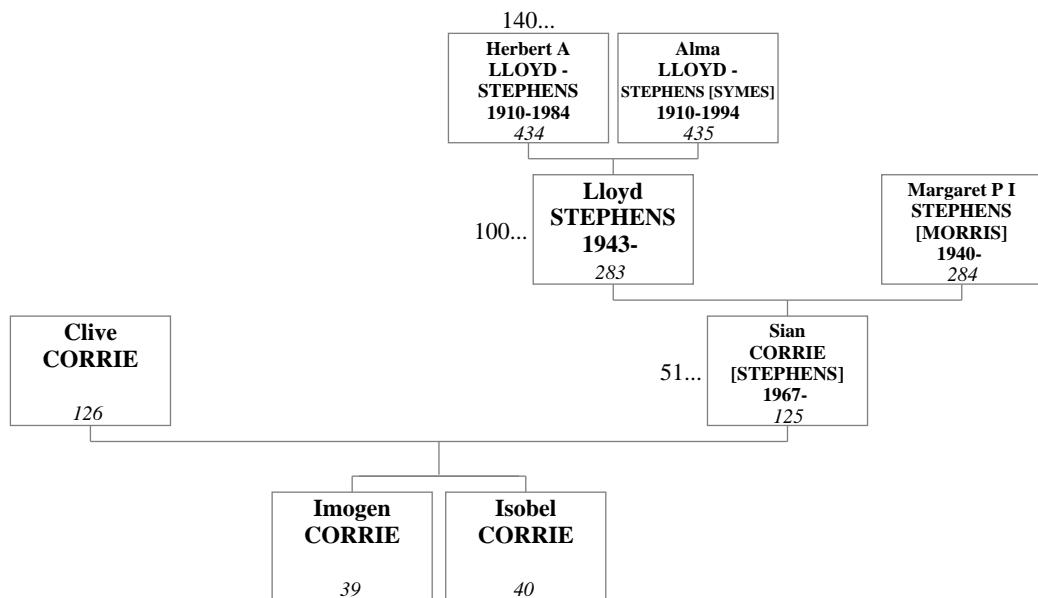

17. Neil STEPHENS and Alison STEPHENS

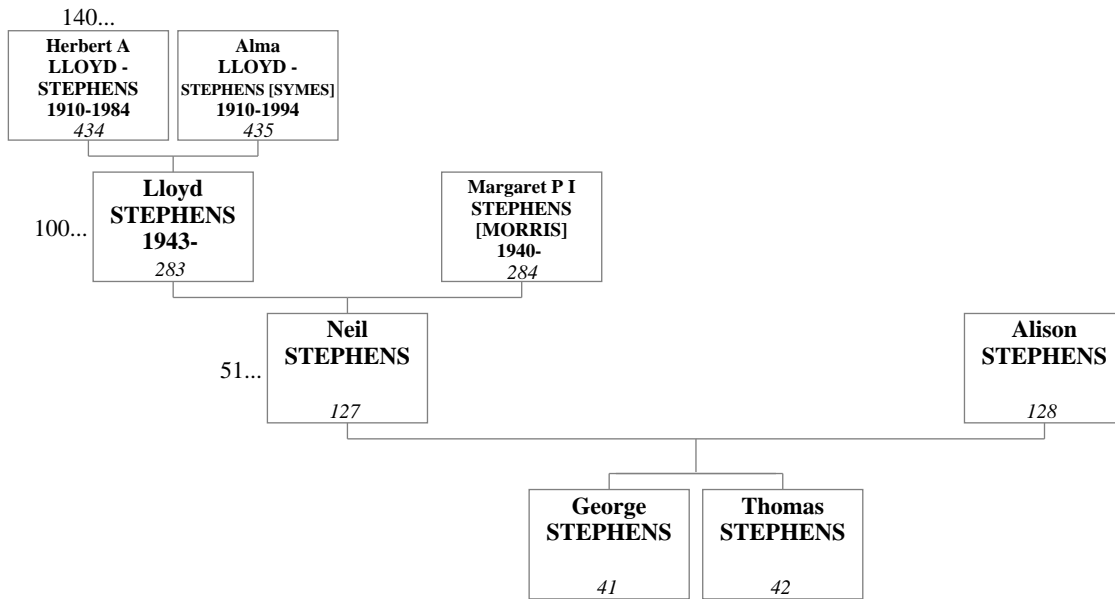

18. Bruce PRITCHETT and Jane PRITCHETT

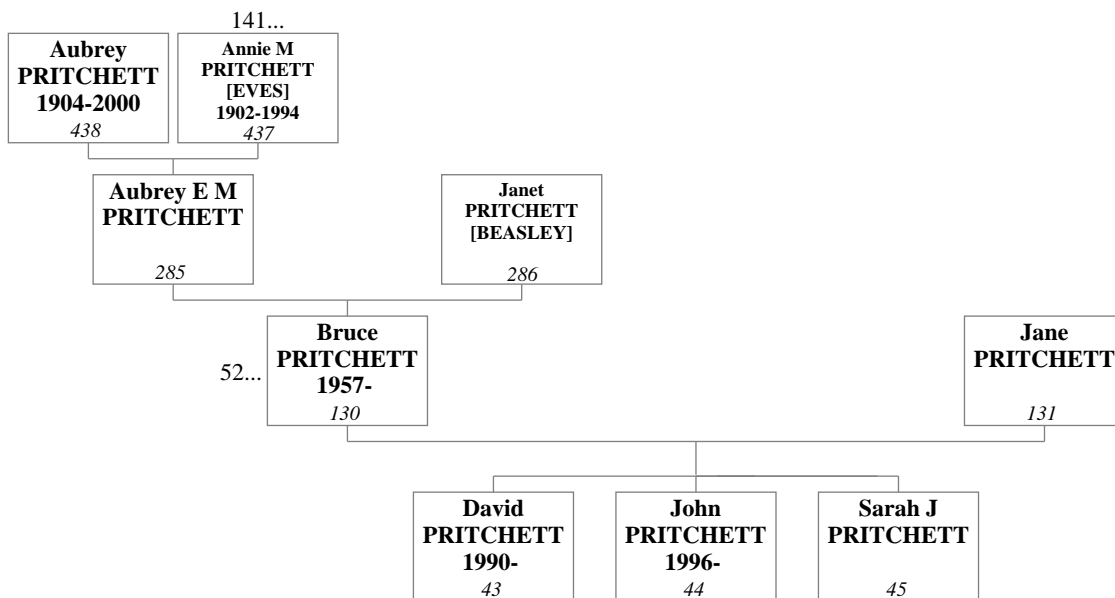

19. Gordon BACE and Jill BACE [PRITCHETT]

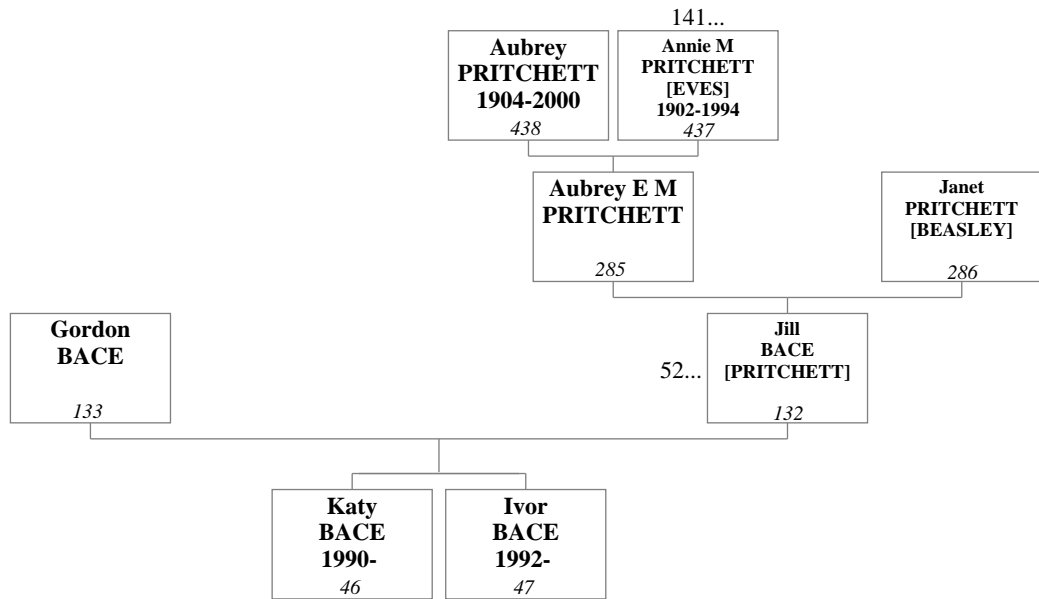

20. Laura Anne BOWS

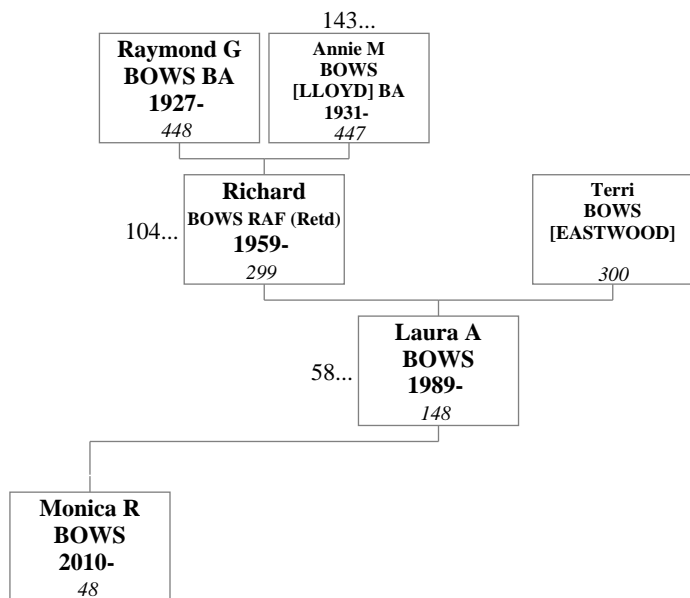

21. Mr. Unknown and Leslie WILLIAMS

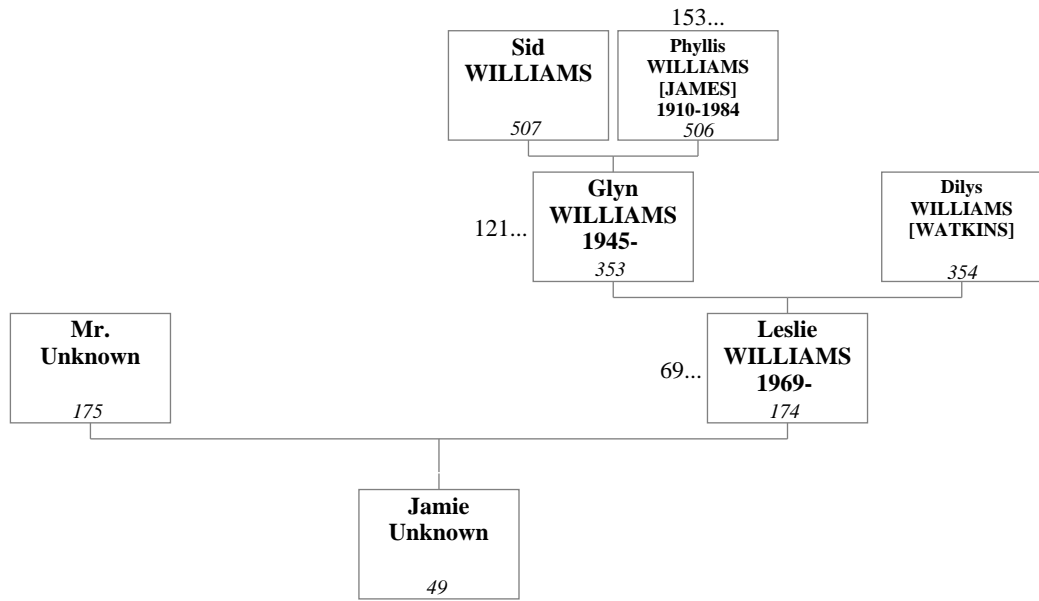

22. Michael WILLIAMS and Ms. WILLIAMS

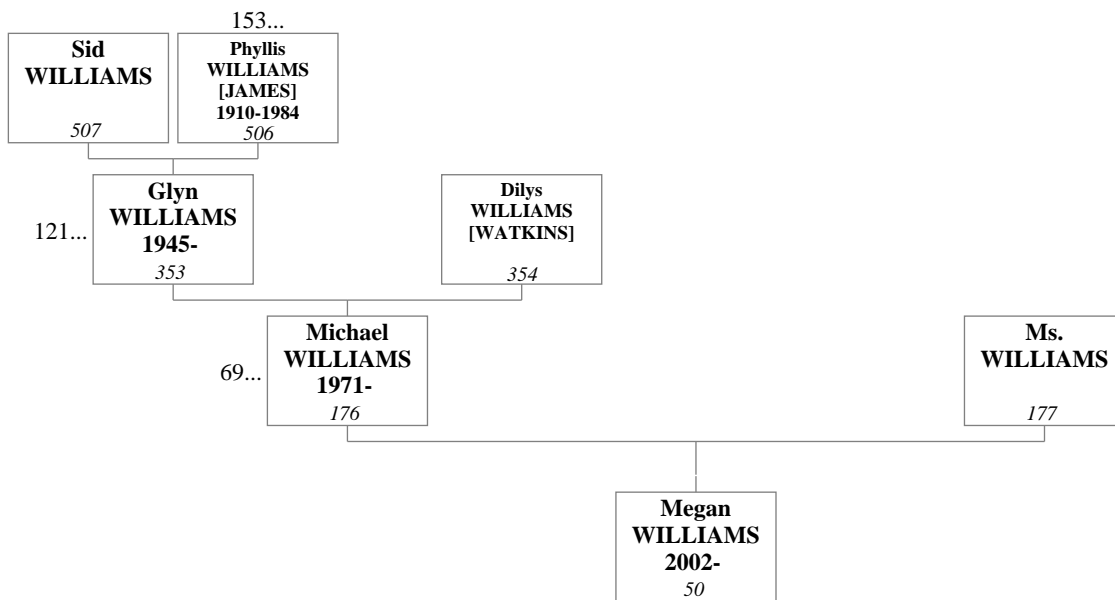

23. Mr. Unknown and Lynette WILLIAMS

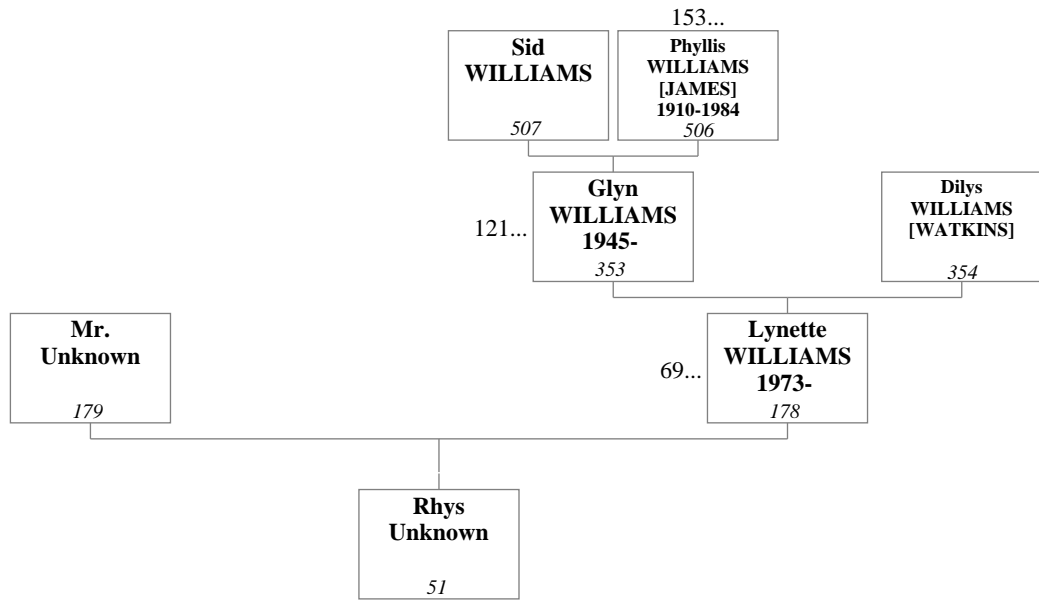

24. Mohammed Osman M AWAAD and Theresa Louise AWAAD [FARMER]

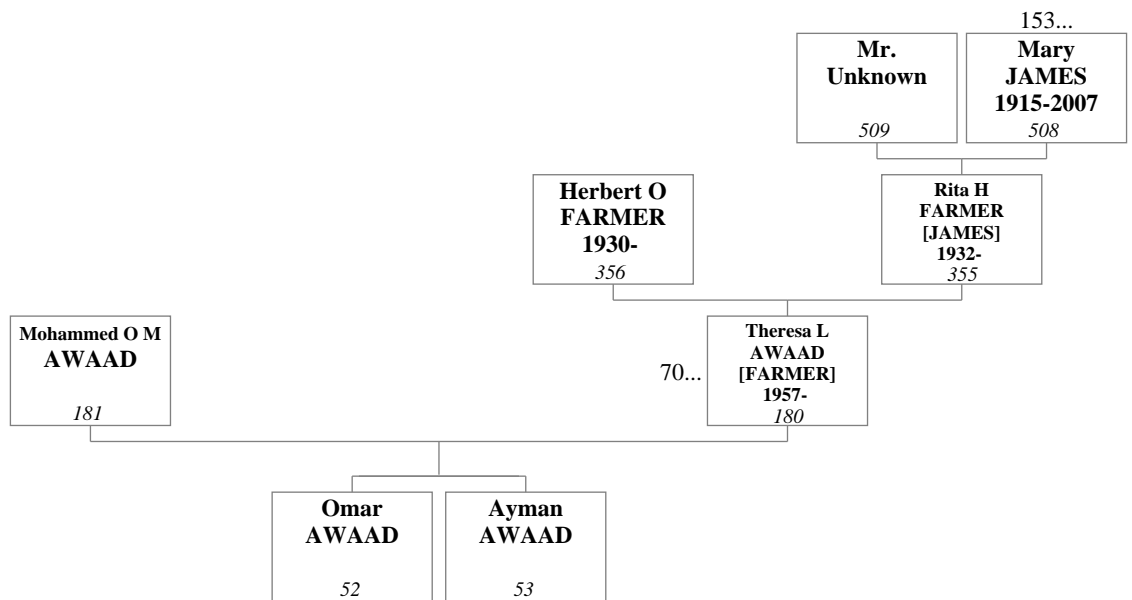

25. Adrian Oliver FARMER and Jane FARMER [TITLEY]

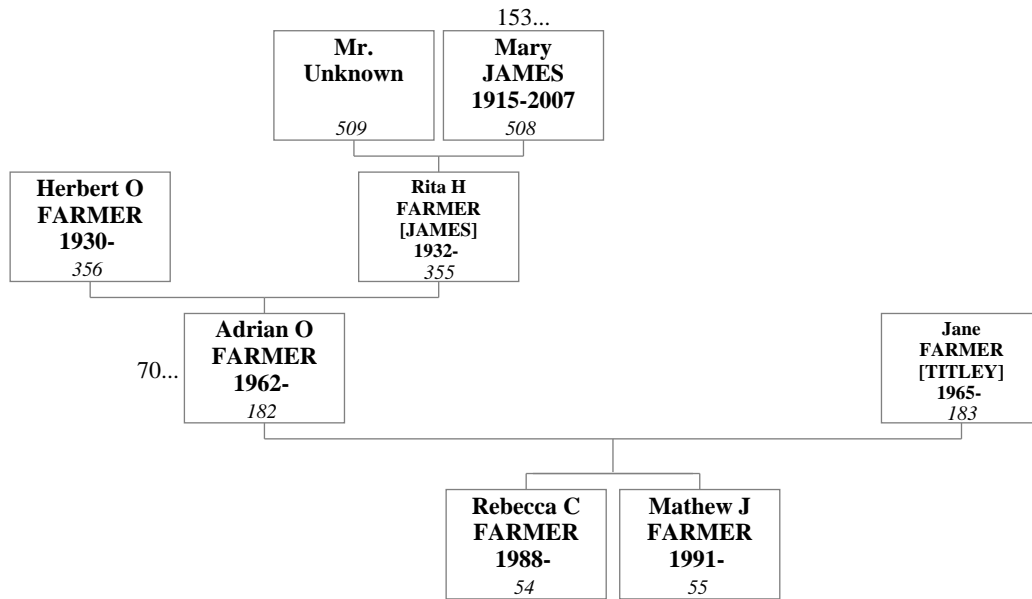

26. Amanda Louise NEWTON

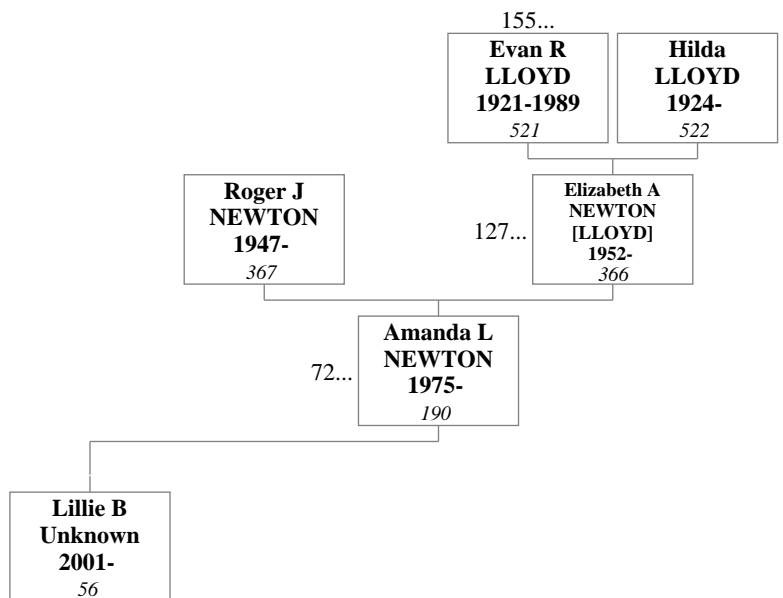

27. Stephen BOUNDS ? and Kerry BOUNDS ? [LEWIS]

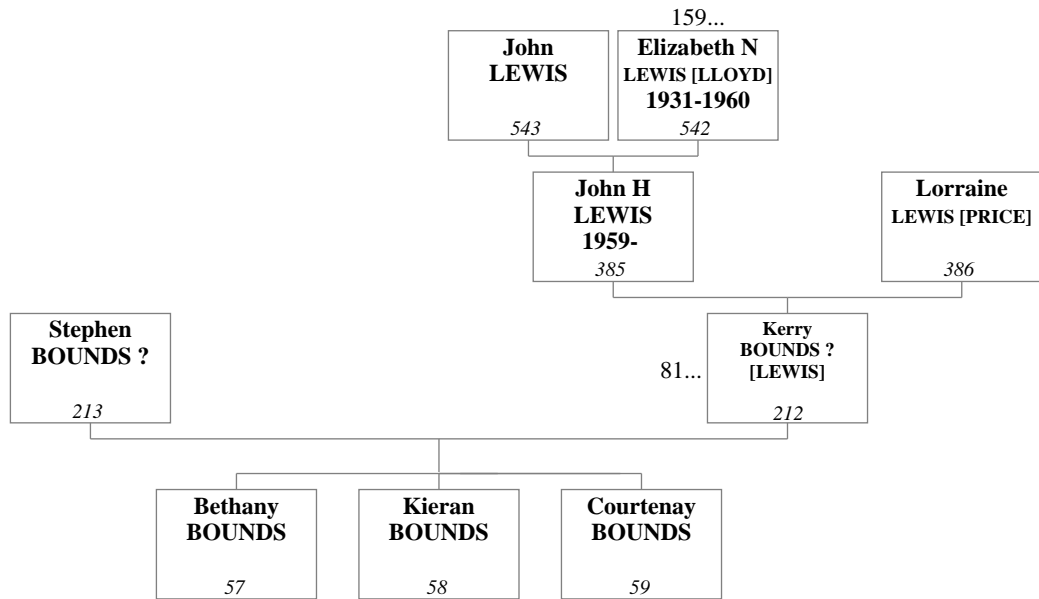

28. Richard David BYWATER and Joan S BYWATER [MARTIN]

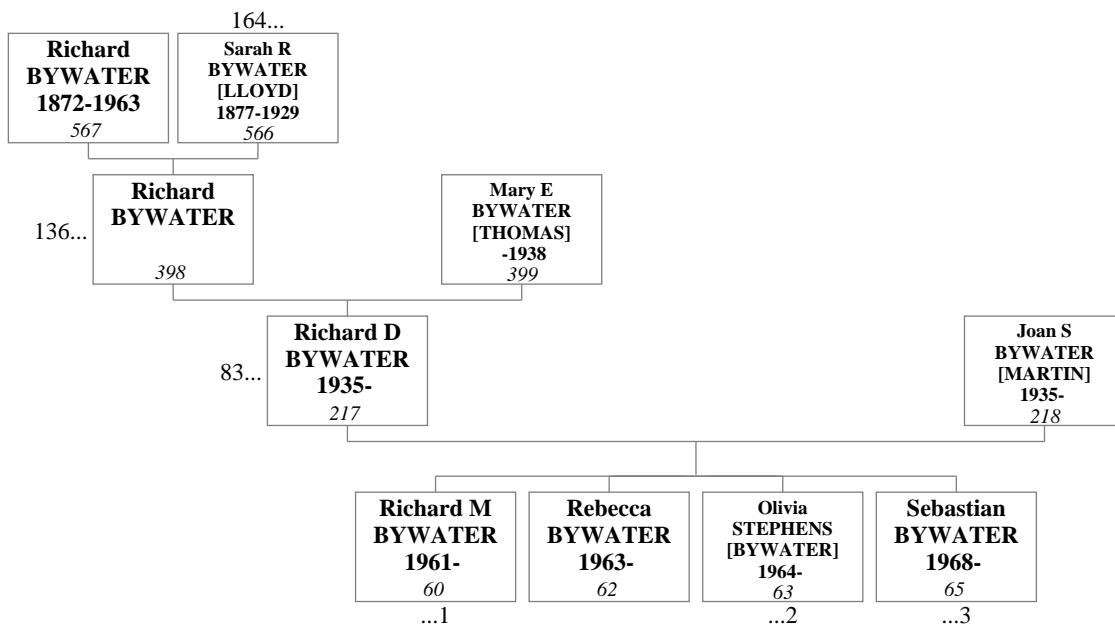

29. Gordon G LEWIS and Margaret LEWIS [BYWATER]

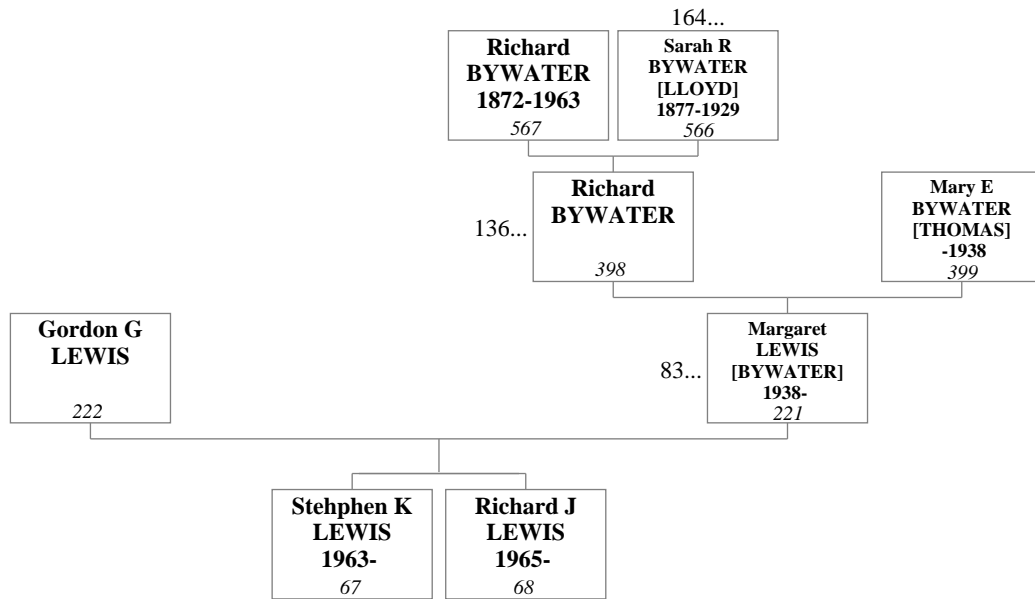

30. John BYWATER and Louise BYWATER

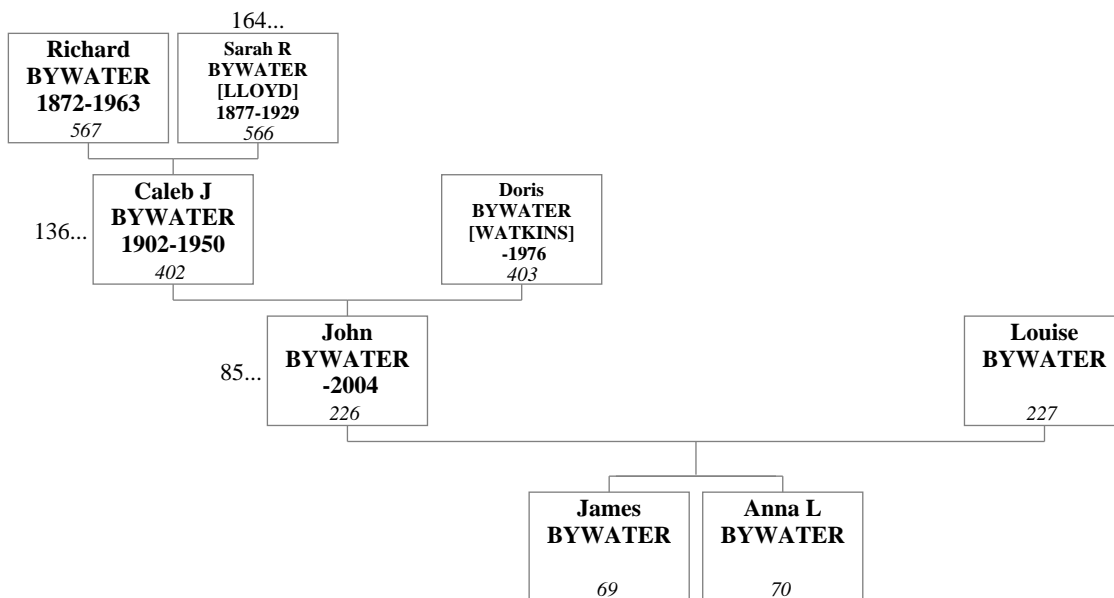

31. Jeff JAMES and Ruth JAMES [BYWATER]

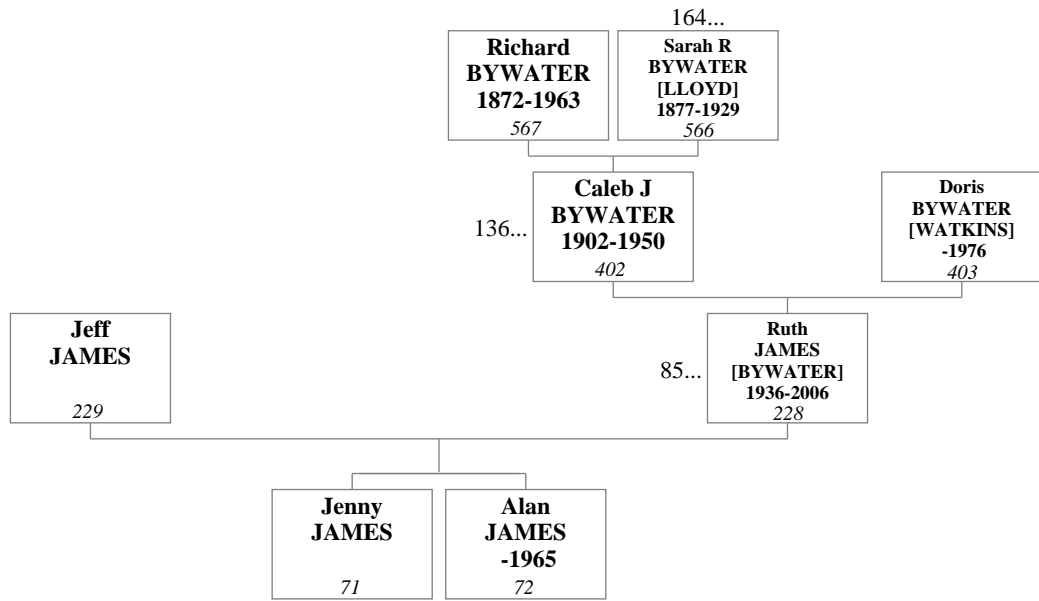

32. Robin BYWATER BVMS, PhD and May BYWATER [SCOTT]

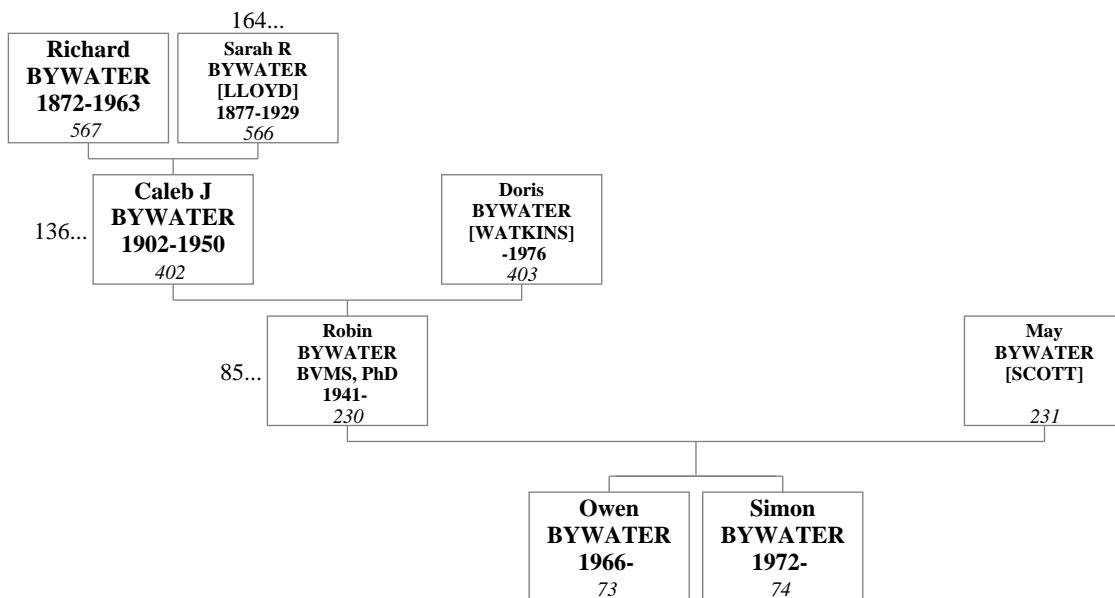

33. Russell PRICE and Sally PRICE [BYWATER]

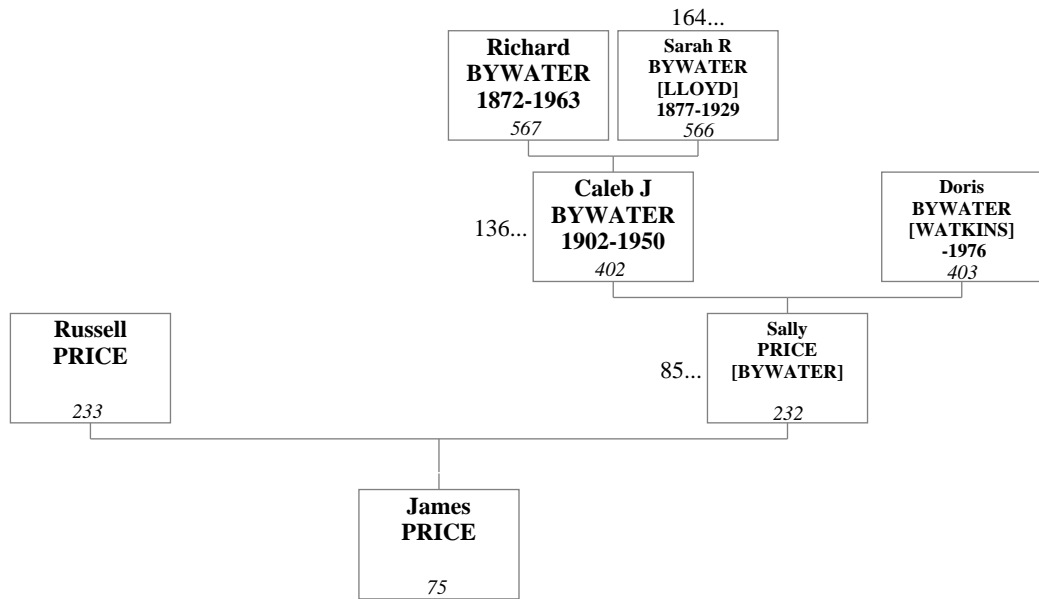

34. John BYWATER and Kate BYWATER [JONES]

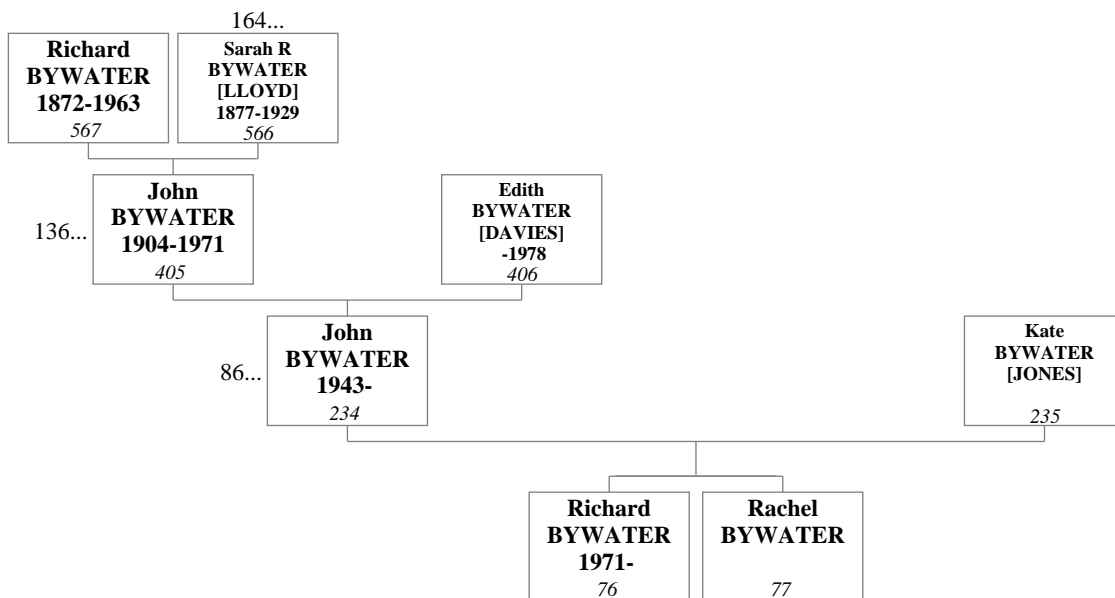

35. Roger THOMAS and Rosemary THOMAS [BYWATER]

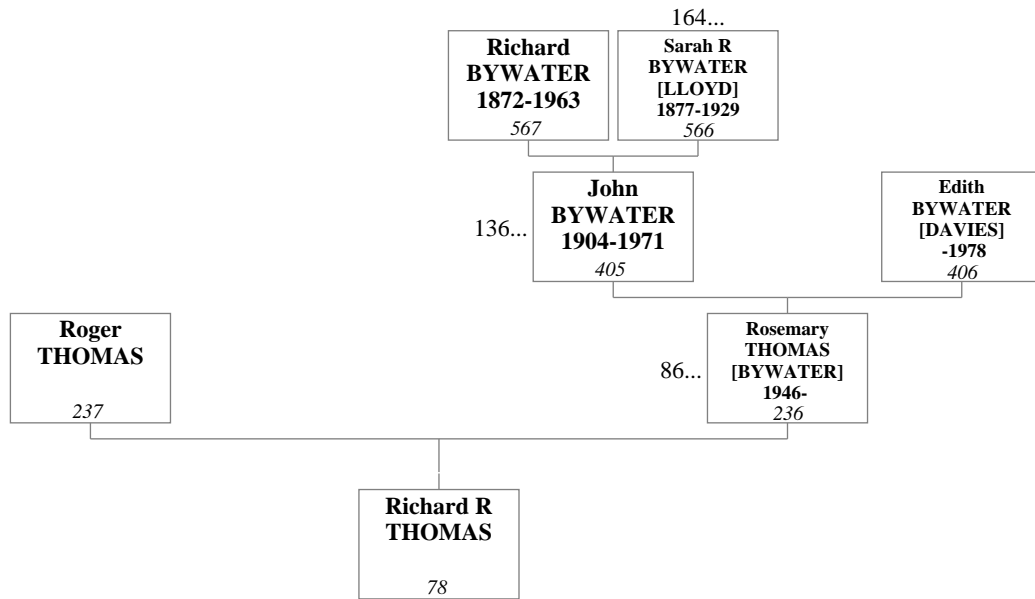

36. Richard MORRIS and Vivien MORRIS [EVANS]

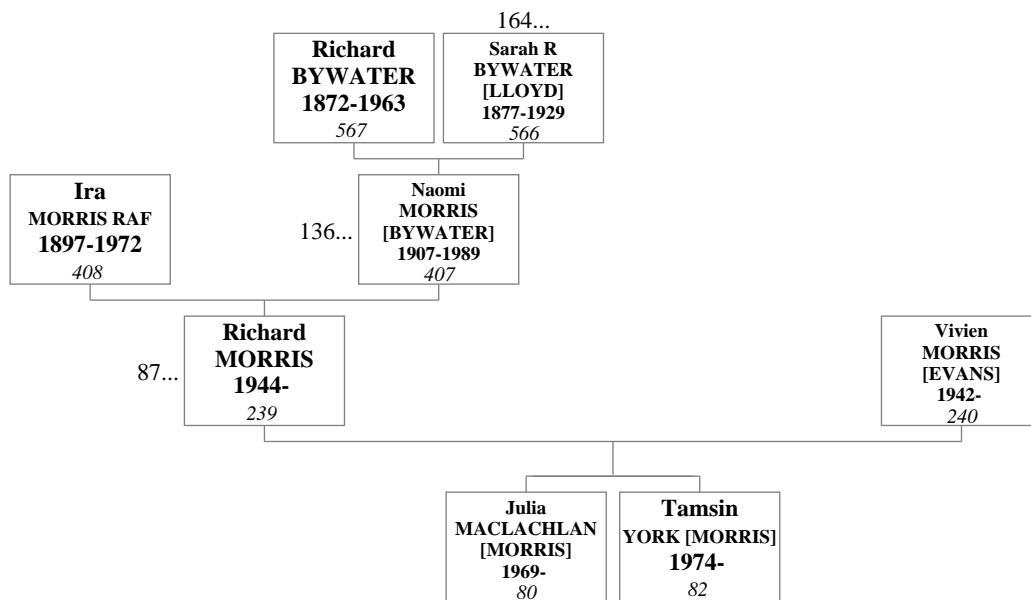

37. Murray Lloyd BYWATER and Pamela BYWATER

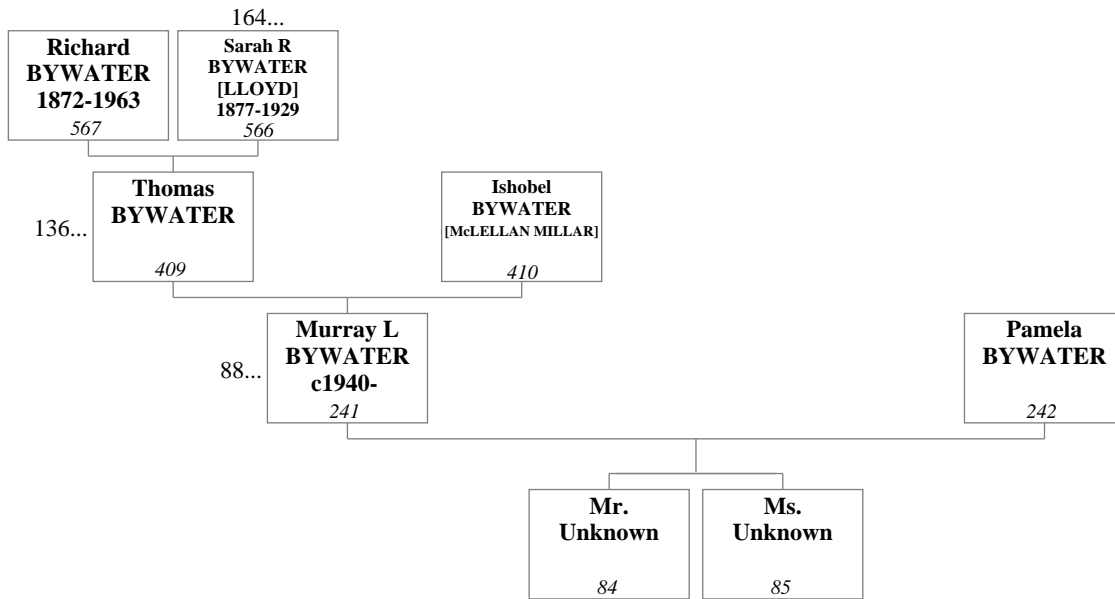

38. Peter CLIFFORD and Judith Lloyd CLIFFORD [BYWATER]

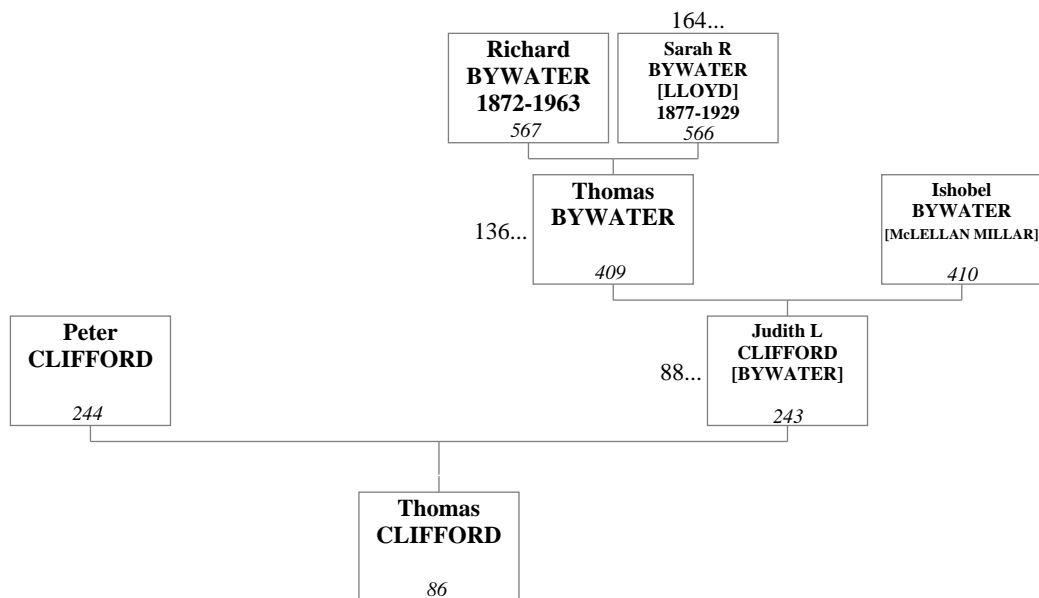

39. Richard Lloyd BYWATER and Linda BYWATER

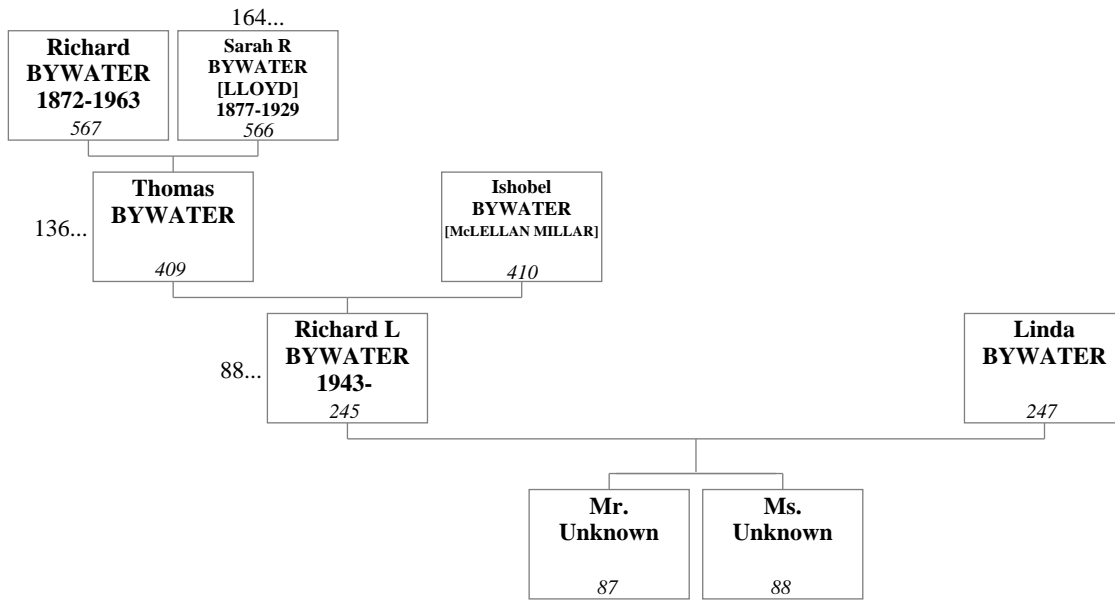

40. John BYWATER and Sue BYWATER [COXON]

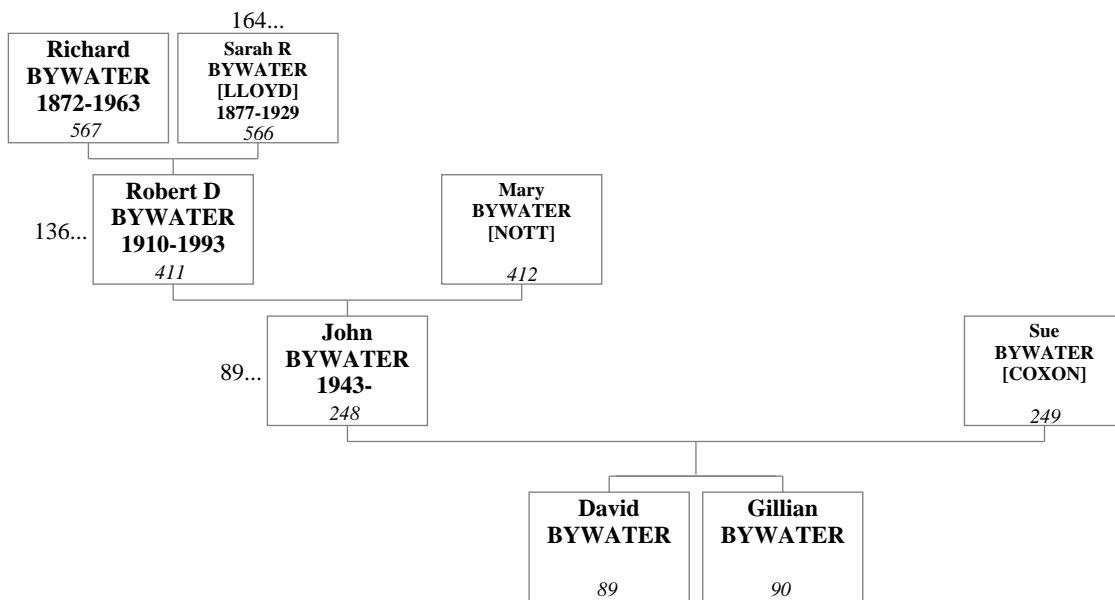

41. Edward HARRIS and Margaret HARRIS

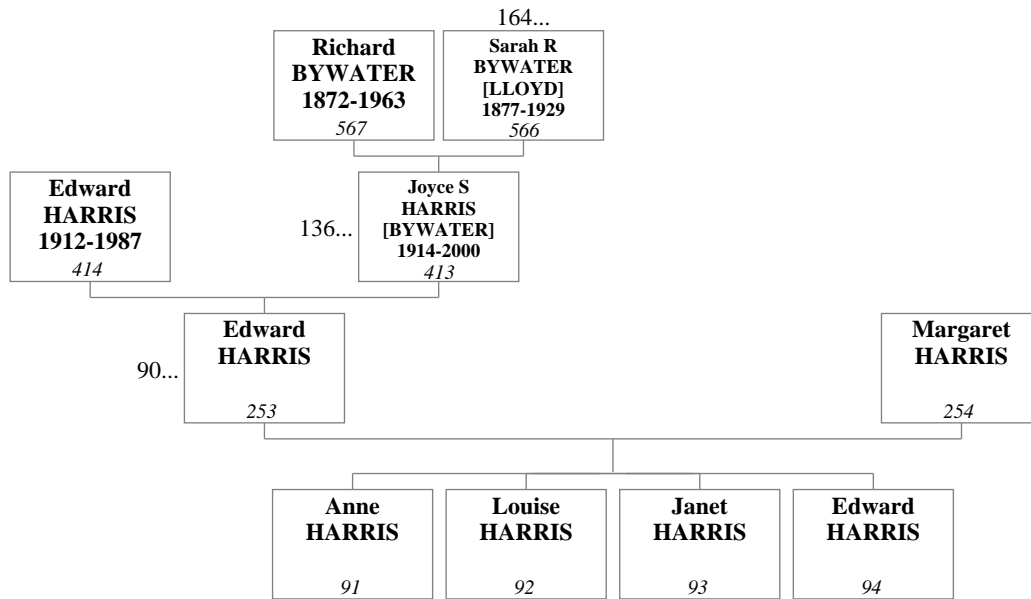

42. Thomas L HARRIS and Kathleen M HARRIS [JONES]

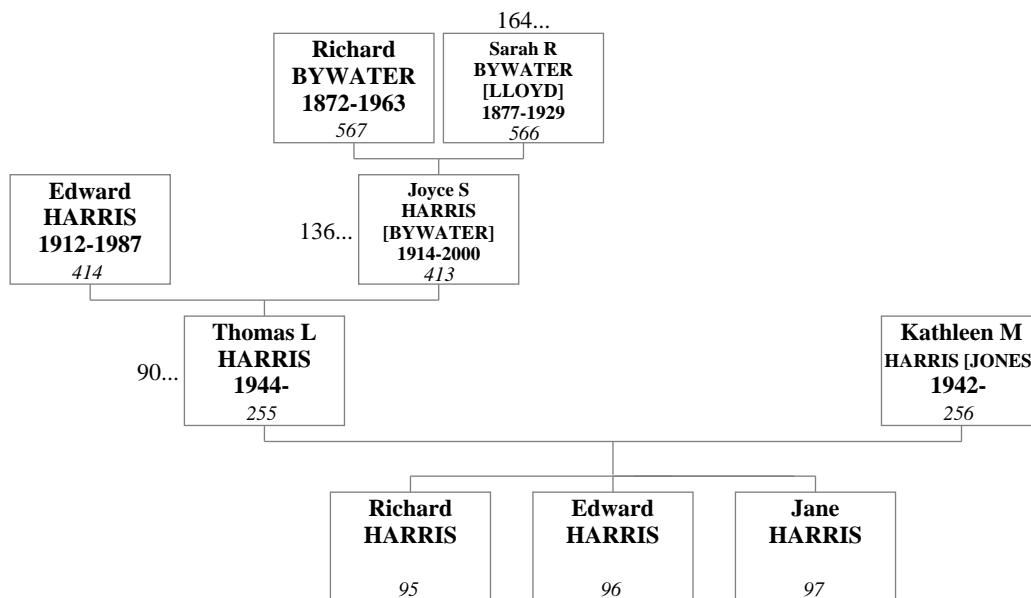

43. Charles DAVIES and Ms. DAVIES

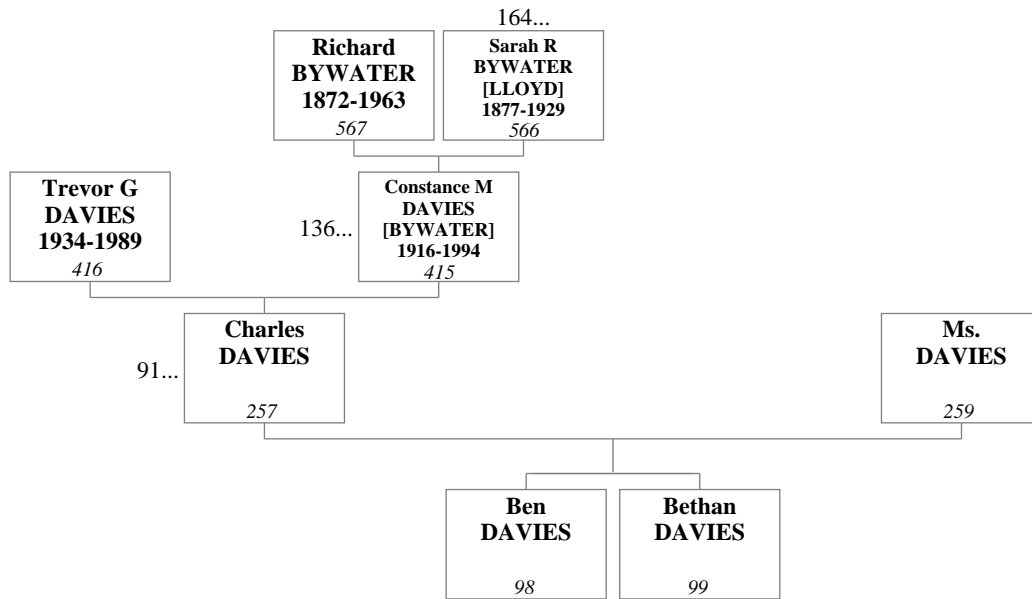

44. Mr. GRIFFITHS and Julie GRIFFITHS [DAVIES]

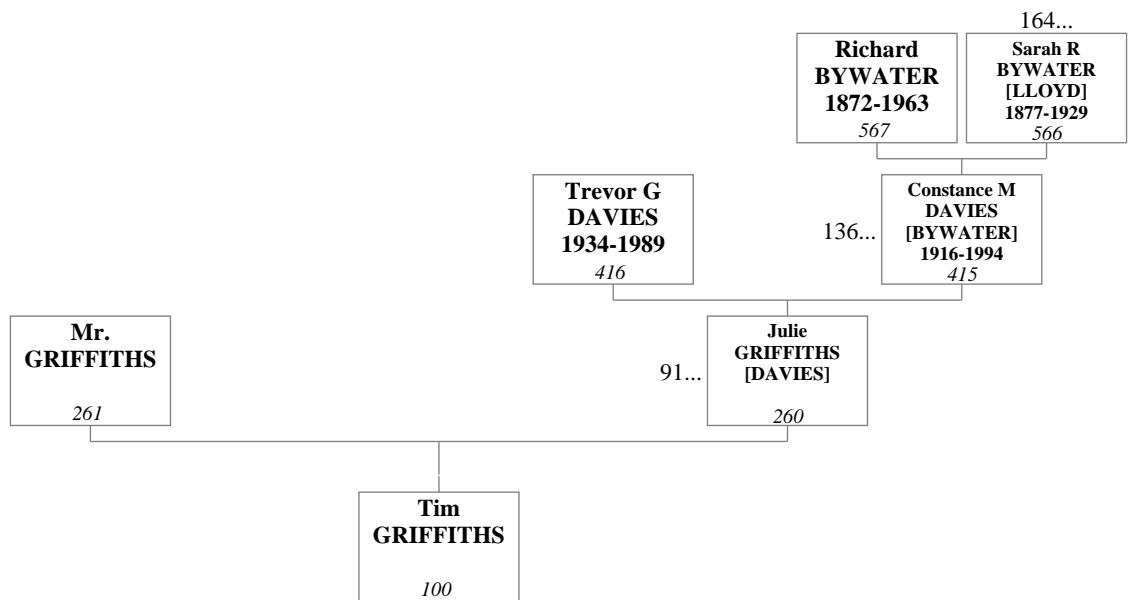

45. Dr Tony WHATELEY and Maisie Annie ROBERTS

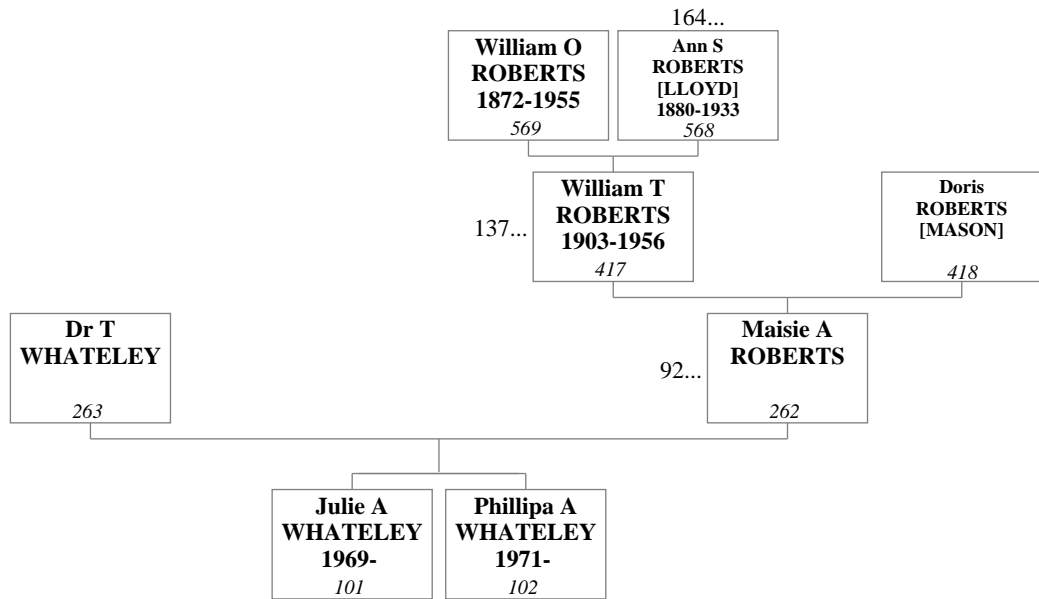

46. David WEBB and Elizabeth Mary (Betty) WEBB [ROBERTS]

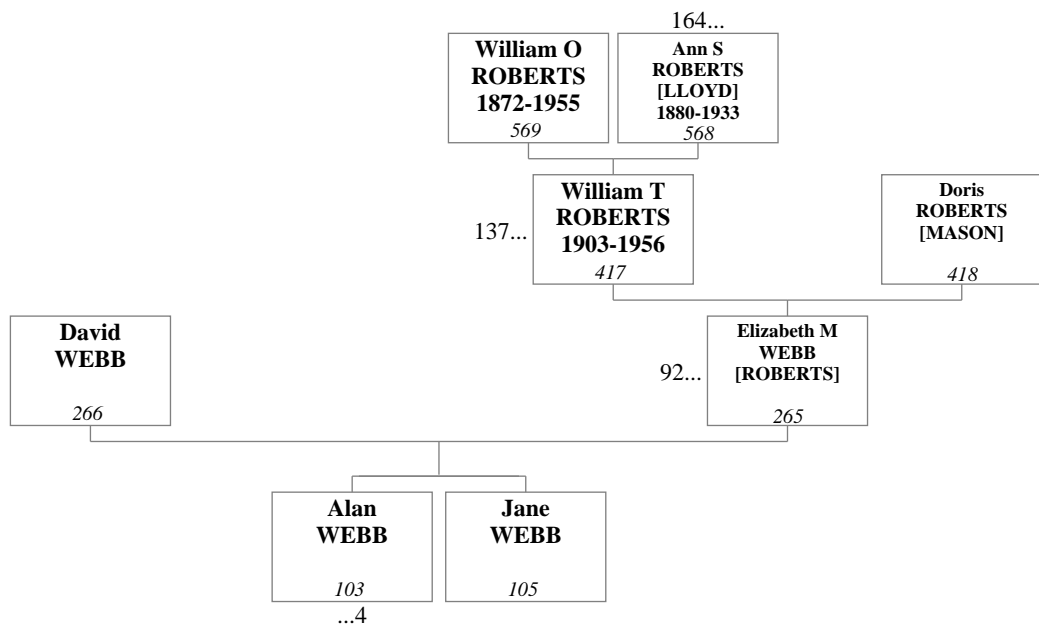

47. Newton ROBERTS

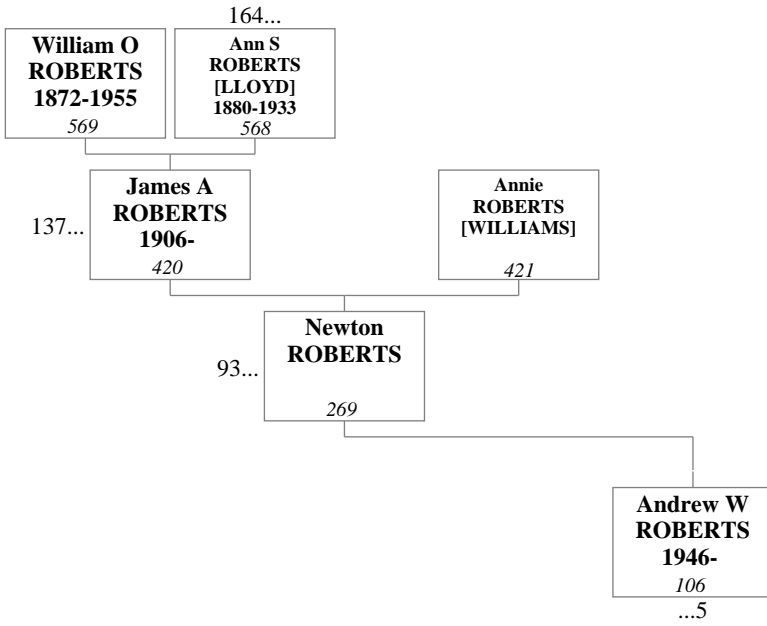

48. Caleb Thomas ROBERTS

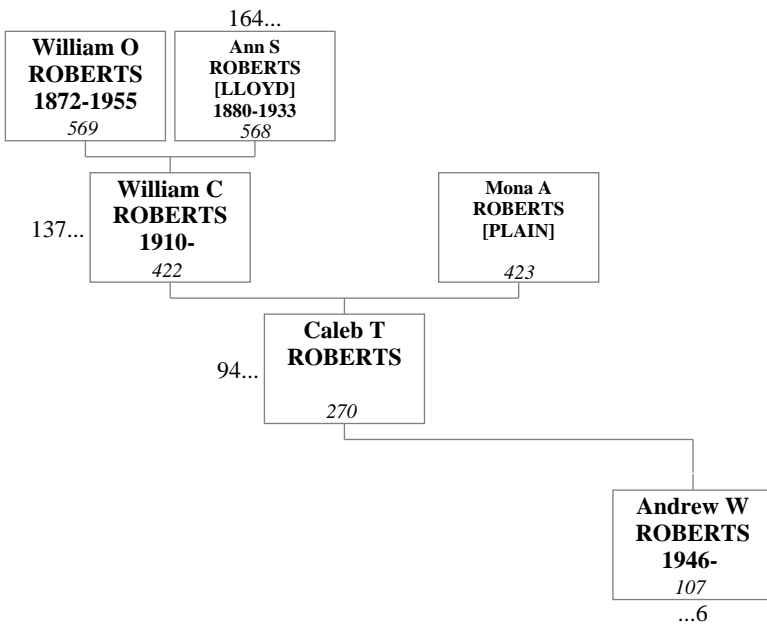

49. Derek BROWN and Muriel Doreen LLOYD

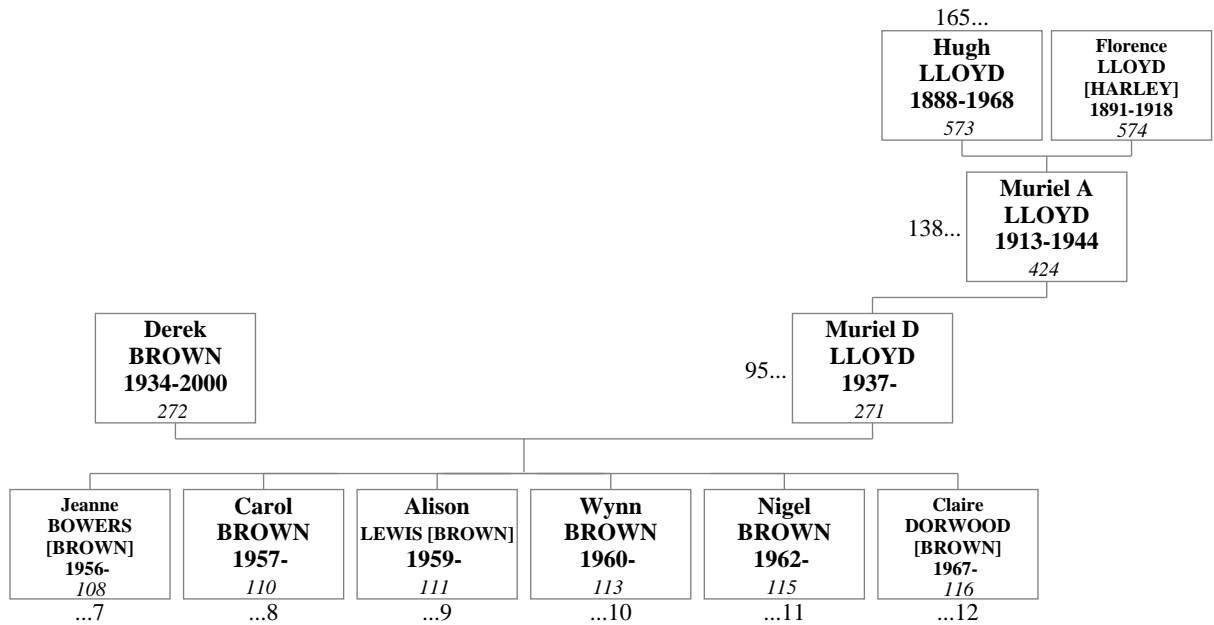

50. Meic STEPHENS MA Dlott and Ruth Wynn STEPHENS [MEREDITH]

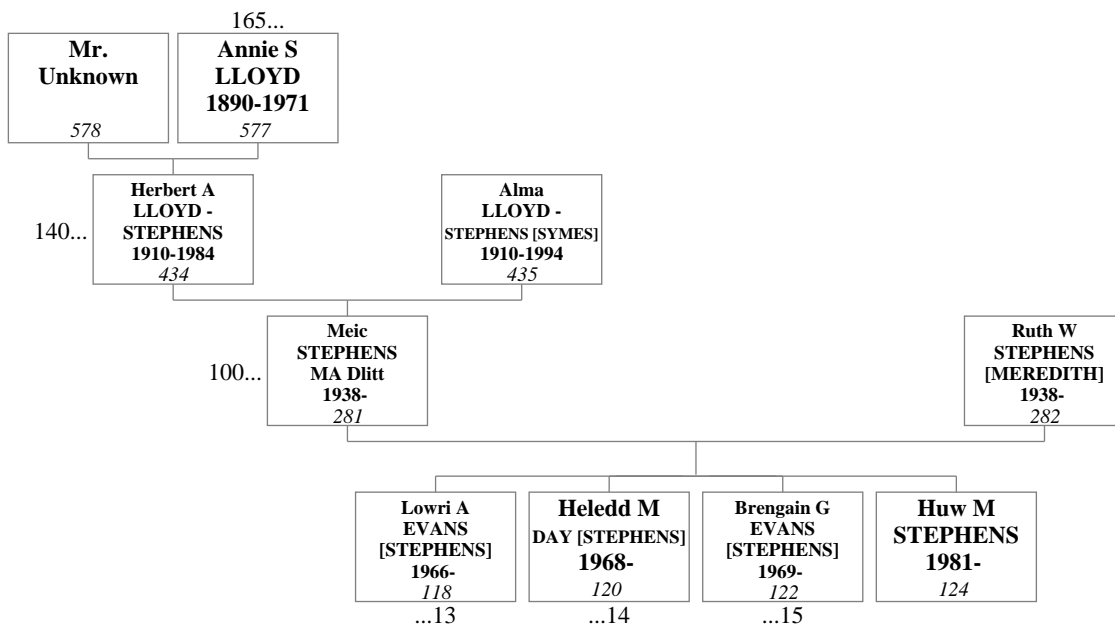

51. Lloyd STEPHENS and Margaret Patricia Ismay STEPHENS [MORRIS]

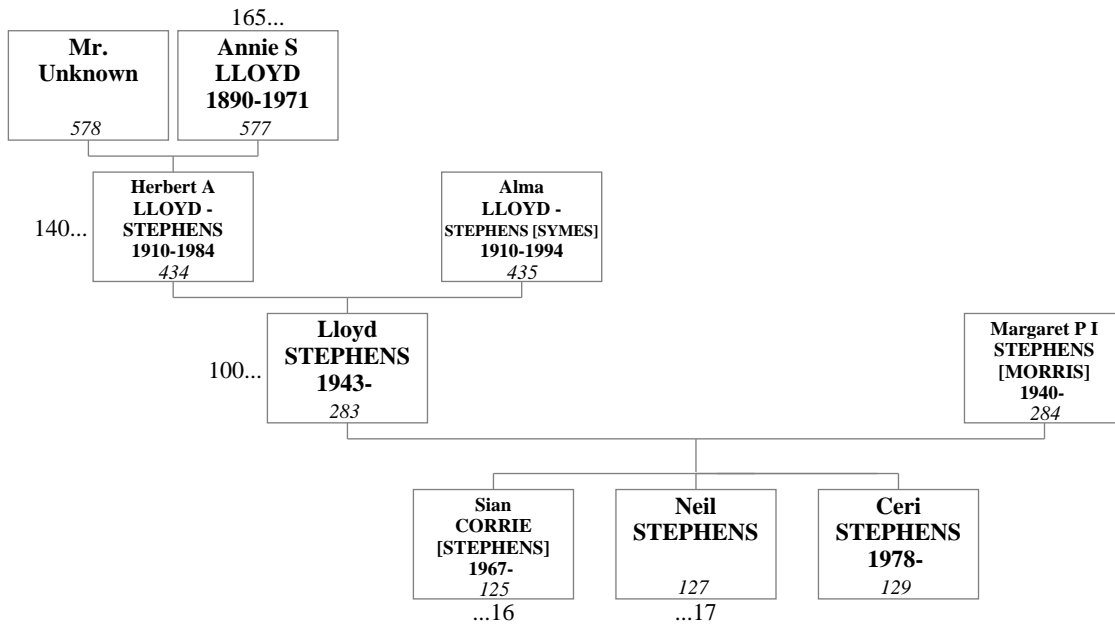

52. Aubrey E Michael PRITCHETT and Janet PRITCHETT [BEASLEY]

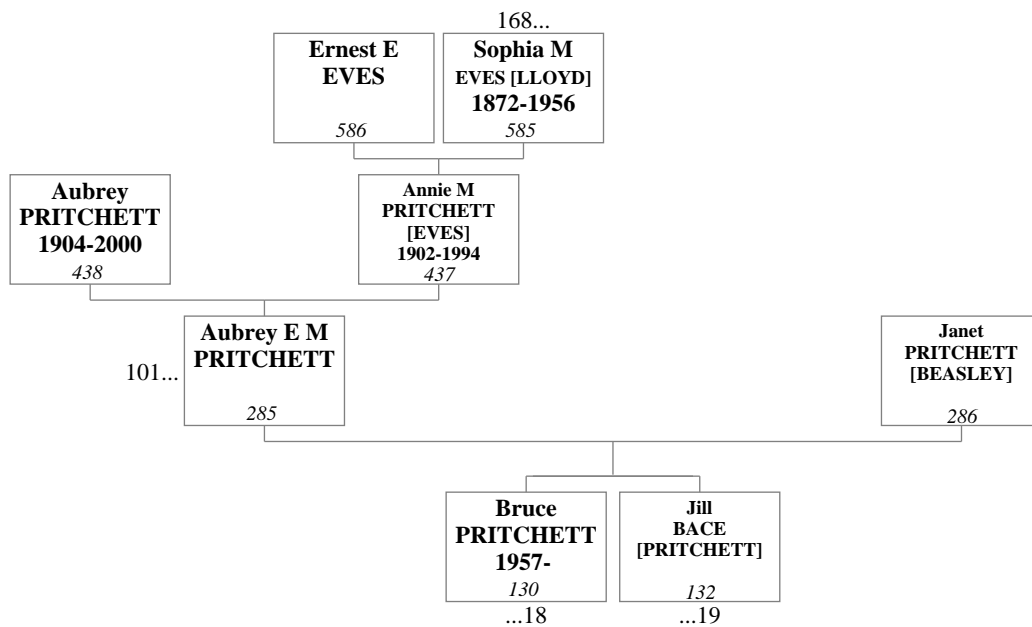

53. Philip LANE and Susan LANE

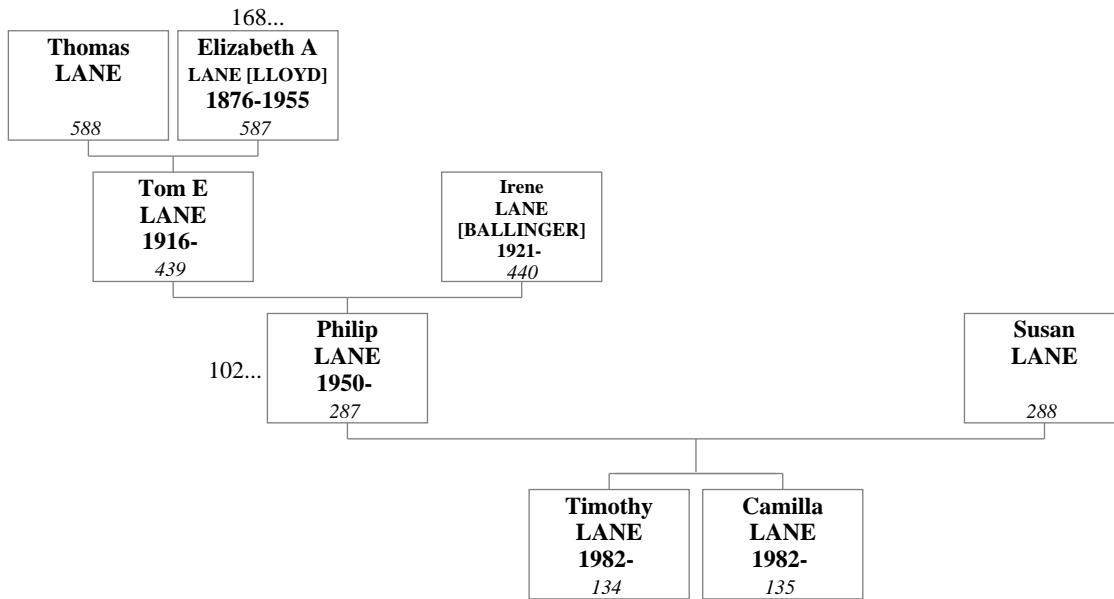

54. David Philip John LLOYD CEng, CIP, MBCS., MAPM and Maria Alexandra LLOYD [BUBEAR] RGN RMN

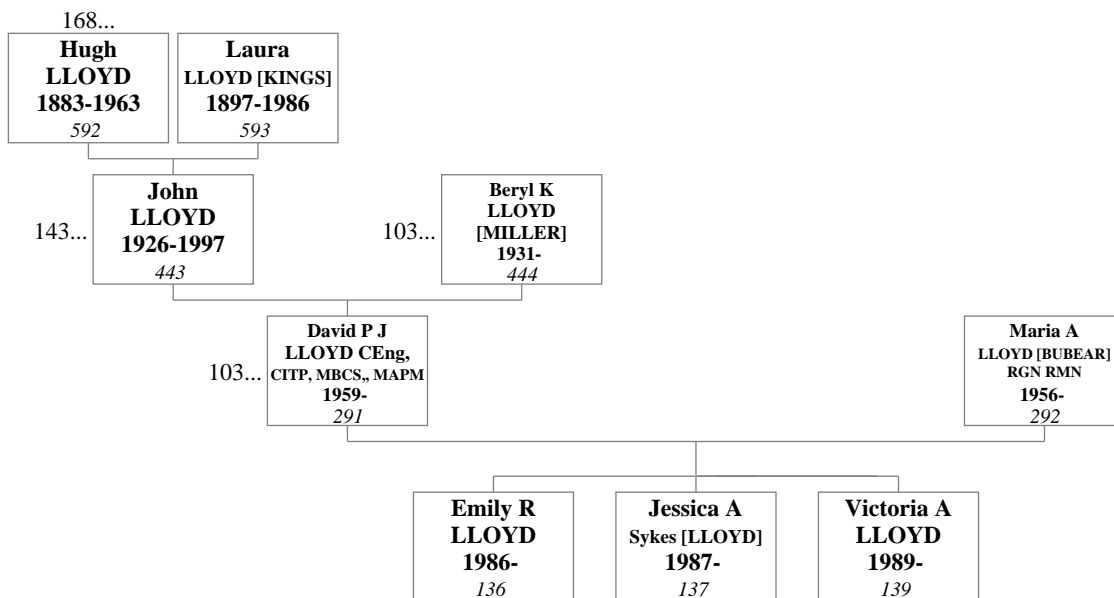

55. Peter Geoffrey LLOYD and Karen Margaret LLOYD [DAWE]

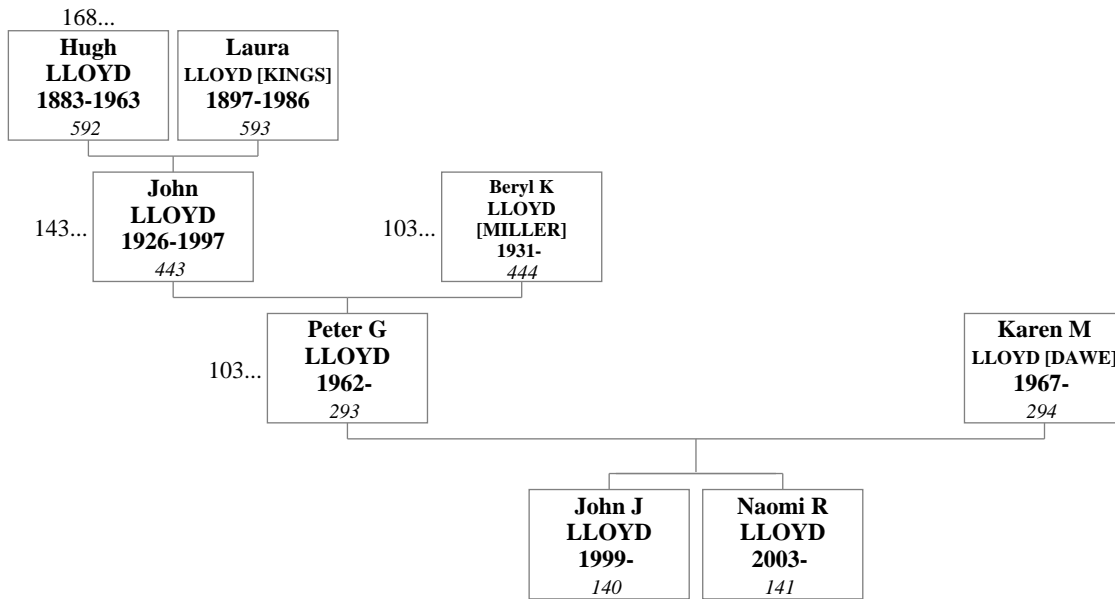

56. Andrew Robert LLOYD RAF and Cheryl Esther LLOYD [DUGGAN]

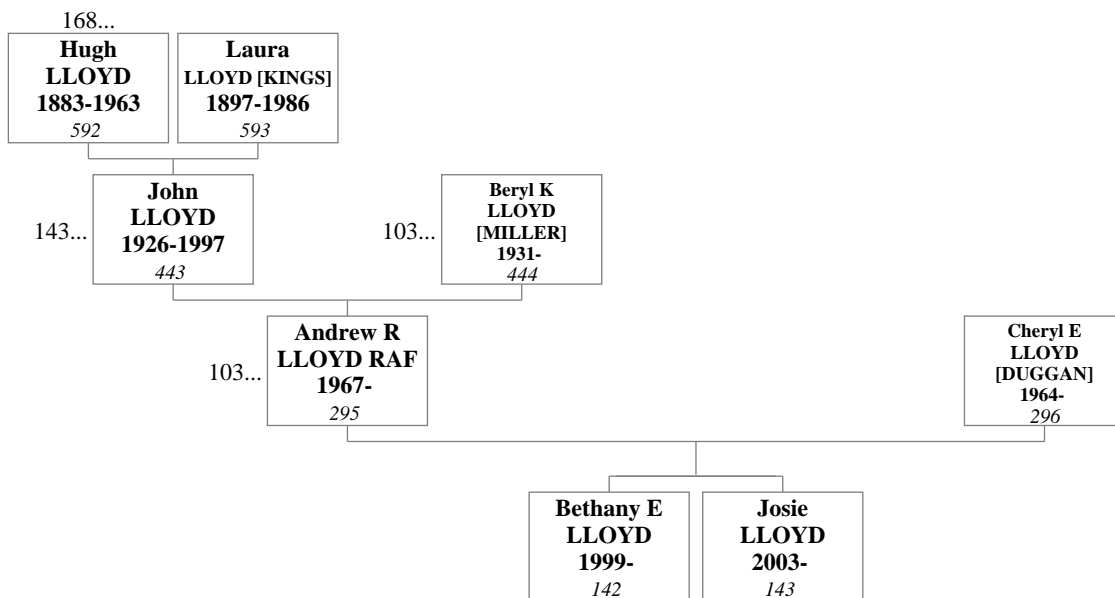

57. Robin LEWIS and Kathryn Ann LEWIS [BOWS] BMedSci , BM, BS

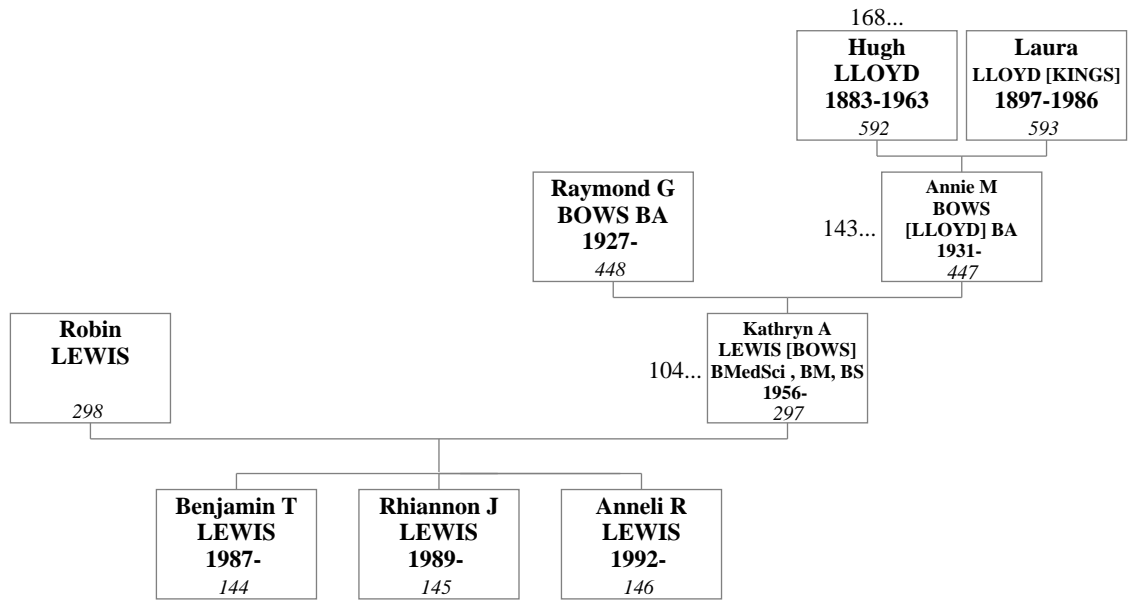

58. Richard BOWS RAF (Retd) and Terri BOWS [EASTWOOD]

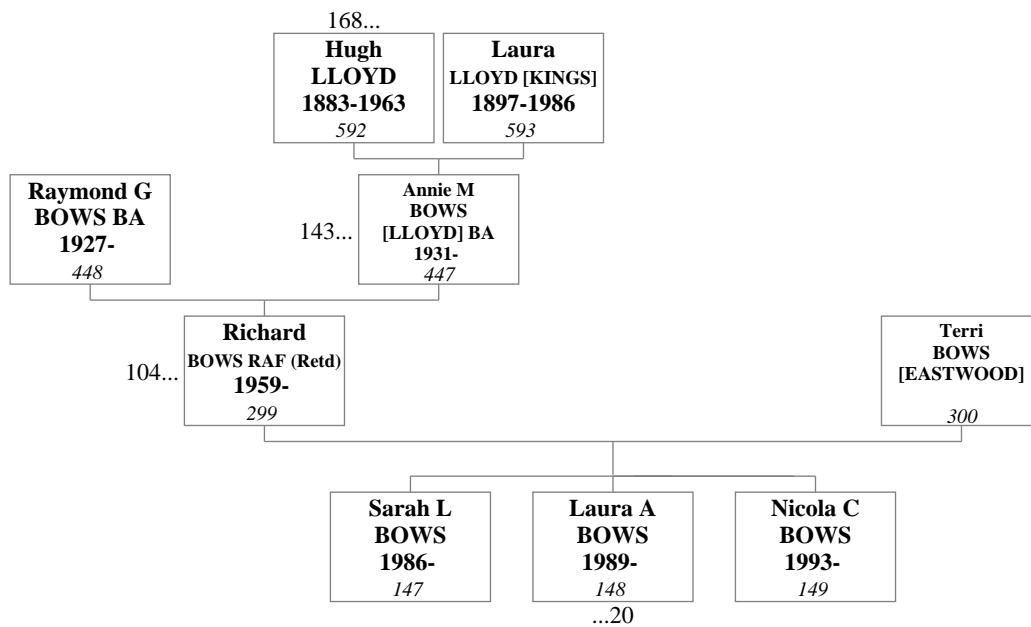

59. Stephen Gareth LLOYD BSc, D.C and Juliet LLOYD [DENMAN] Grad Dip TH

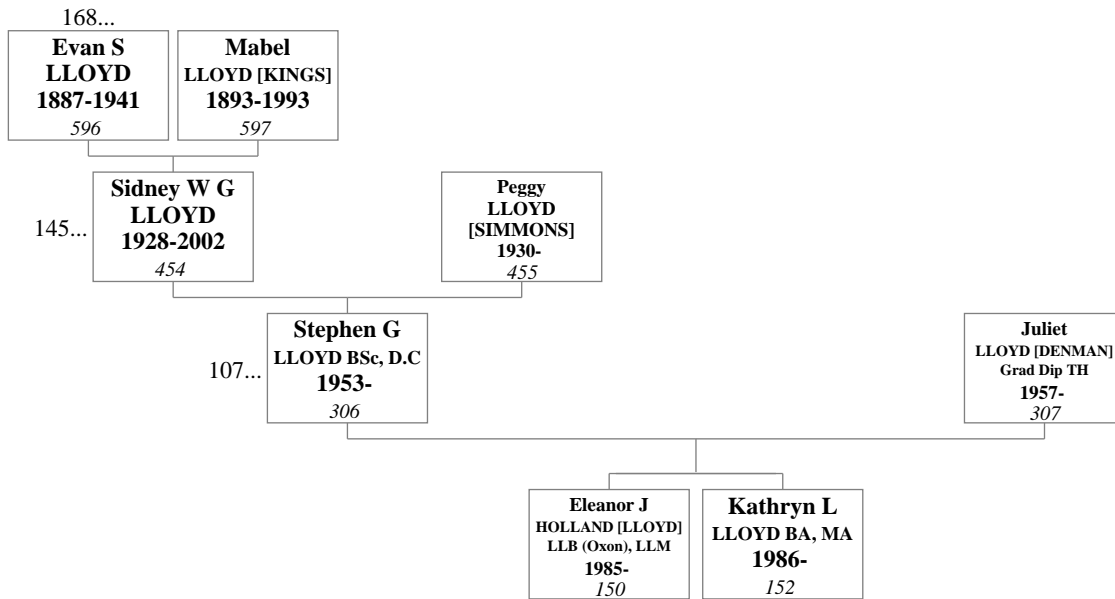

60. Peter Adrian LLOYD and Catherine LLOYD [FOLEY]

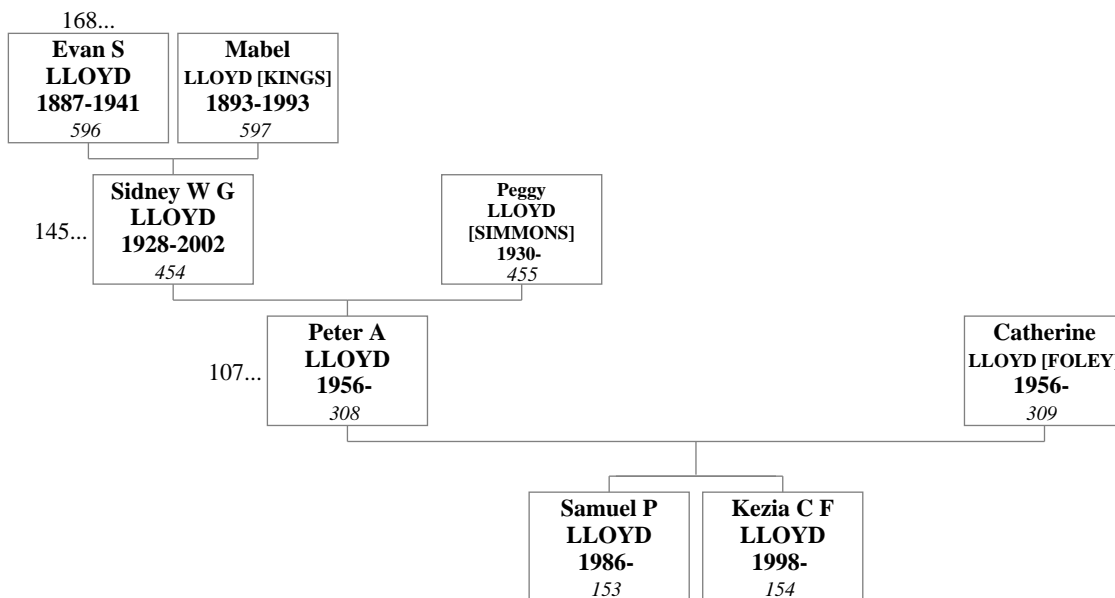

61. David EARTHROWL and Bronwen Dorothy STRATTON

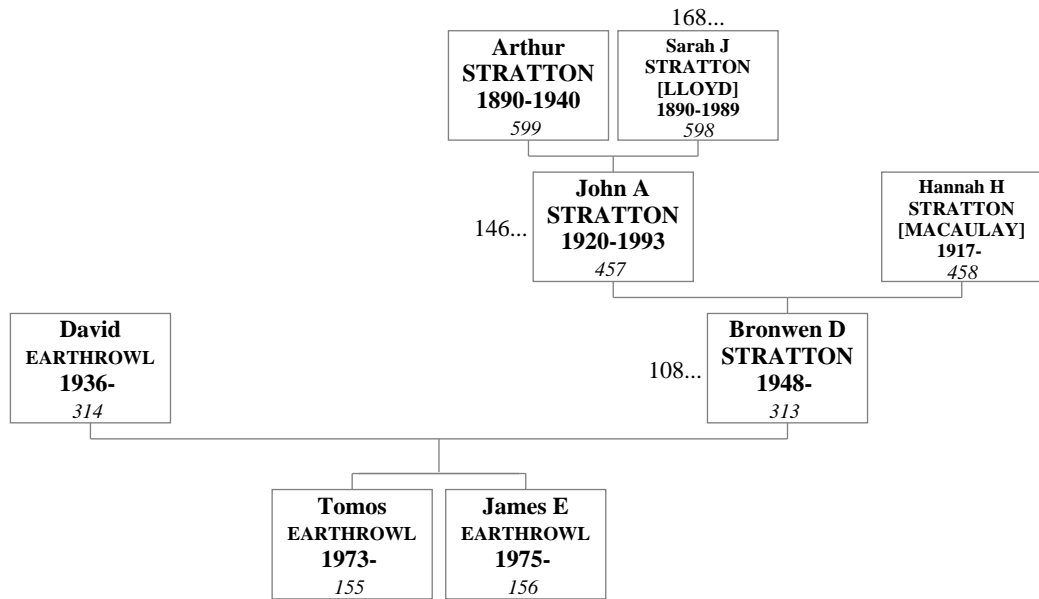

62. Christopher Illtyd LEWIS and Janet LEWIS [ROBERTS-LEWIS]

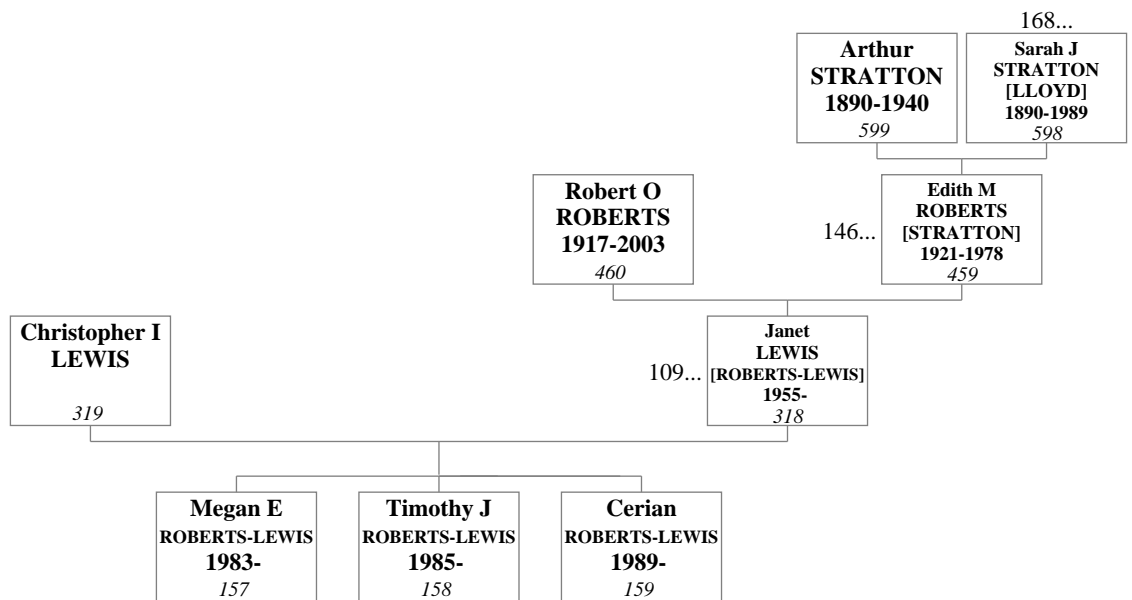

63. John JONES and Sandra JONES [MORGAN]

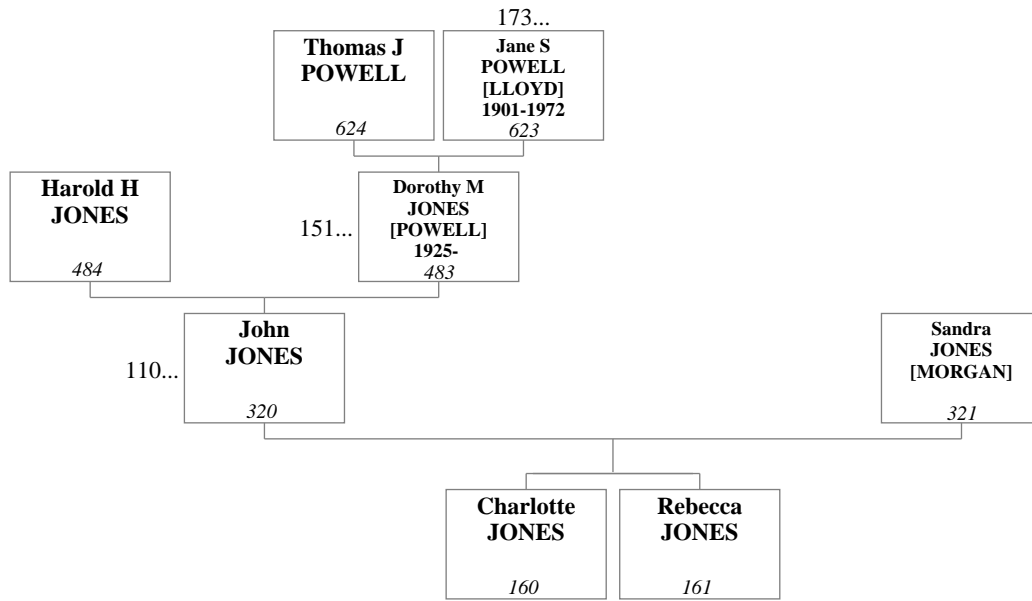

64. Robert JONES and Nicola JONES [EVANS]

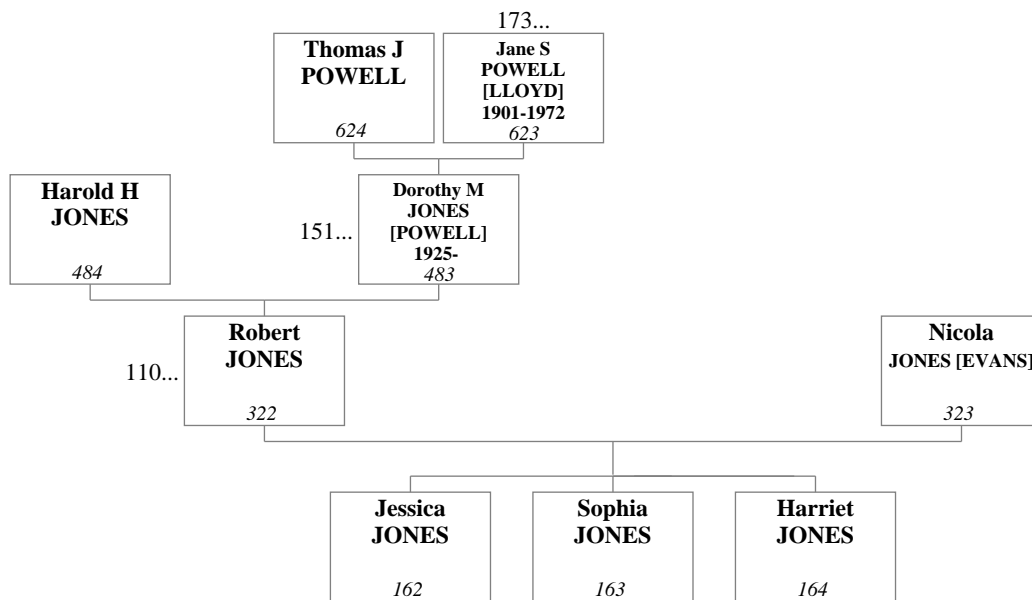

65. Timothy BLANDFORD and Ann BLANDFORD [JONES]

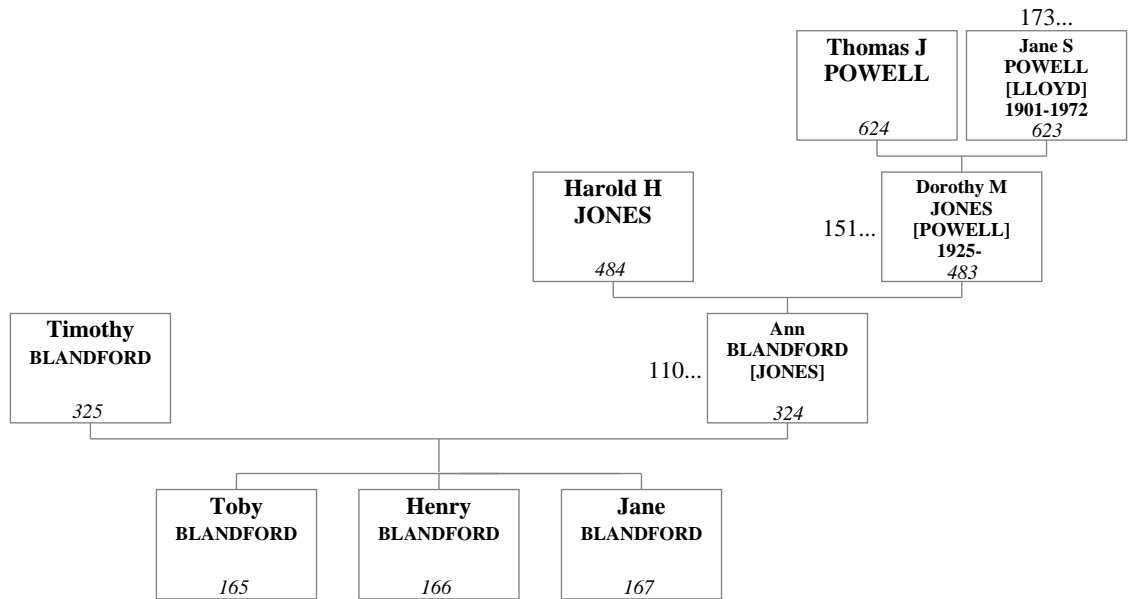

66. Karl HARRISON and Jane HARRISON [POWELL]

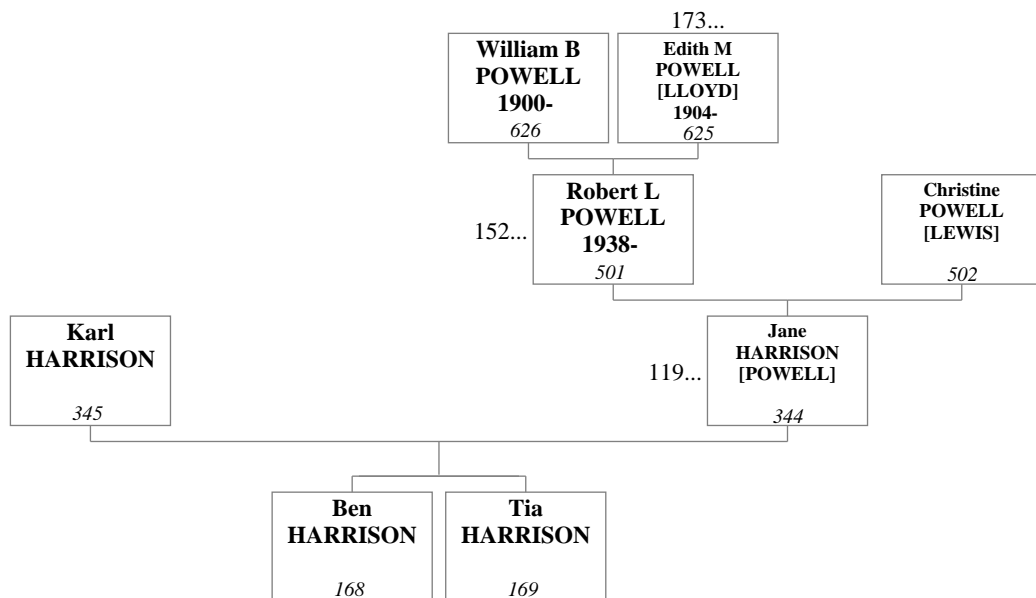

67. Stephen TUFT and Clare TUFT [POWELL]

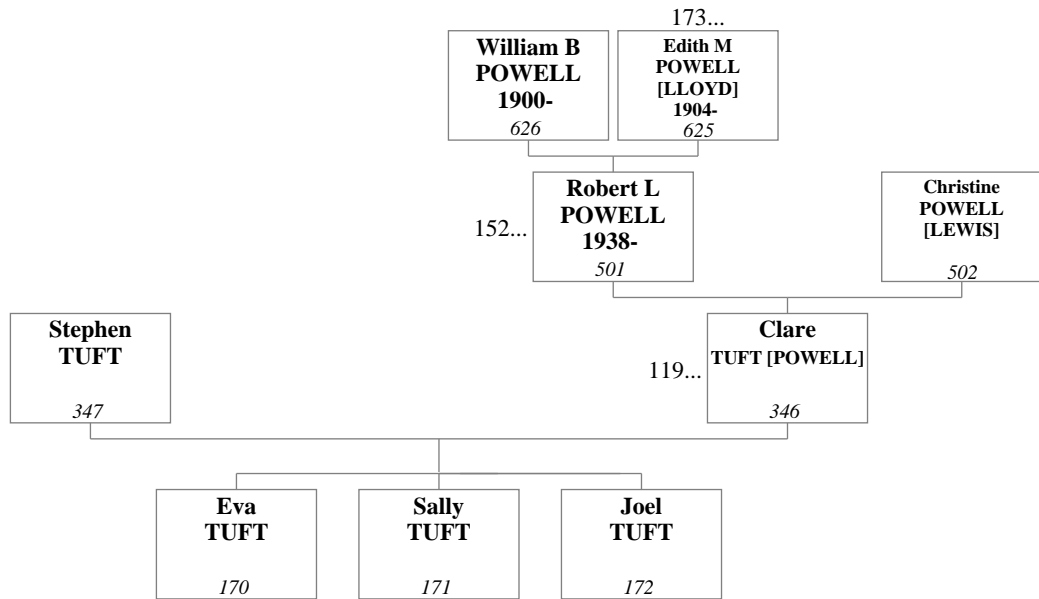

68. Kenneth (Ken) WILLIAMS and Vera Lindsley WILLIAMS

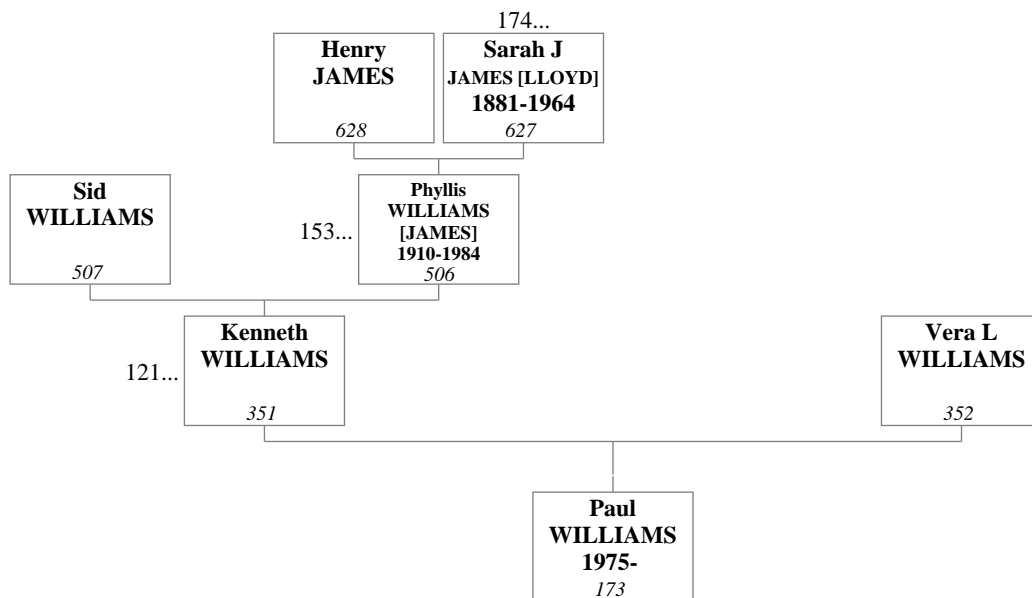

69. Glyn WILLIAMS and Dilys WILLIAMS [WATKINS]

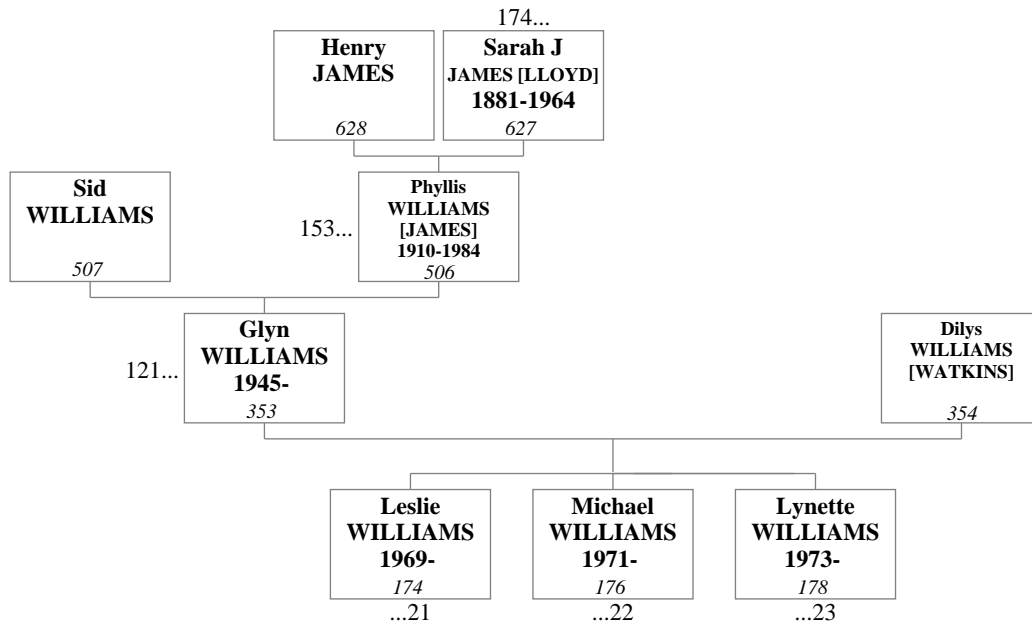

70. Herbert Oliver FARMER and Rita Hazel FARMER [JAMES]

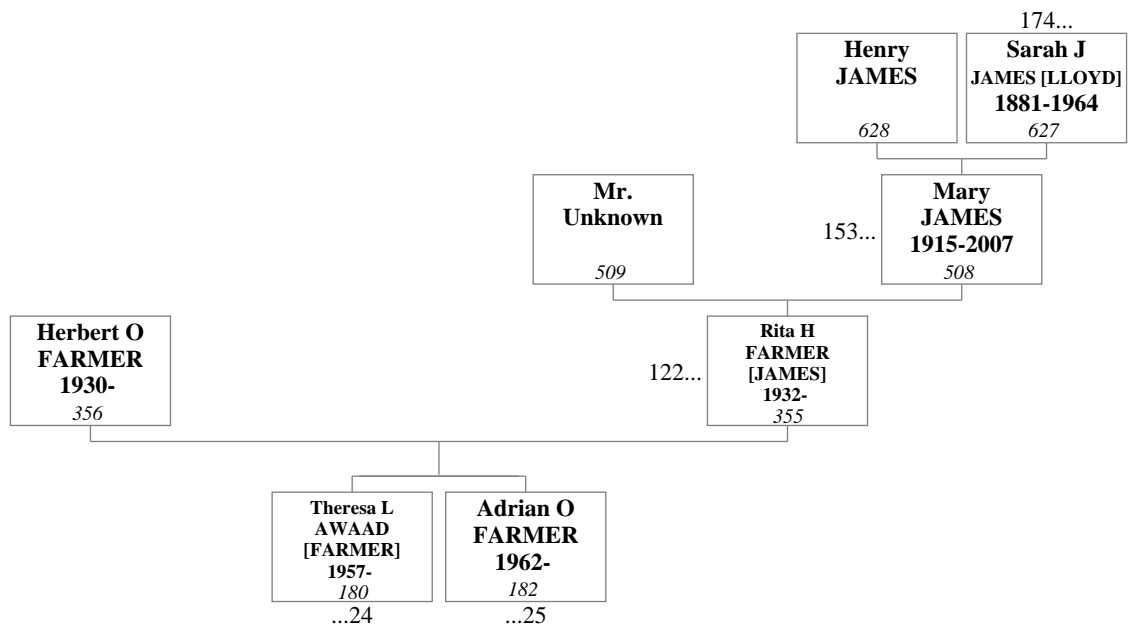

71. Winston Barrie MORGAN and Nancy C MORGAN [TAYLOR]

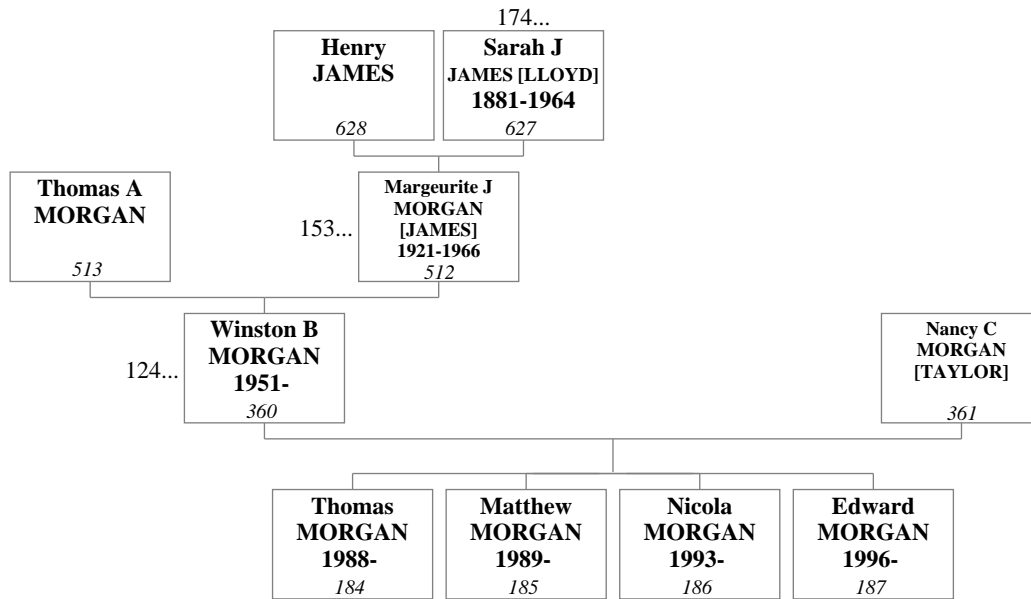

72. Roger John NEWTON and Elizabeth Anne NEWTON [LLOYD]

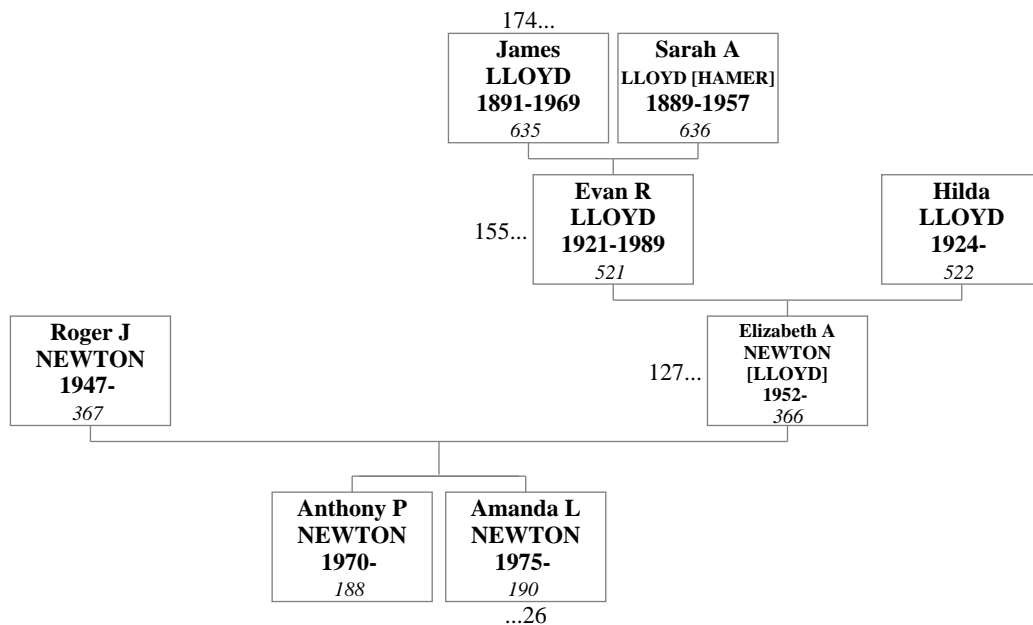

73. David Evan LLOYD and Irene LLOYD [DURRELL]

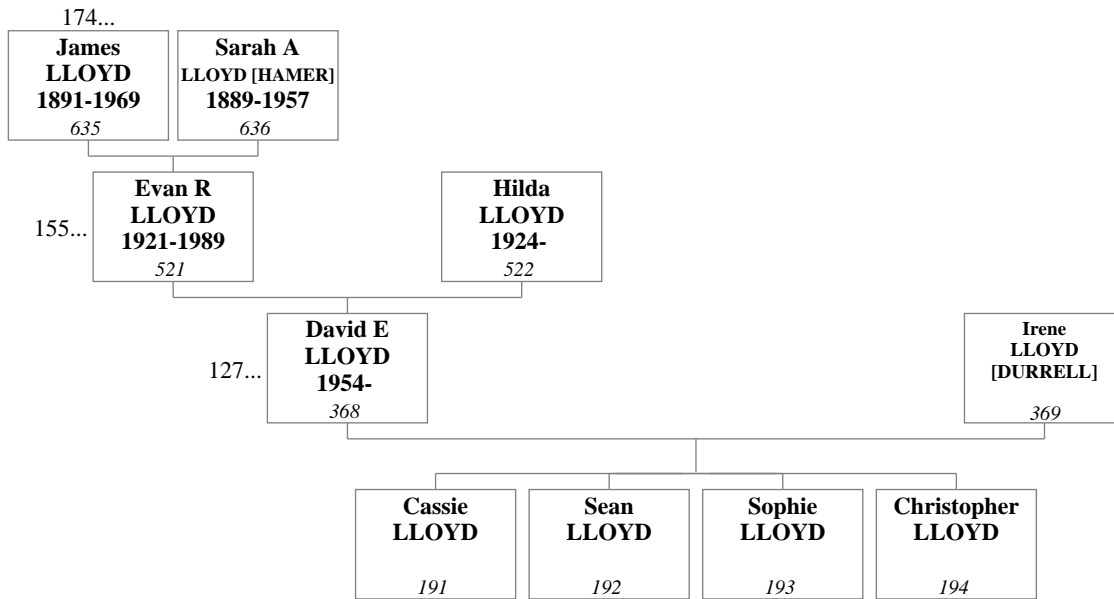

74. Graham C LLOYD and Wendy LLOYD [WILLIAMS]

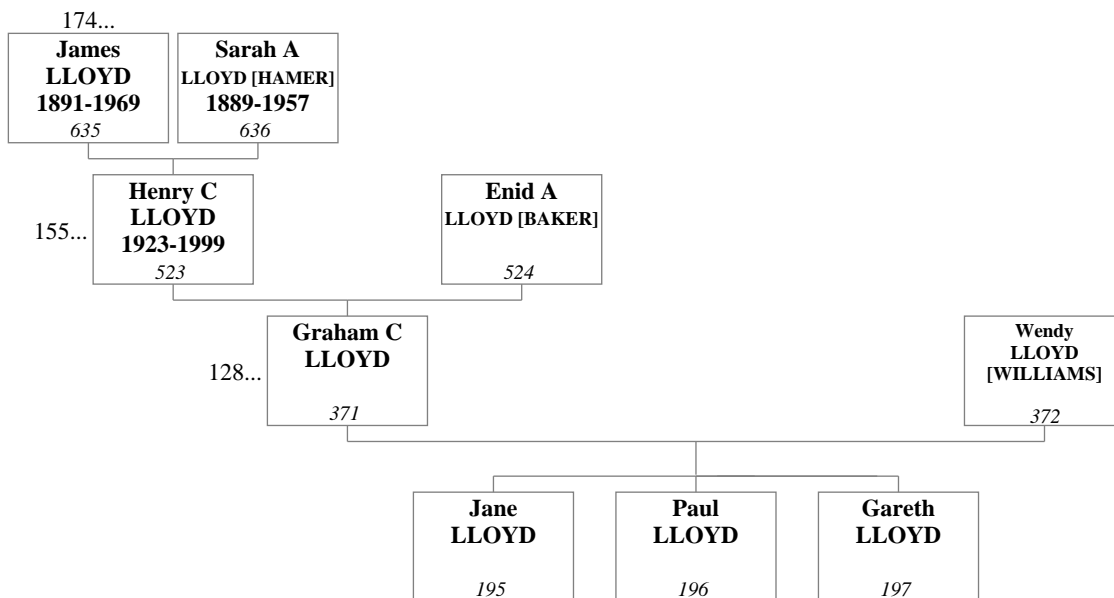

75. Richard Philip SKYRME and Anita Jane SKYRME [POWELL]

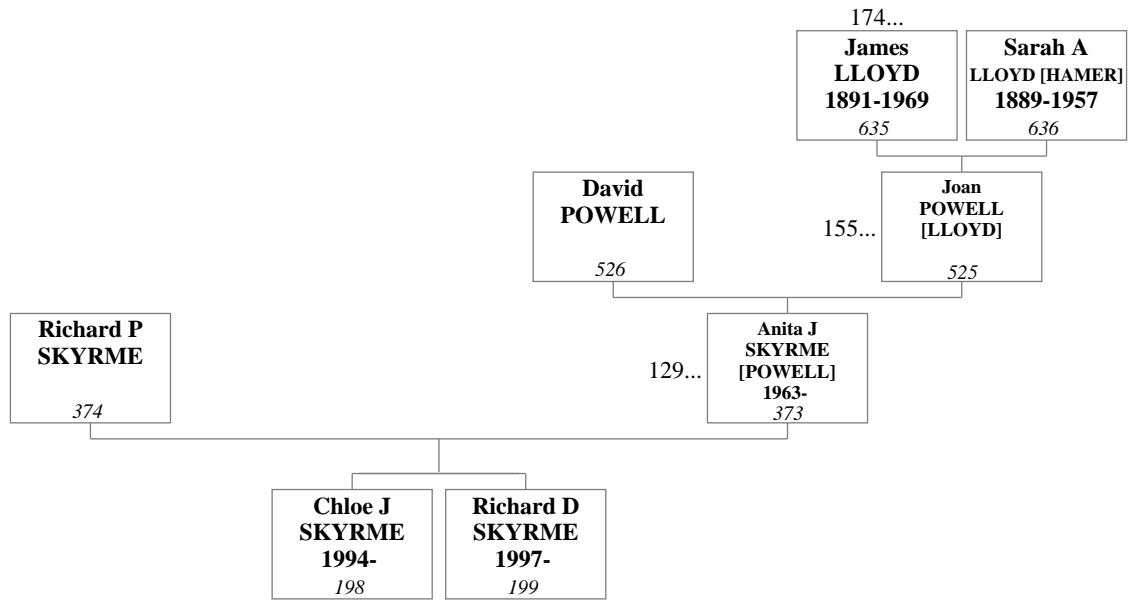

76. Christopher John WILLIAMS and Kathryn Ann WILLIAMS [POWELL]

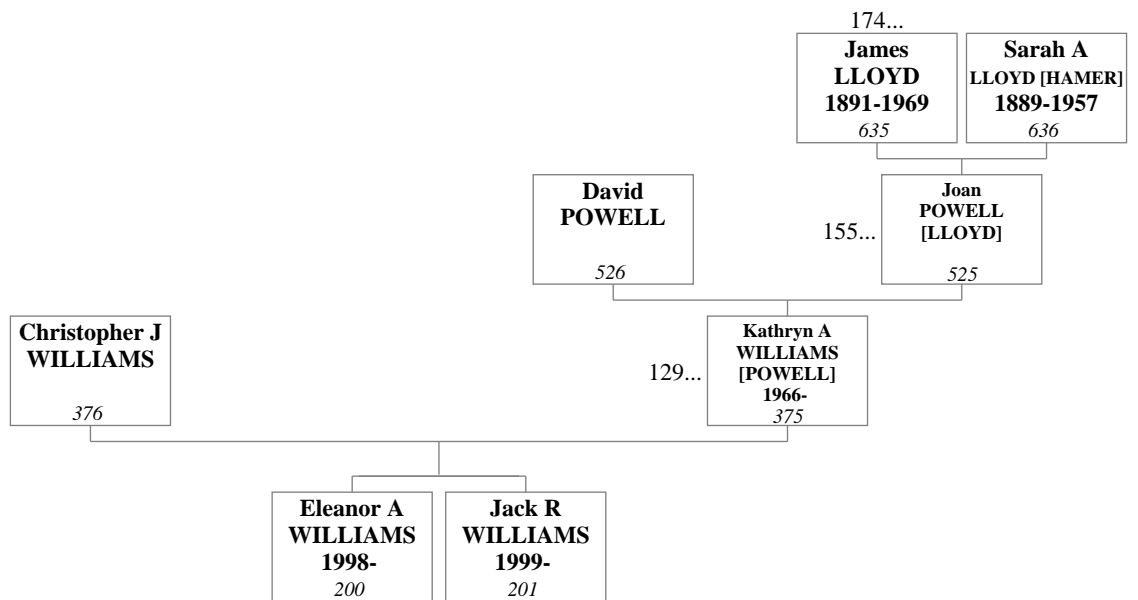

77. Alan Hugh LLOYD and Sarah Marie LLOYD [GOUGH]

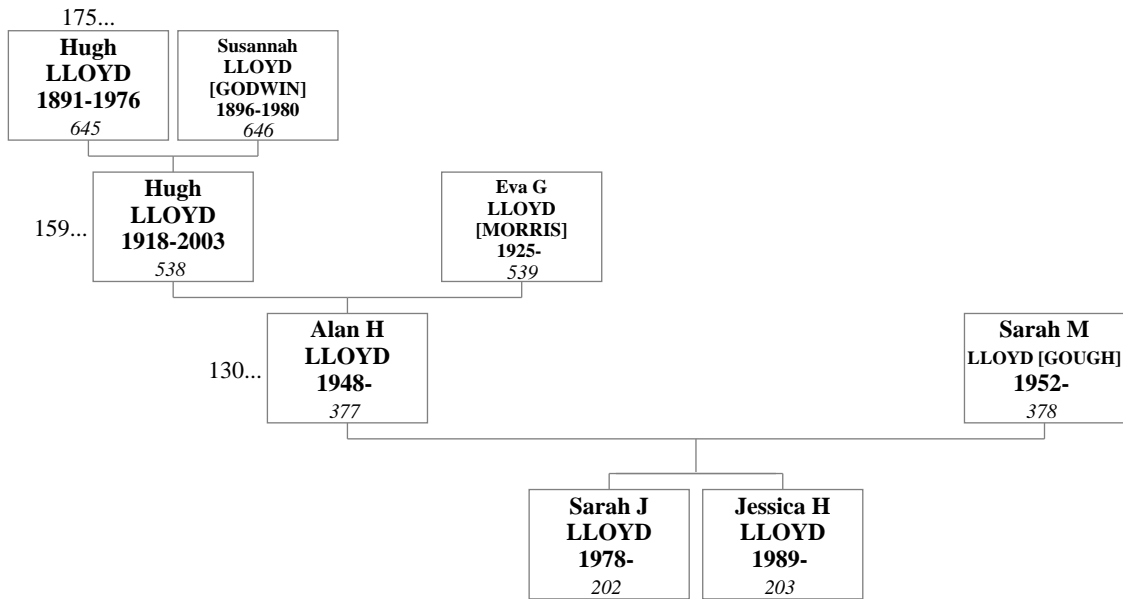

78. Elwyn John LLOYD and Jane LLOYD [HYATT]

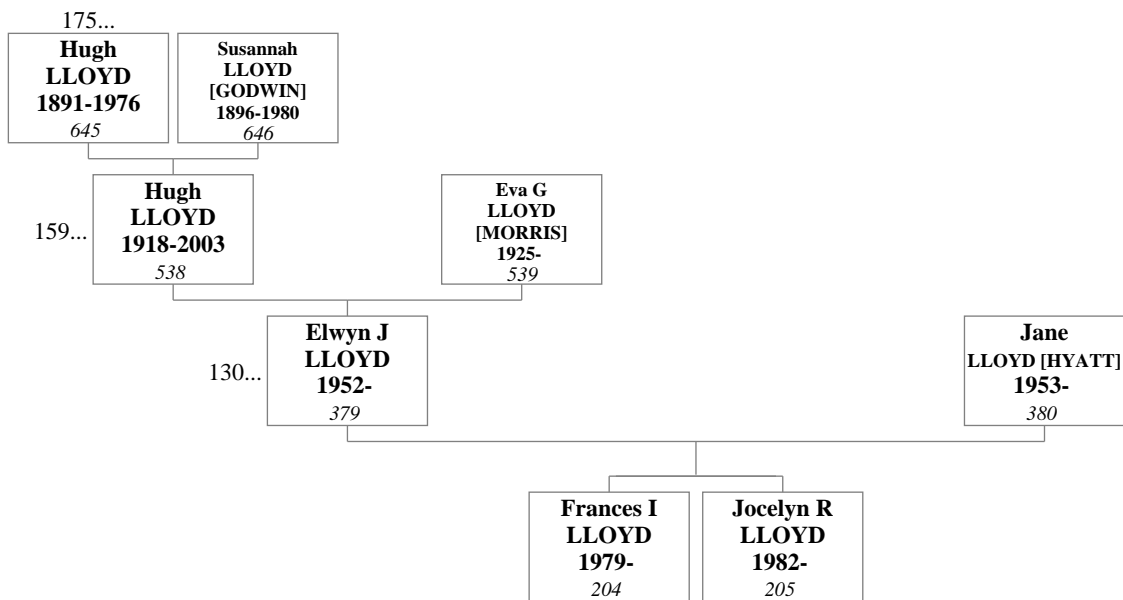

79. Ian PHILLIPS and Pamela PHILLIPS [SPAREY]

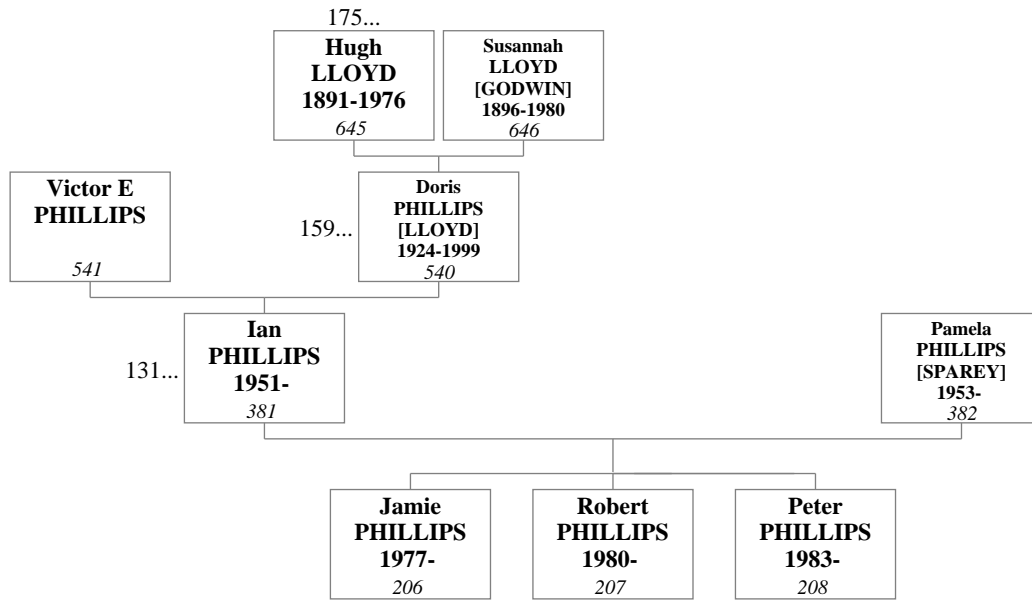

80. Colin PHILLIPS and Jane PHILLIPS [EDWARDS]

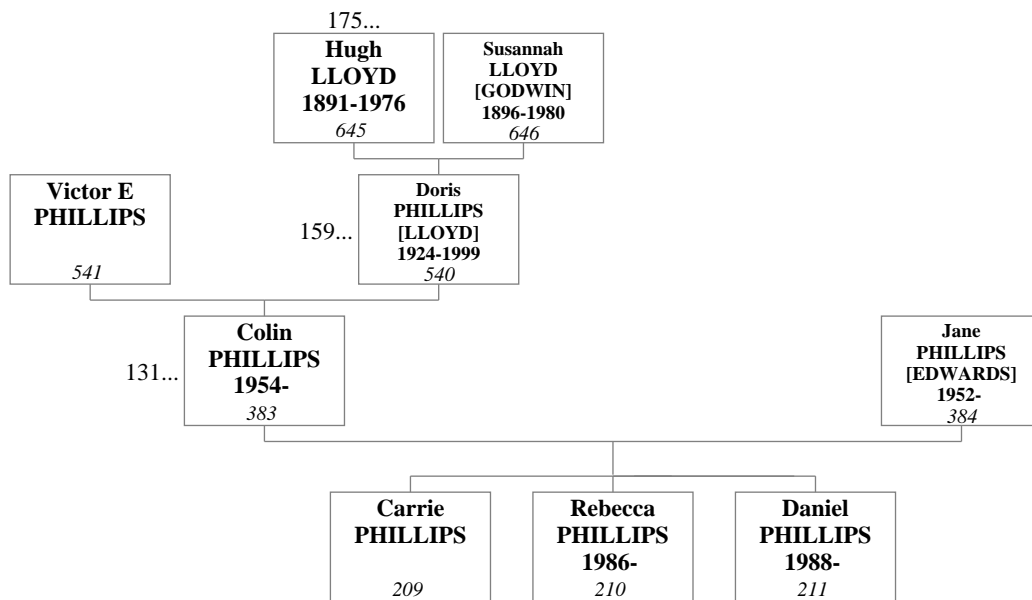

81. John H LEWIS and Lorraine LEWIS [PRICE]

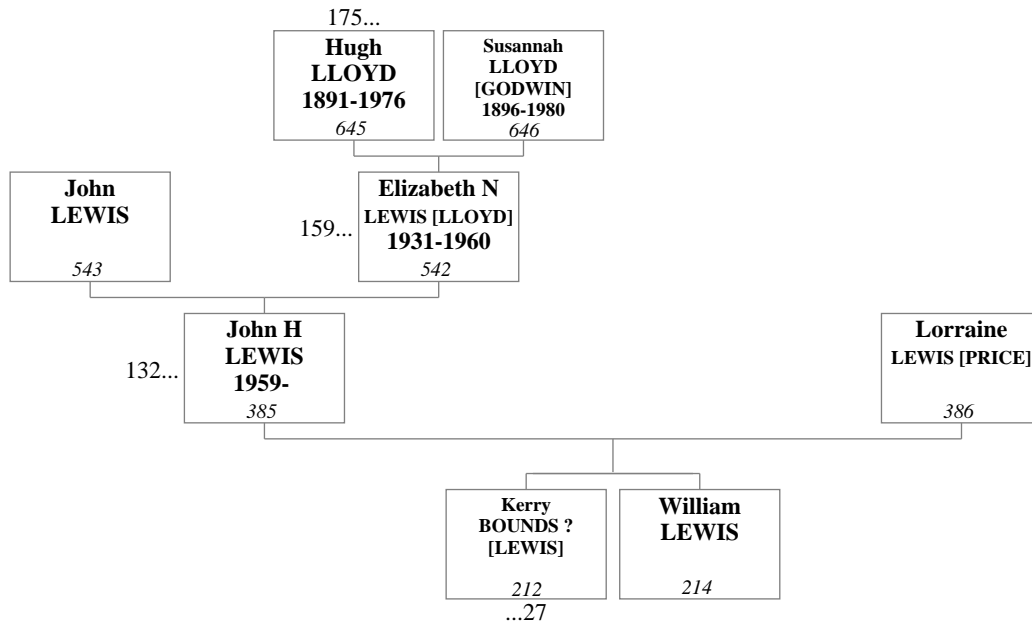

82. David WILLIAMS and Dawn WILLIAMS [PRICE]

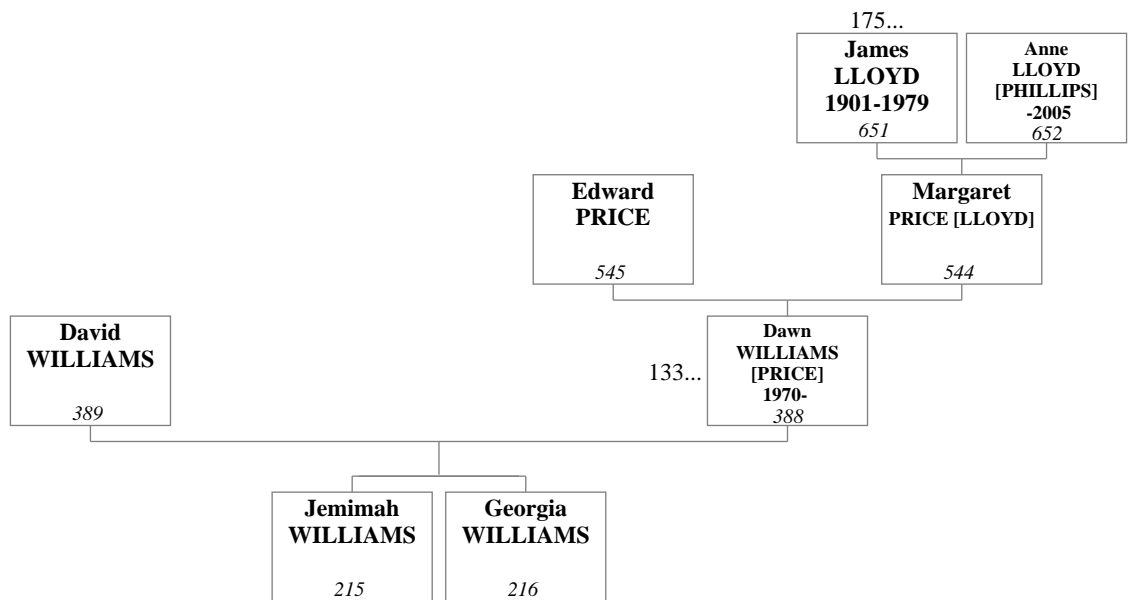

83. Richard BYWATER and Mary Elizabeth BYWATER [THOMAS]

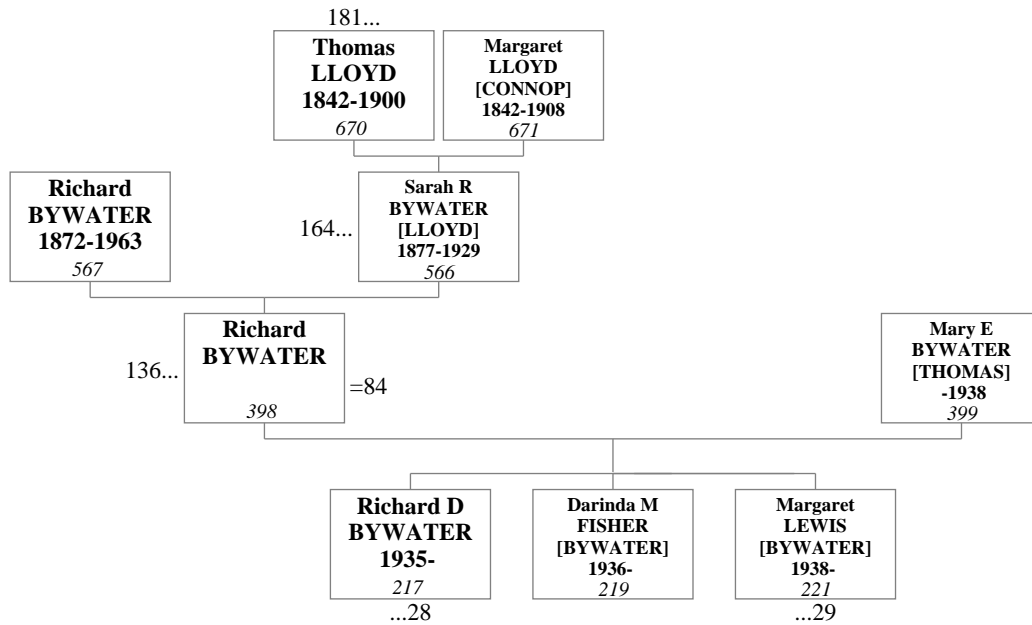

84. Richard BYWATER and Phyllis BYWATER [ELLIS]

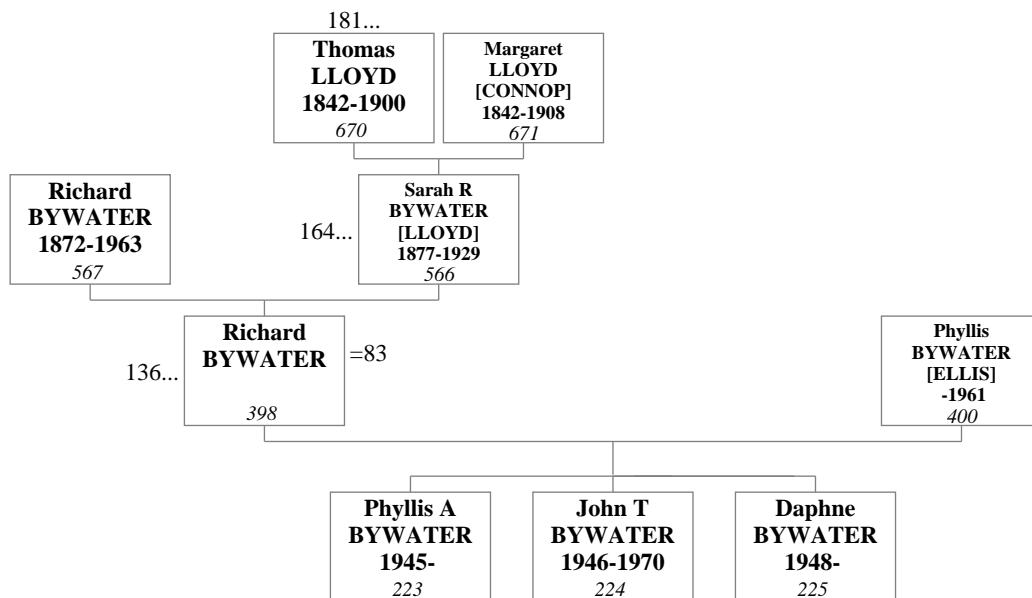

85. Caleb James BYWATER and Doris BYWATER [WATKINS]

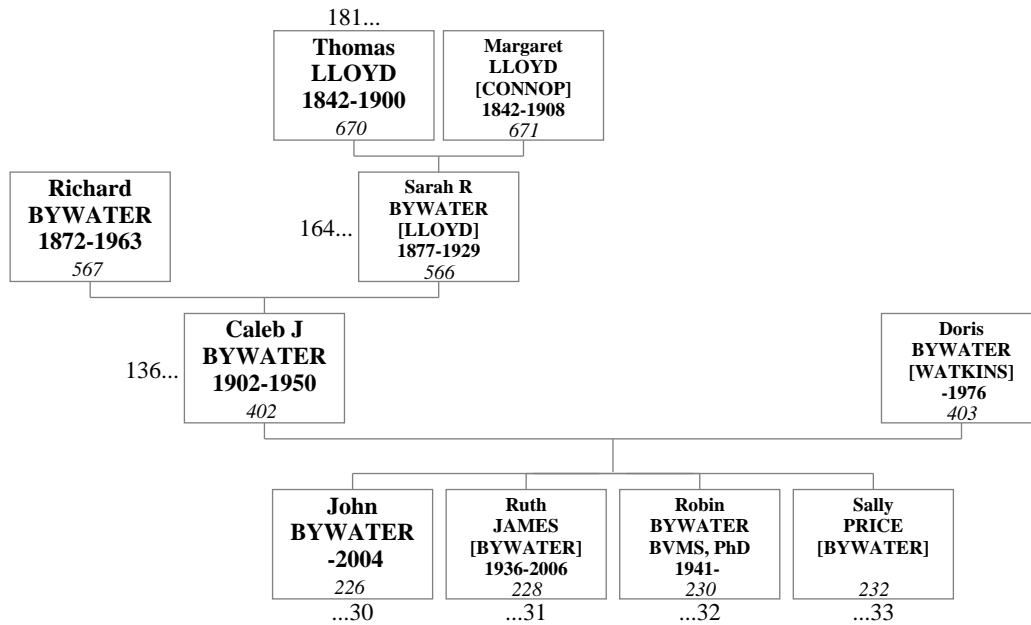

86. John (aka Jack) BYWATER and Edith BYWATER [DAVIES]

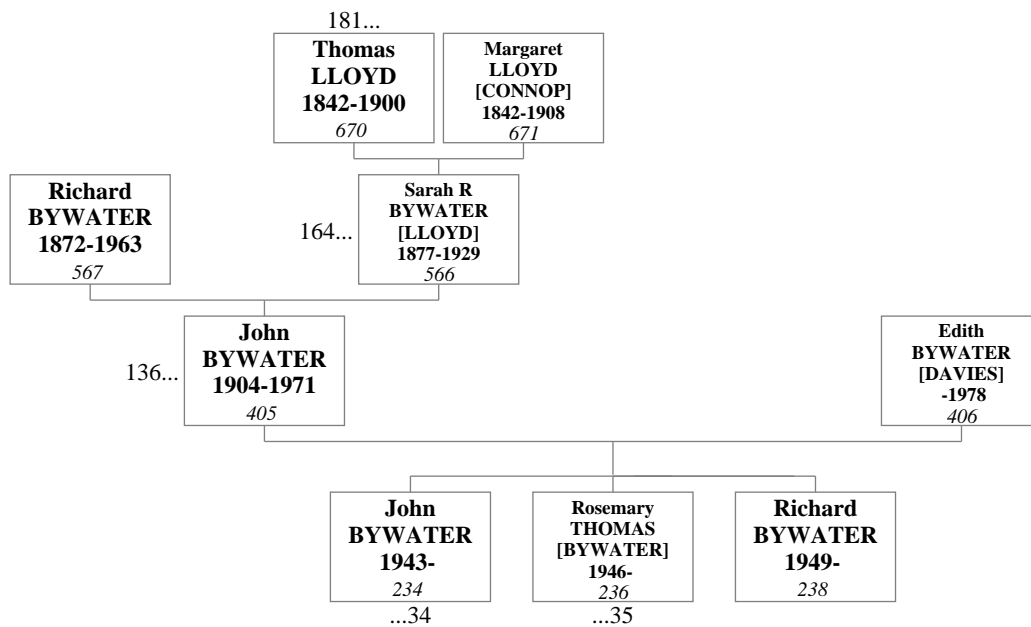

87. Ira MORRIS RAF and Naomi MORRIS [BYWATER]

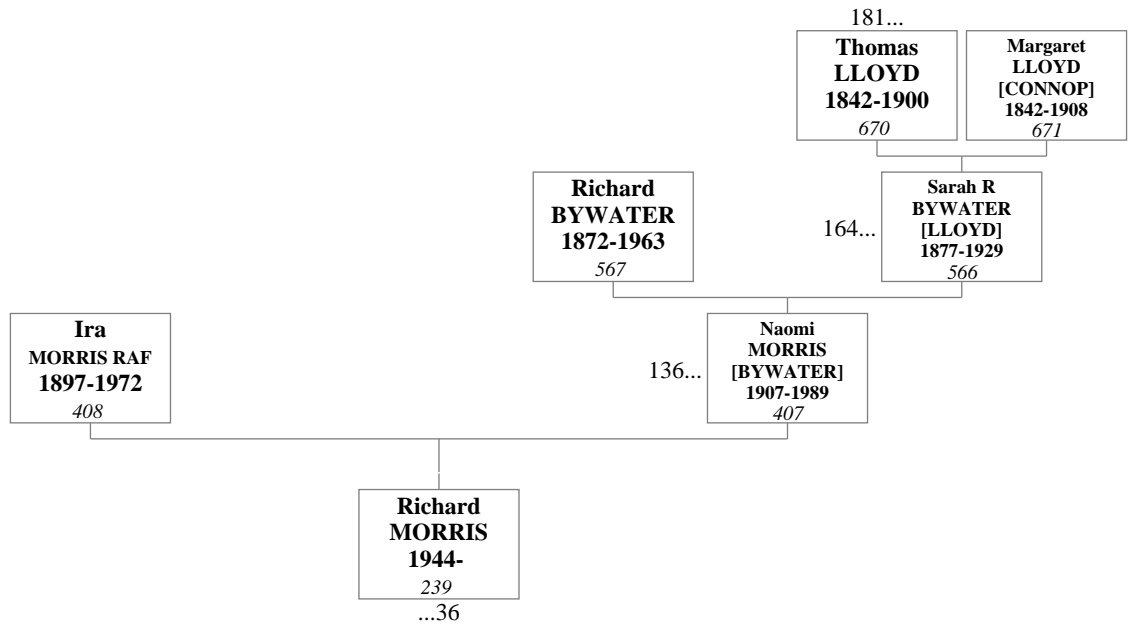

88. Thomas BYWATER and Ishobel BYWATER [McLELLAN MILLAR]

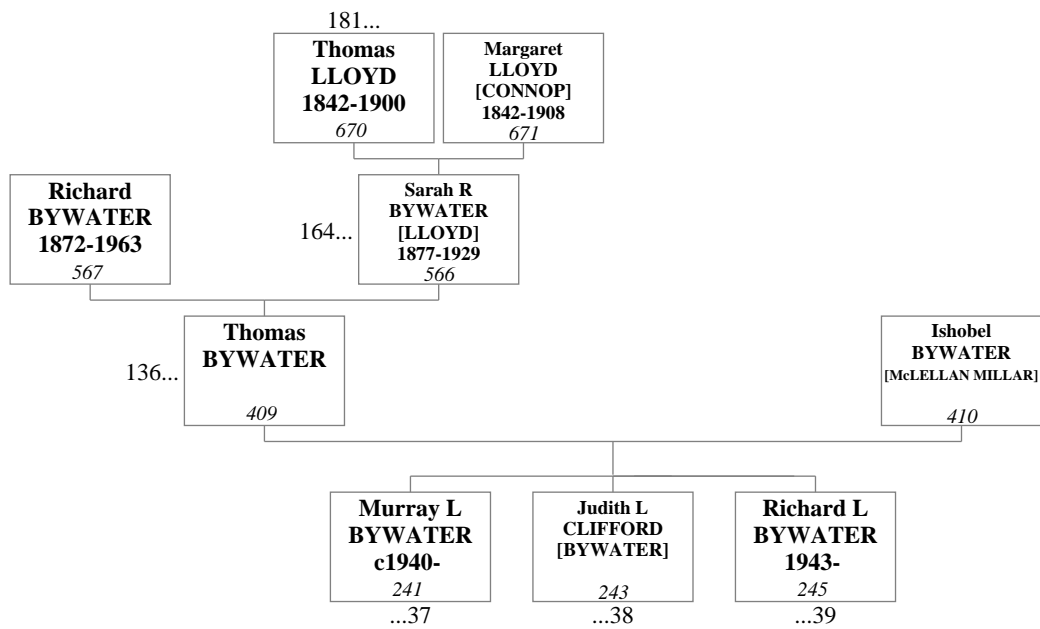

89. Robert David BYWATER and Mary BYWATER [NOTT]

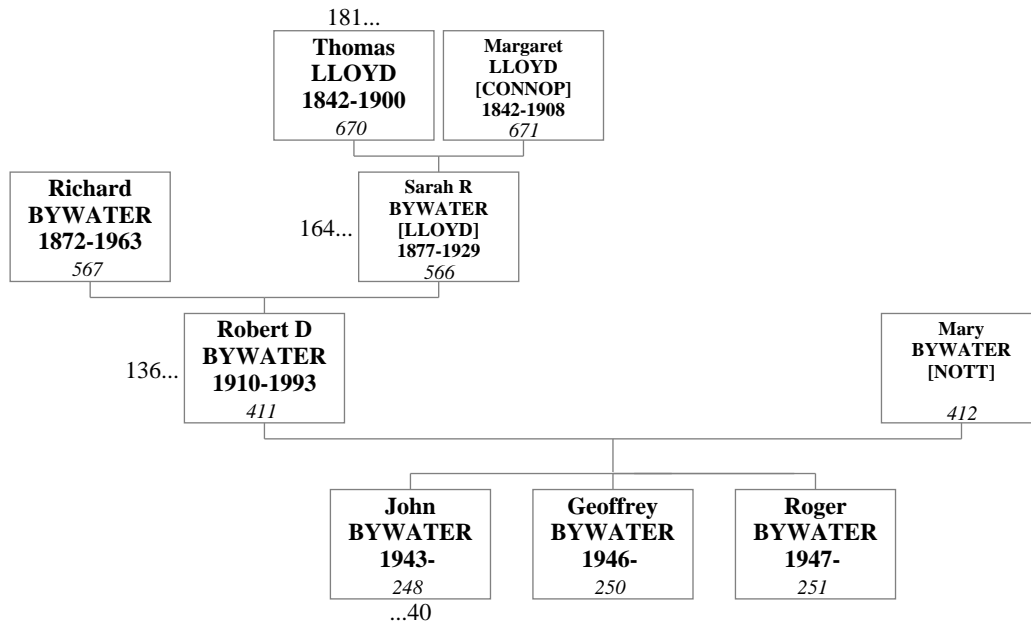

90. Edward HARRIS and Joyce Sarah HARRIS [BYWATER]

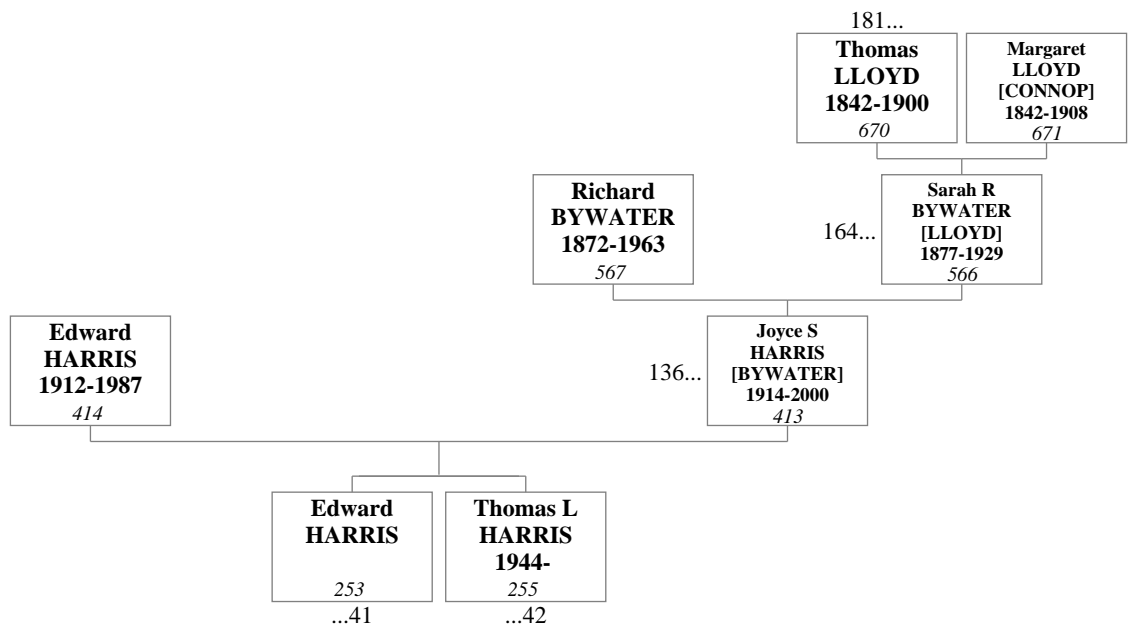

91. Trevor Glyn DAVIES and Constance Minnie DAVIES [BYWATER]

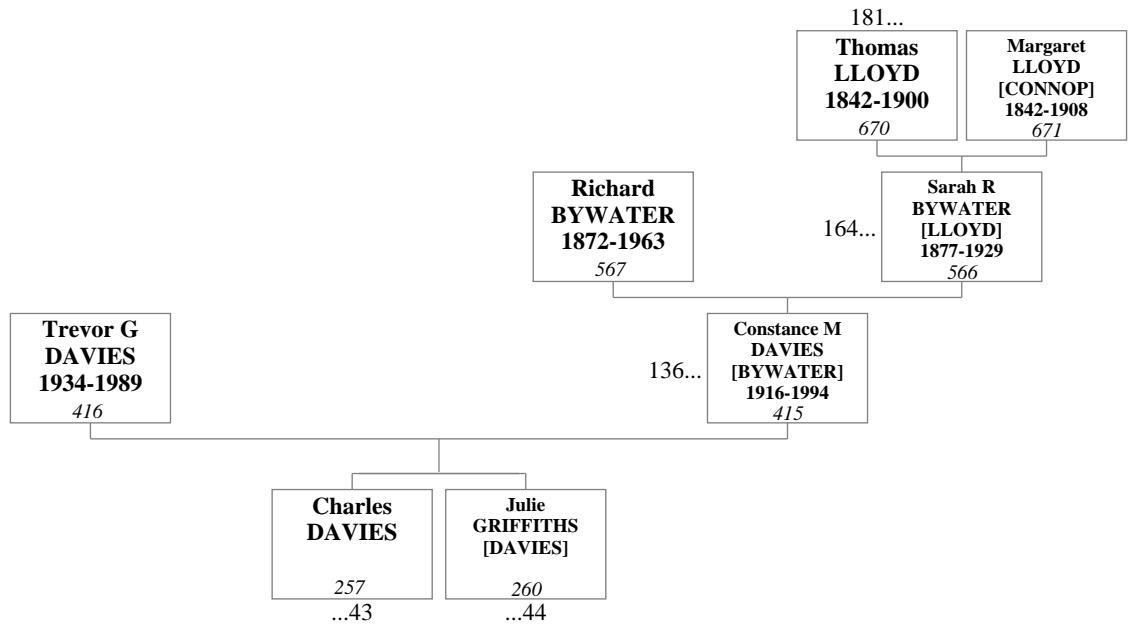

92. William Thomas ROBERTS and Doris ROBERTS [MASON]

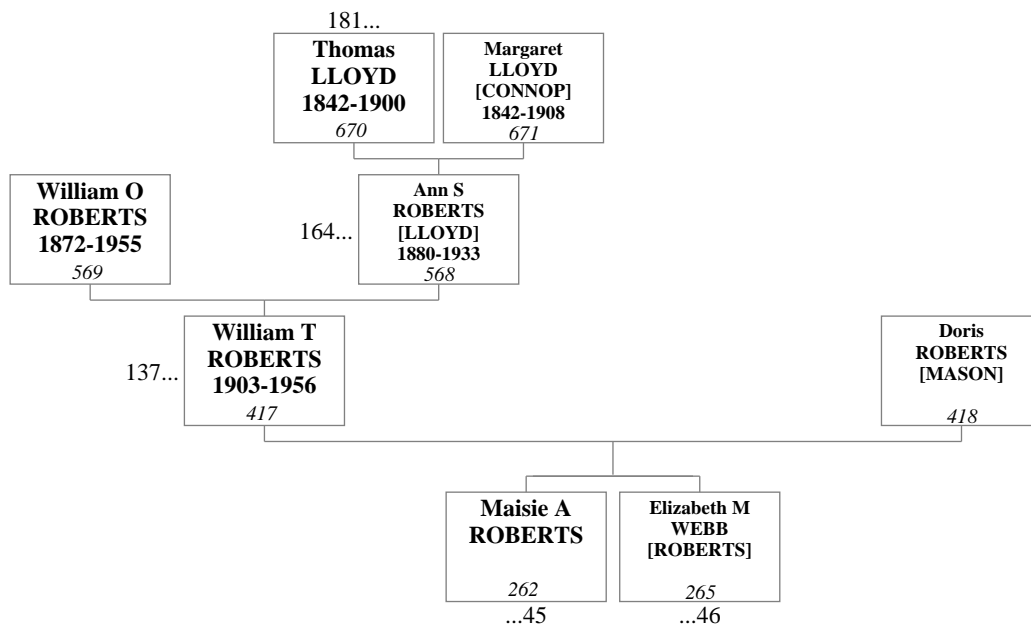

93. James Albert ROBERTS and Annie ROBERTS [WILLIAMS]

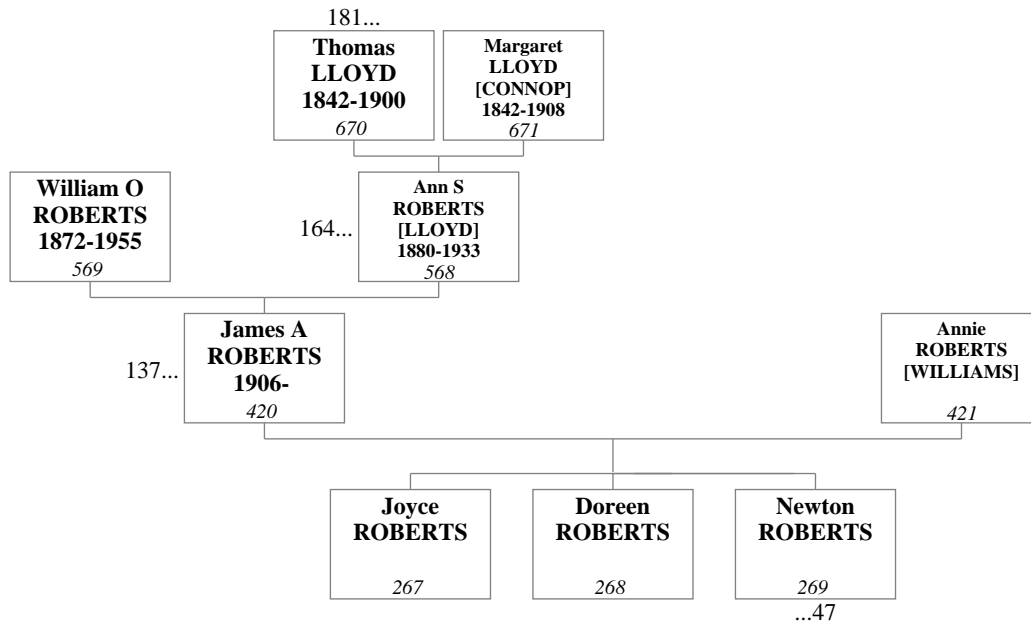

94. William Caleb ROBERTS and Mona A ROBERTS [PLAIN]

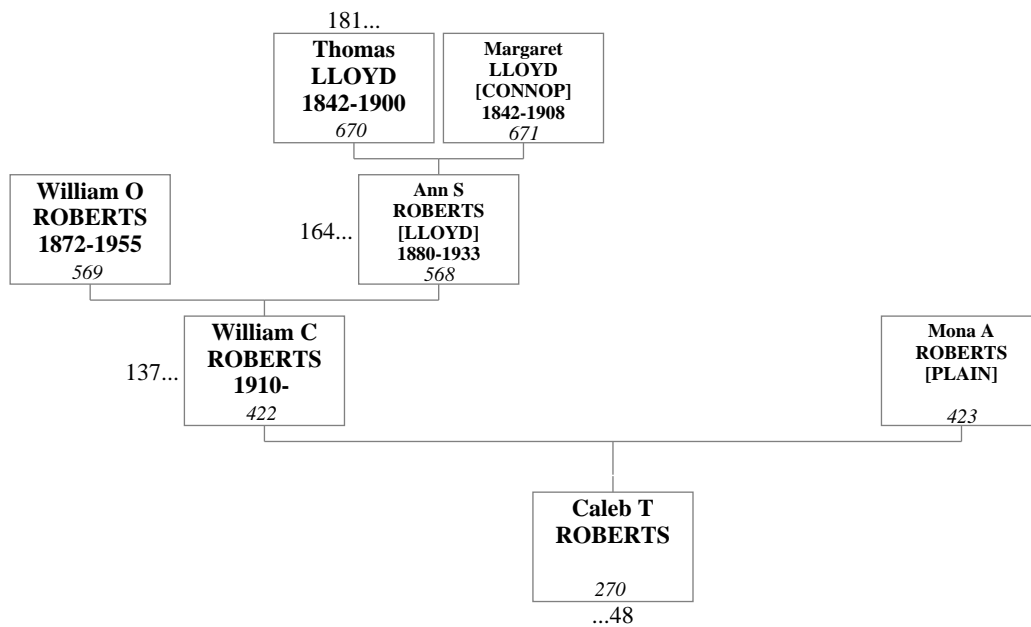

95. Muriel Annie (Dolly) LLOYD

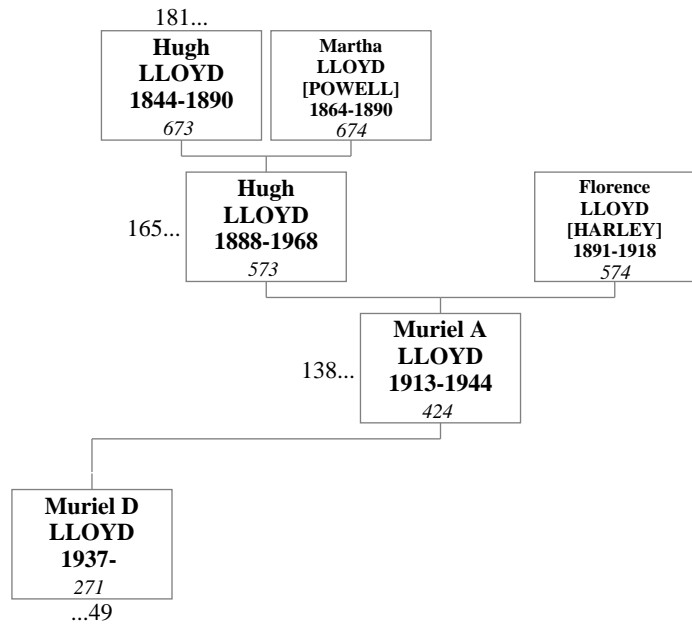

96. Mr. PICKERSGILL and Gwendoline Dilys PICKERSGILL [LLOYD]

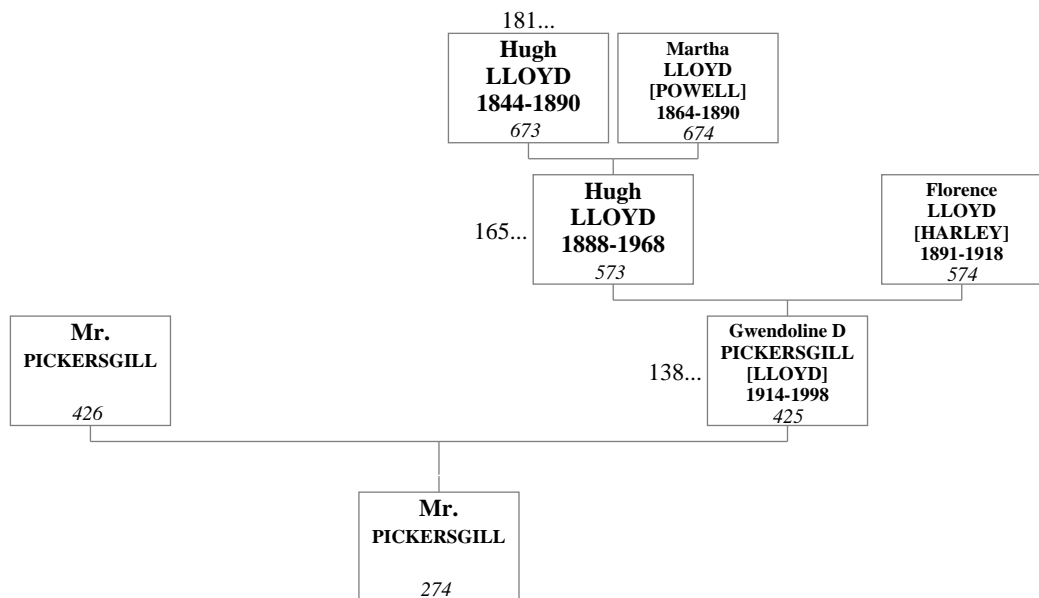

97. Mr. TAIT and Kathleen Florence Martha TAIT [LLOYD]

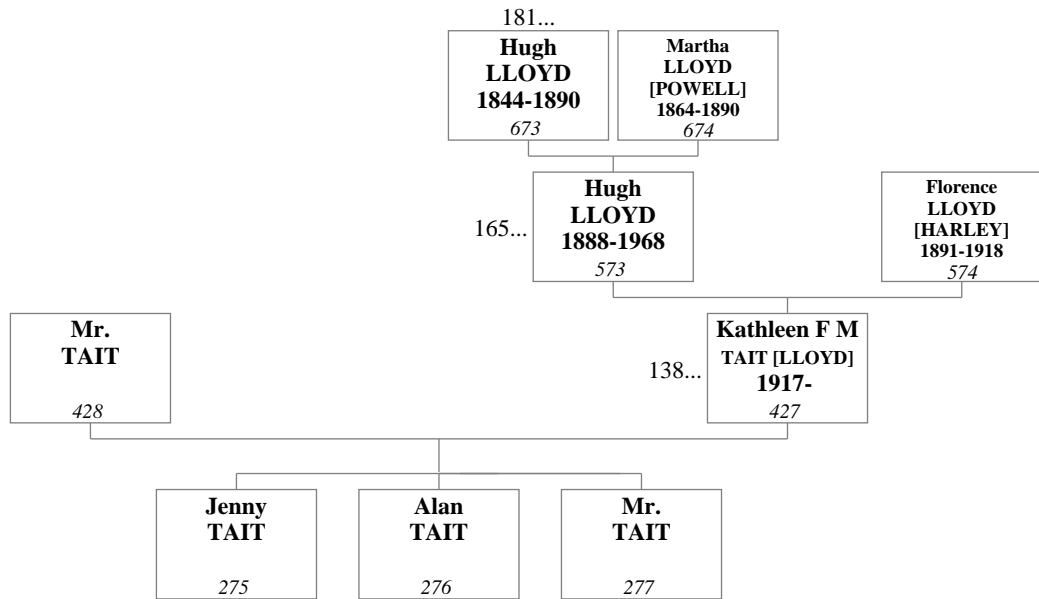

98. Mr. HARRIS and Margaret Maisie HARRIS [LLOYD]

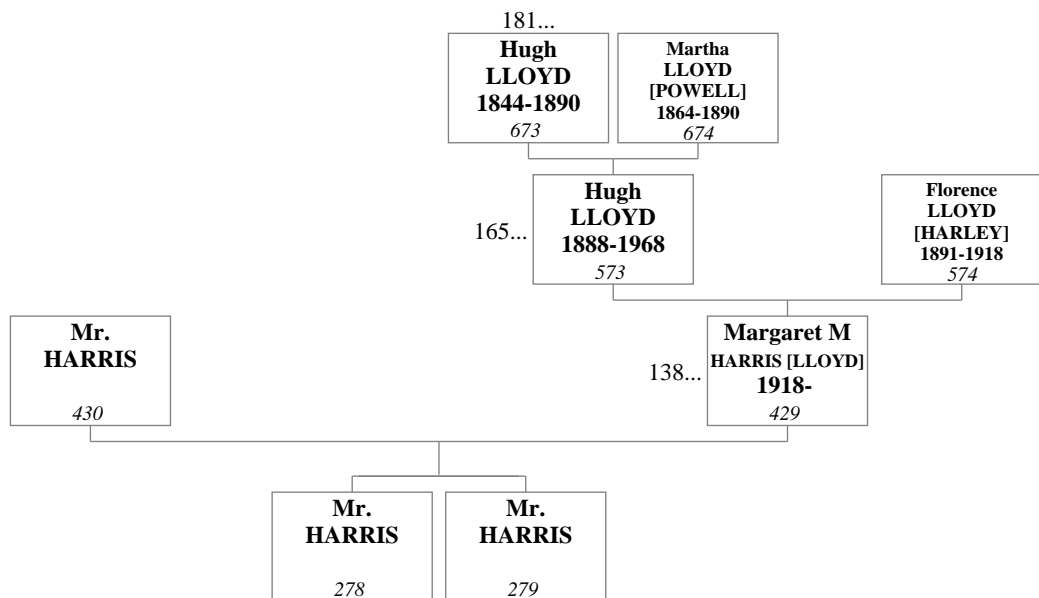

99. Mr. DAVIES and Mercia Willoughby DAVIES [LLOYD]

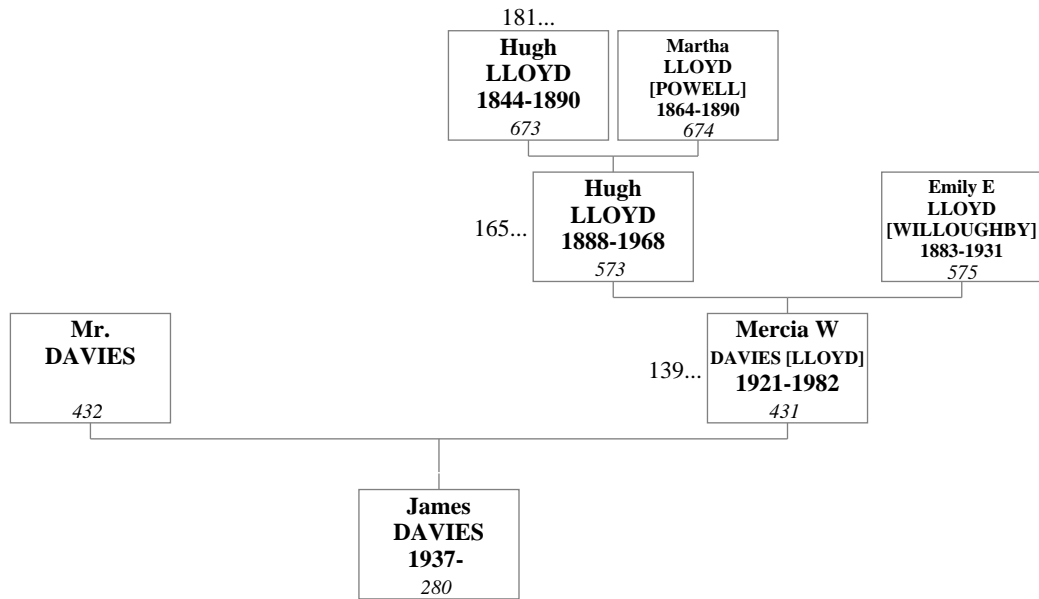

100. Herbert Arthur LLOYD - STEPHENS and Alma LLOYD - STEPHENS [SYMES]

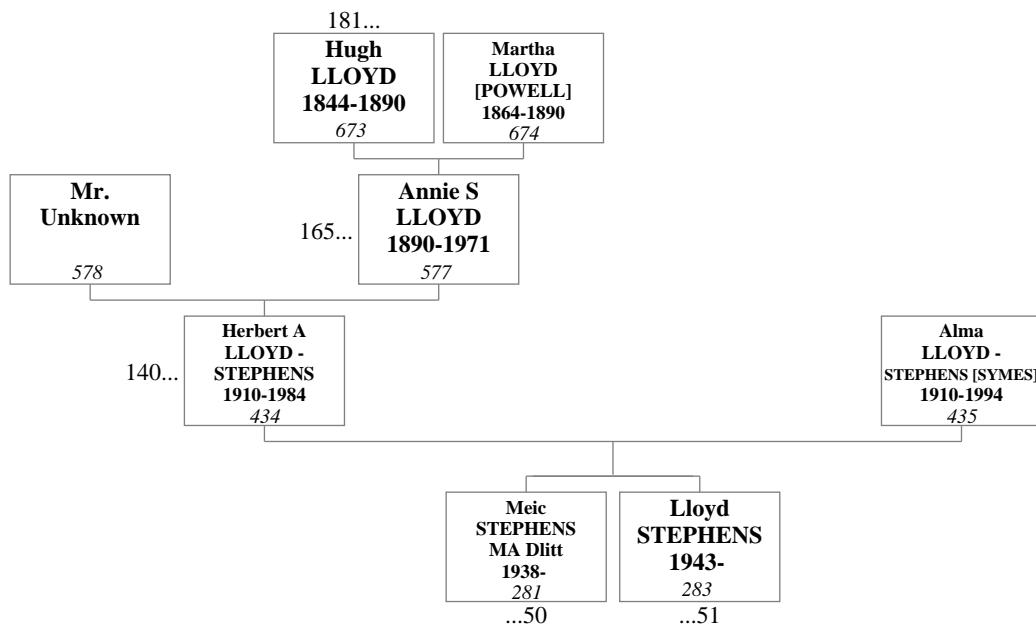

101. Aubrey PRITCHETT and Annie Matilda (Nan) PRITCHETT [EVES]

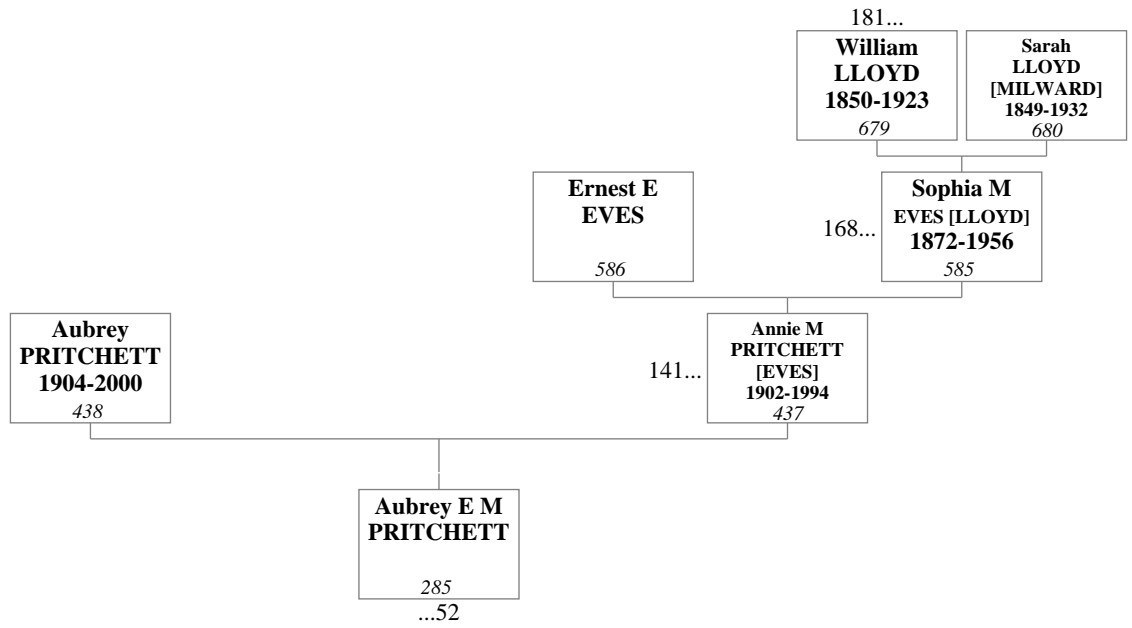

102. Tom Evan LANE and Irene LANE [BALLINGER]

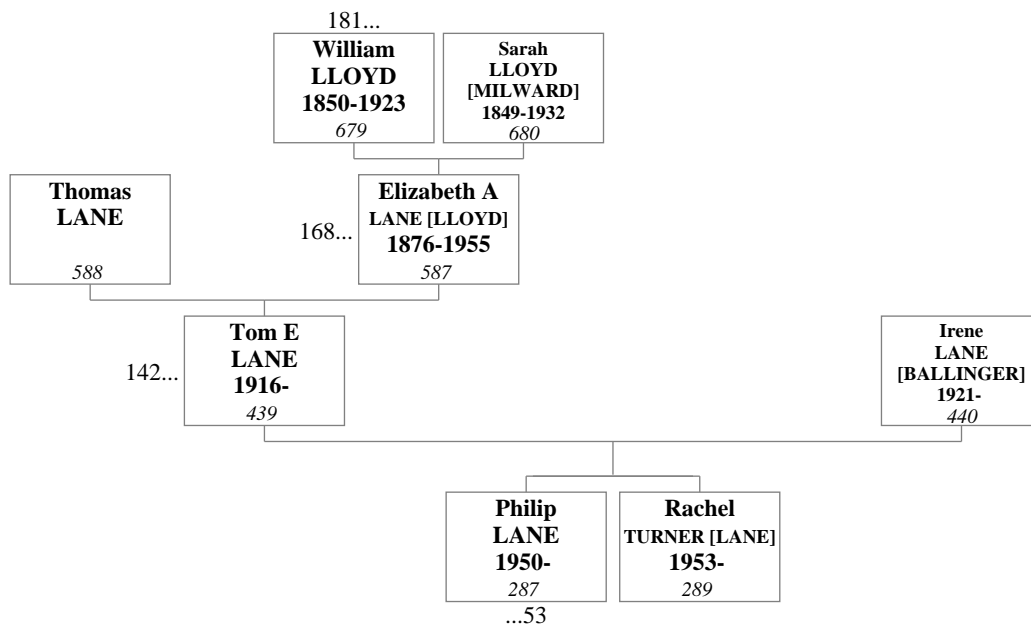

103. John LLOYD and Beryl Kathryn LLOYD [MILLER]

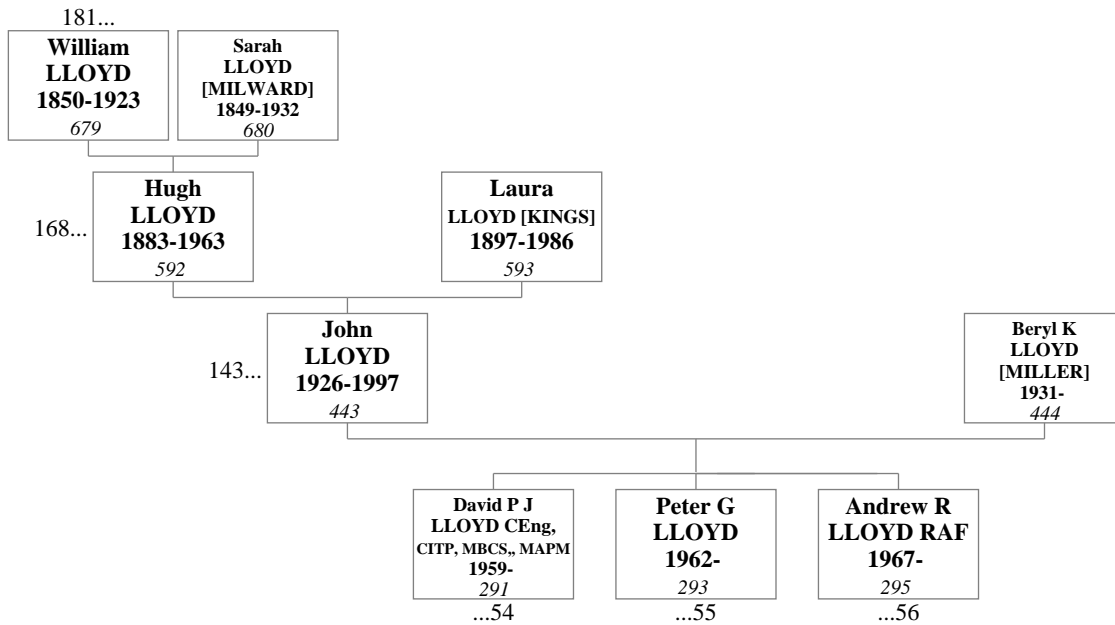

104. Raymond George (Bill) BOWS BA and Annie Mabel (Nancy) BOWS [LLOYD] BA

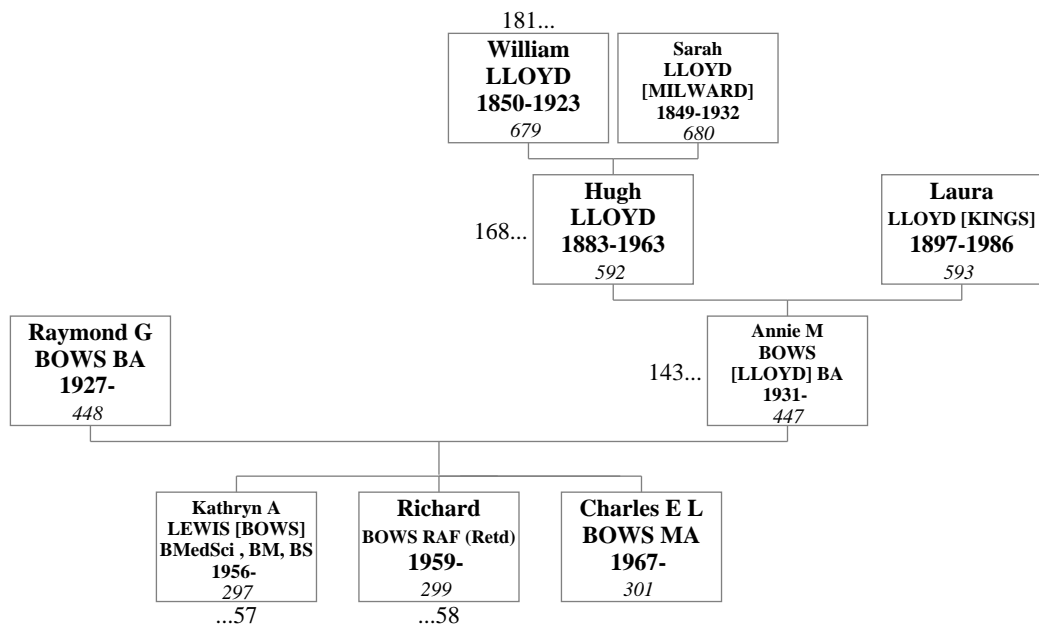

105. David Kingsley LLOYD and Susan M LLOYD [MURRAY]

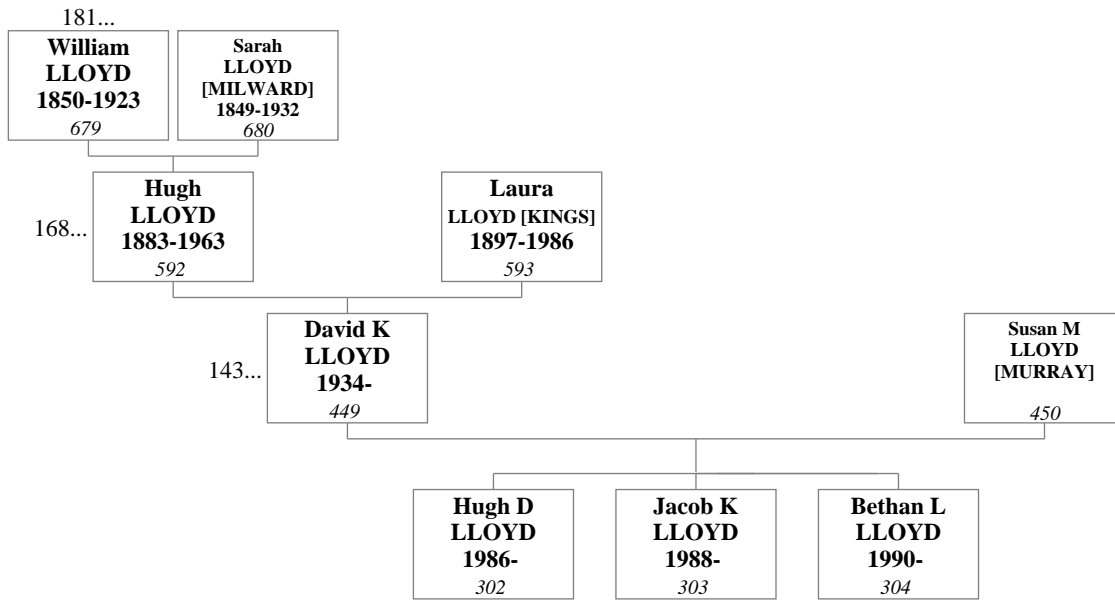

106. Tom HARDWICK and Kathleen HARDWICK [LLOYD]

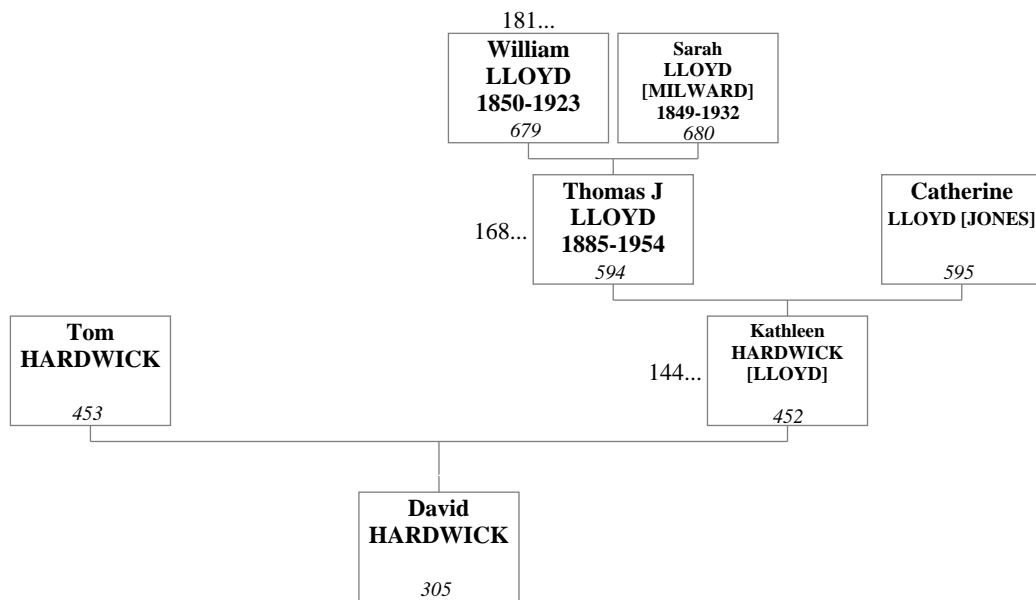

107. Sidney Walter Gordon LLOYD and Peggy LLOYD [SIMMONS]

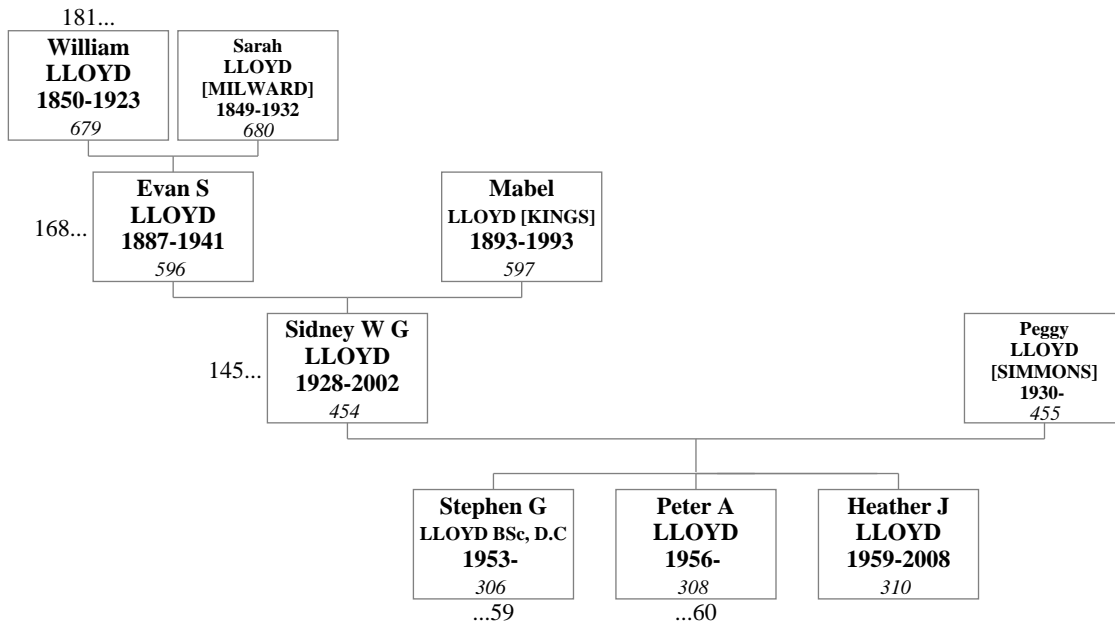

108. John Arthur STRATTON and Hannah Heslop STRATTON [MACAULAY]

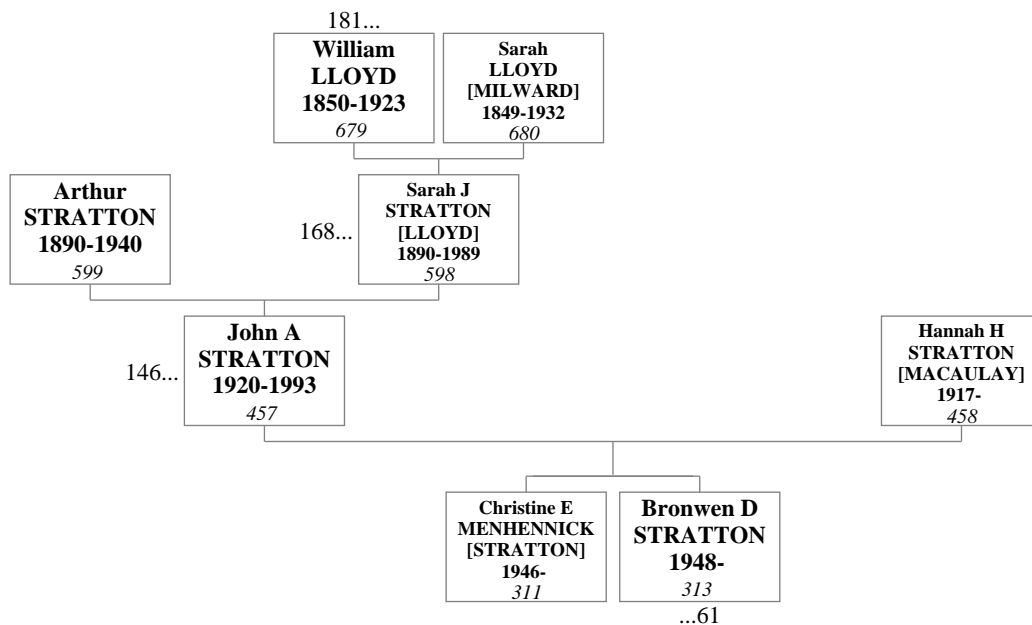

109. Robert Owen ROBERTS and Edith Megan ROBERTS [STRATTON]

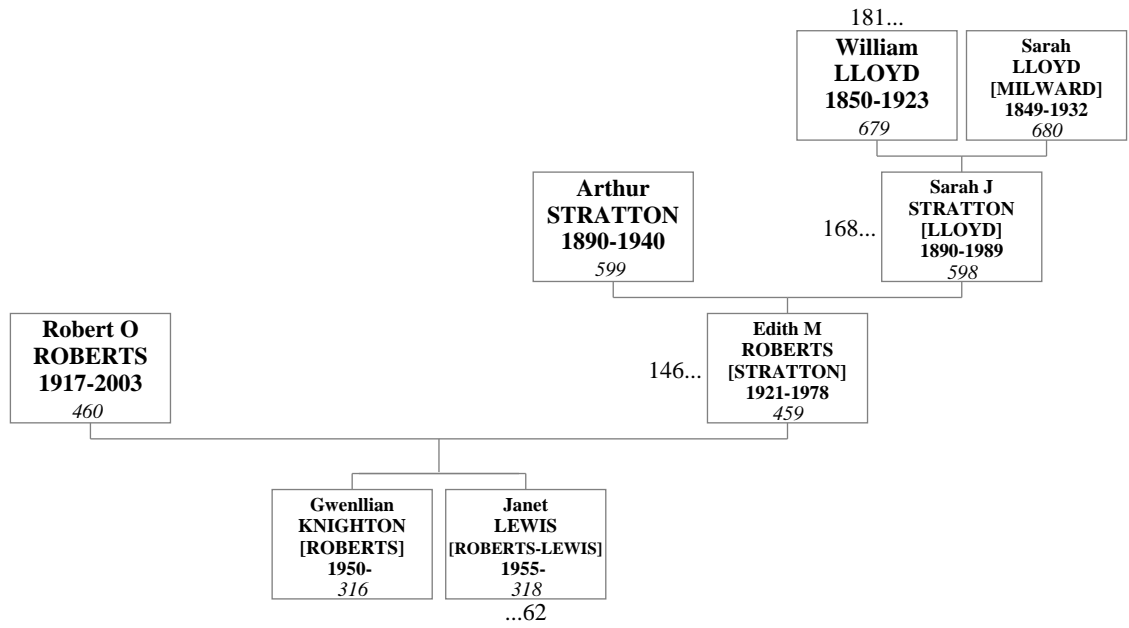

110. Harold Henry JONES and Dorothy May JONES [POWELL]

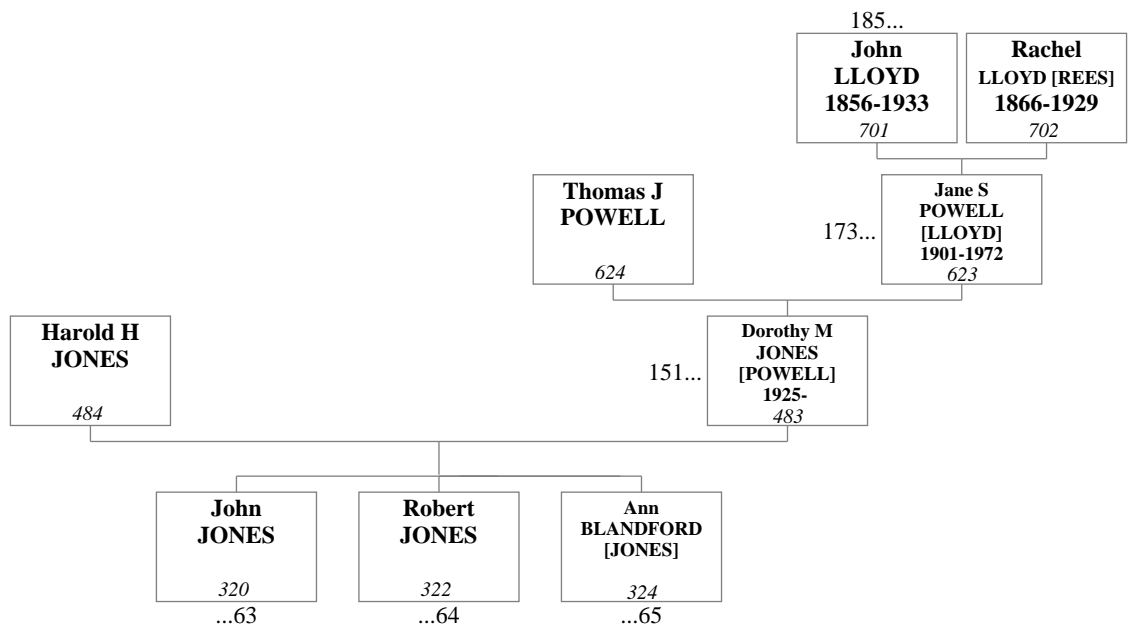

111. George James INGRAM and Gwendoline Jane (Babs) INGRAM [POWELL]

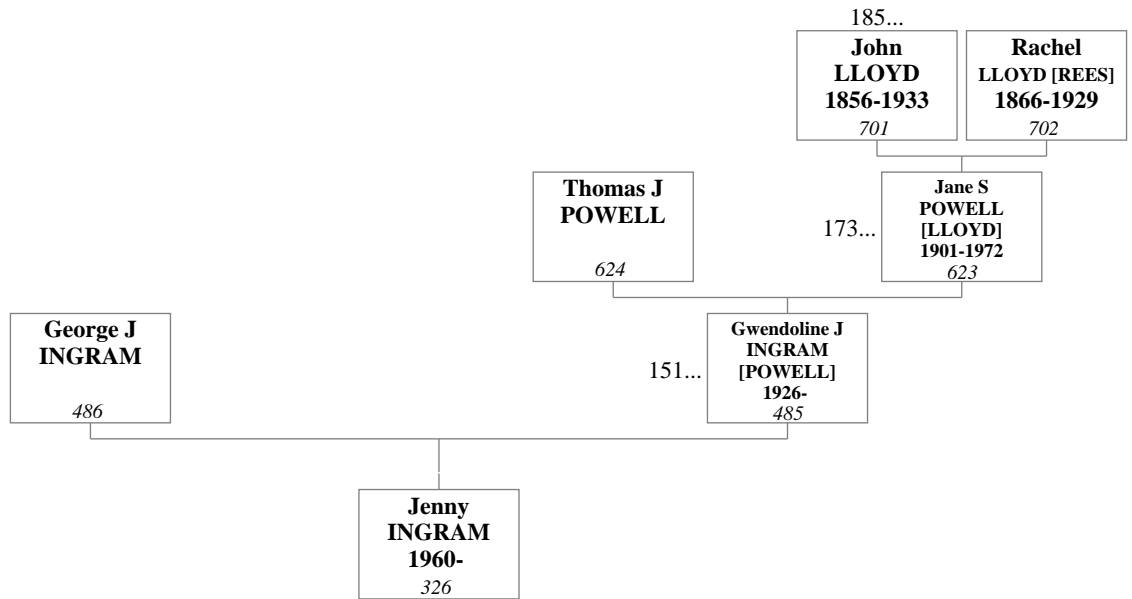

112. Thomas John POWELL and Enid POWELL [GORE]

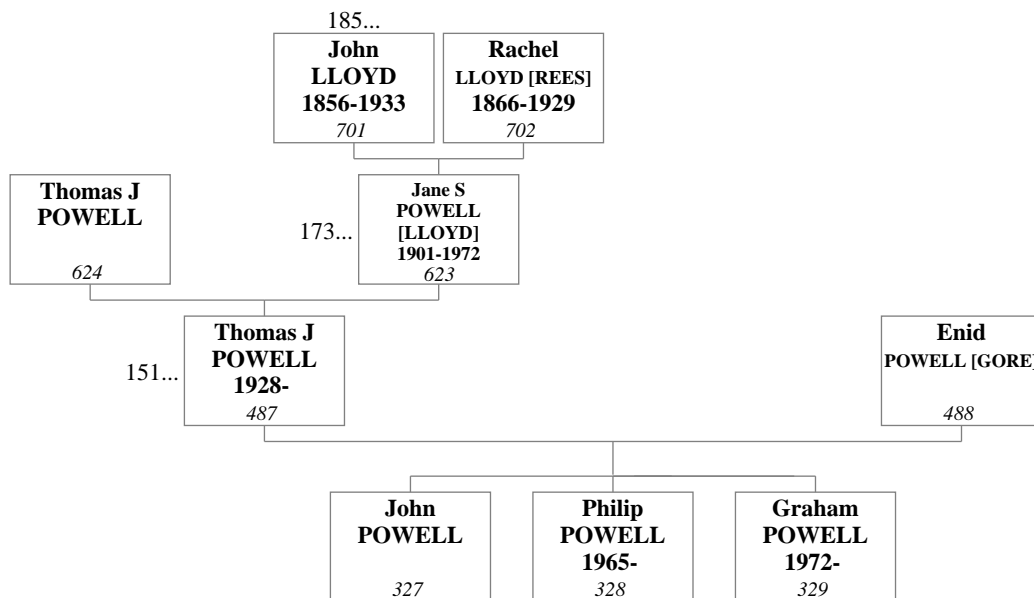

113. William Mervyn PRICE and Elizabeth Rachel PRICE [POWELL]

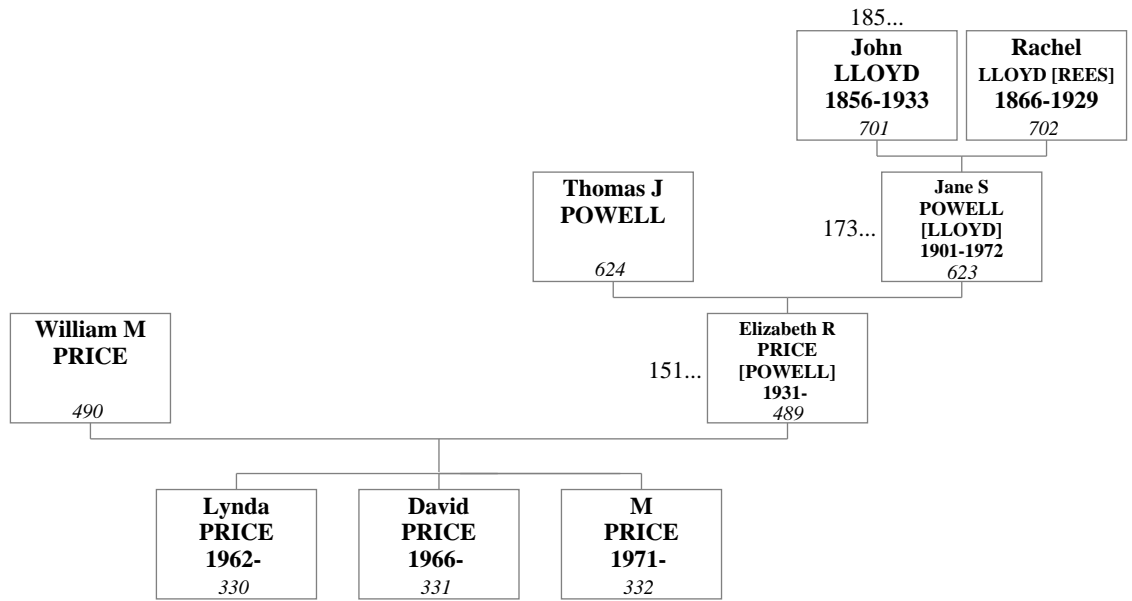

114. Kenneth Charles POWELL and Ruth POWELL [PUGH]

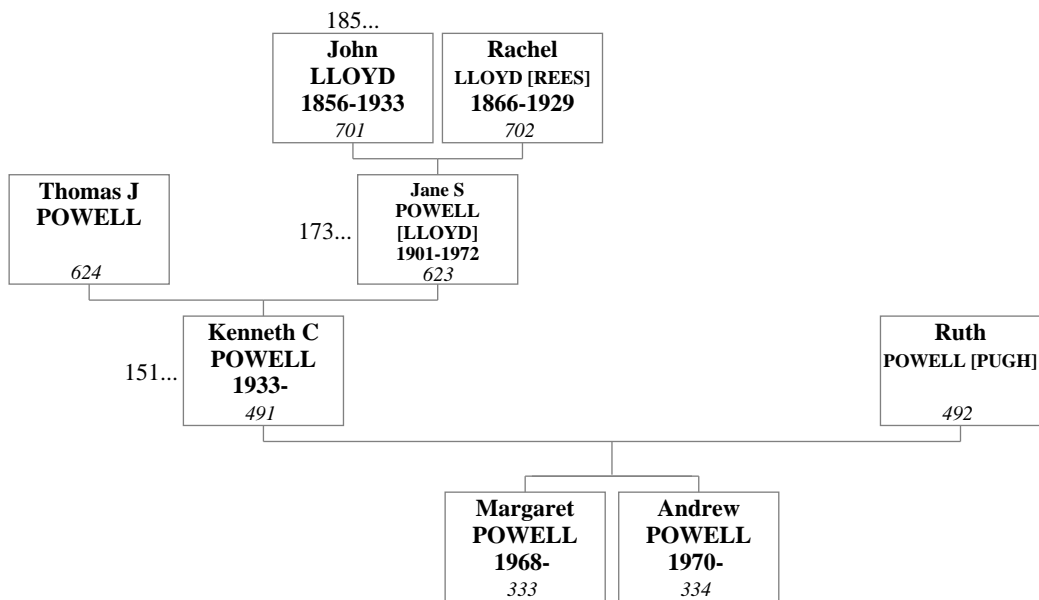

115. Jeffrey DAVIES and Edith Margaret DAVIES [POWELL]

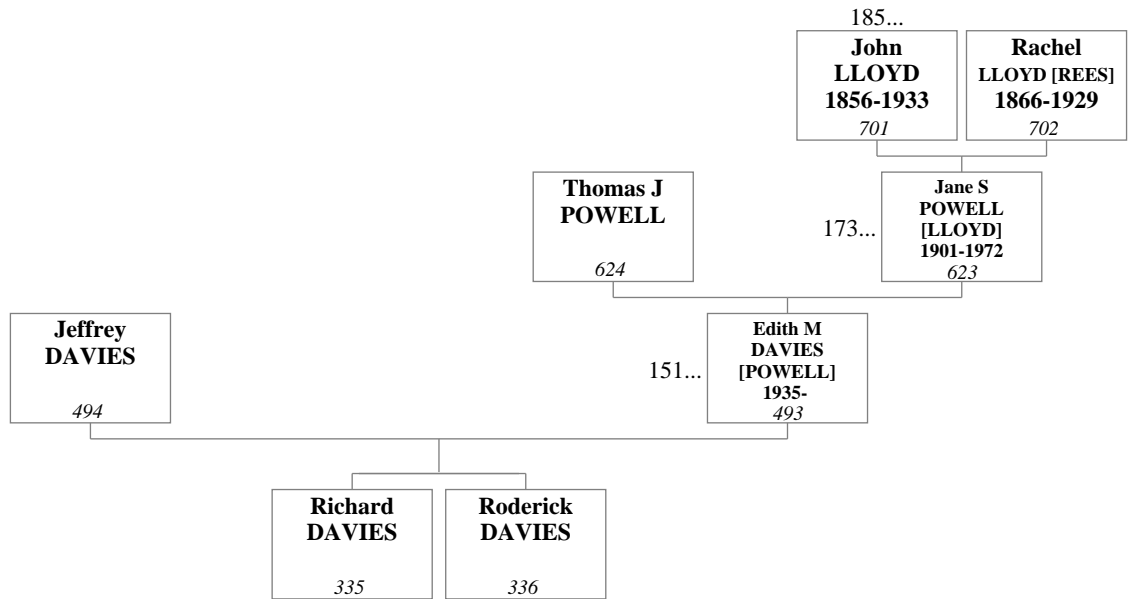

116. Eithel Pugh POWELL and Lena Mary POWELL

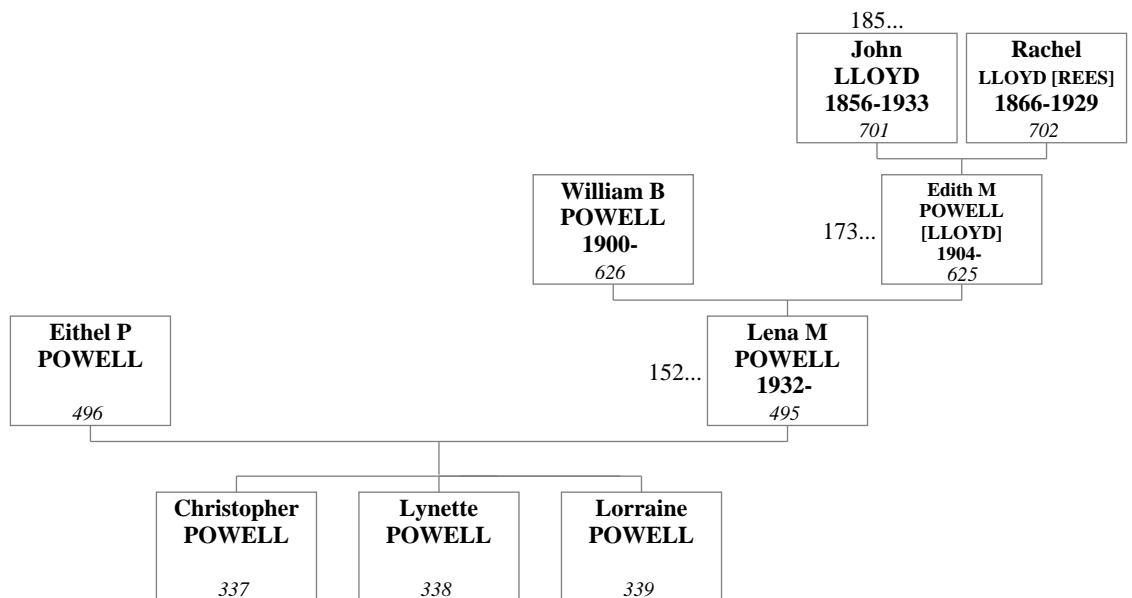

117. Gilbert Samuel BOWEN and Jeanette BOWEN [POWELL]

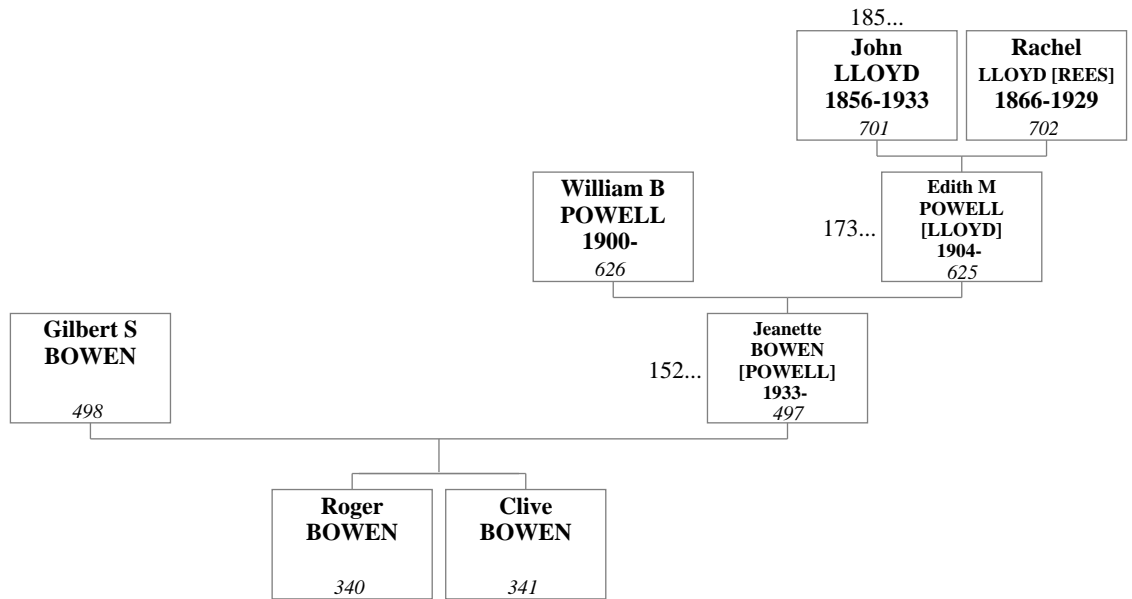

118. William Owen POWELL and Mary POWELL [LLOYD]

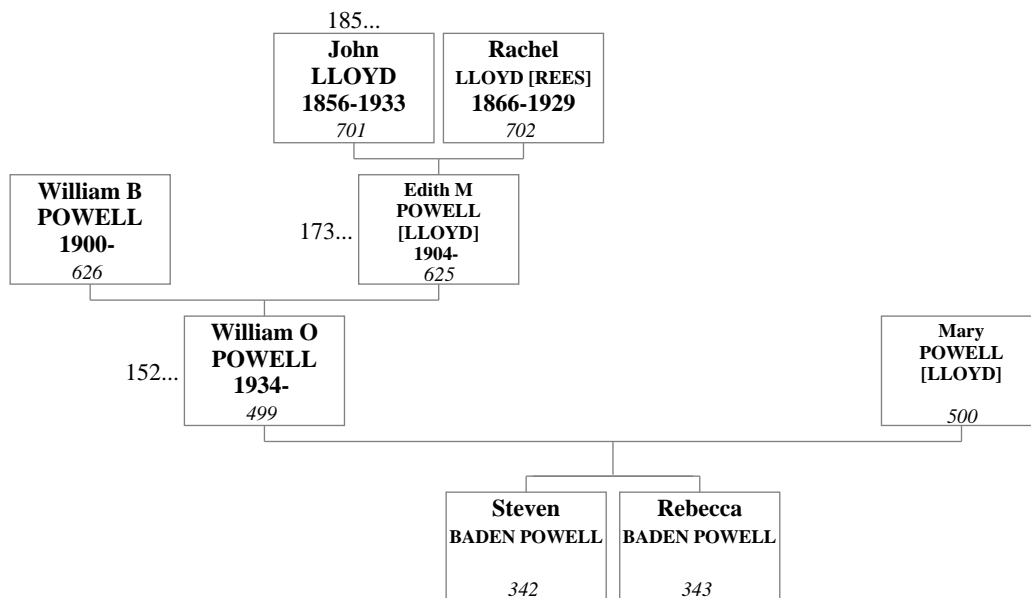

119. Robert Lloyd POWELL and Christine POWELL [LEWIS]

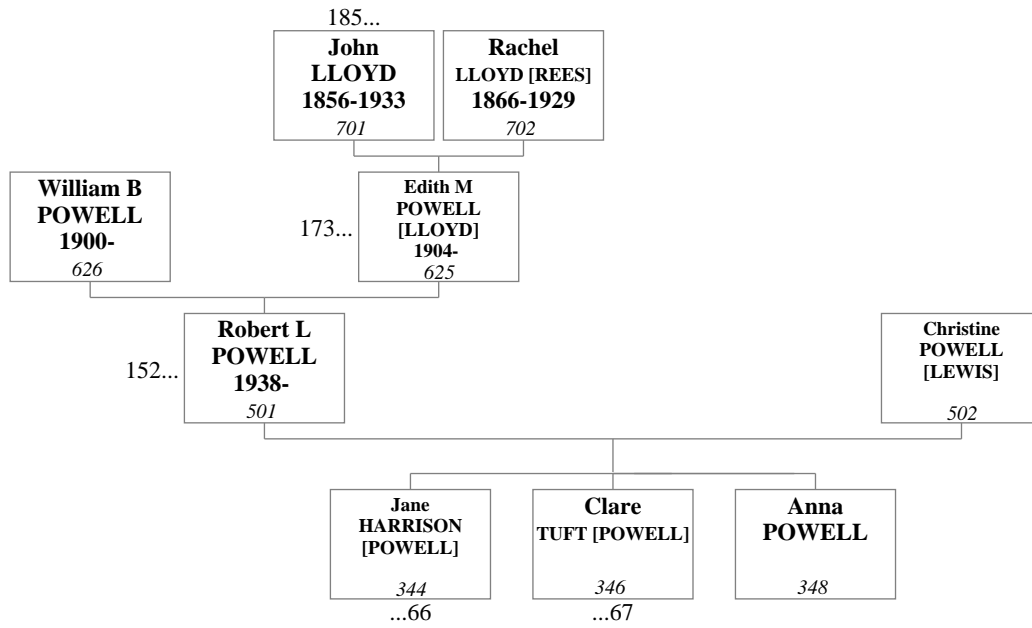

120. Derek ILES and Ms. ILES [POWELL]

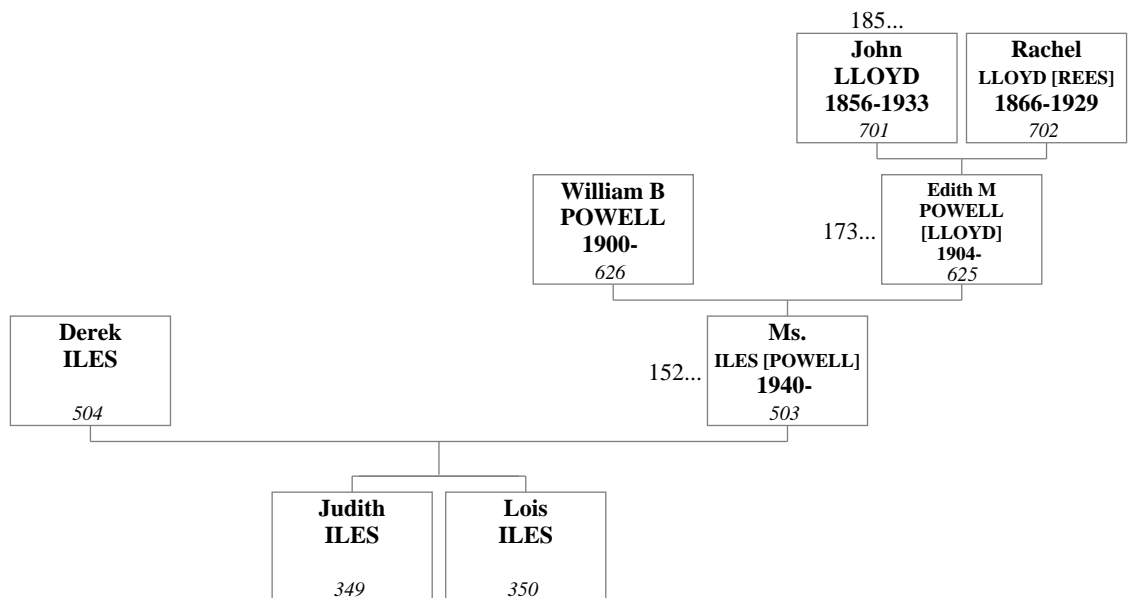

121. Sid WILLIAMS and Phyllis WILLIAMS [JAMES]

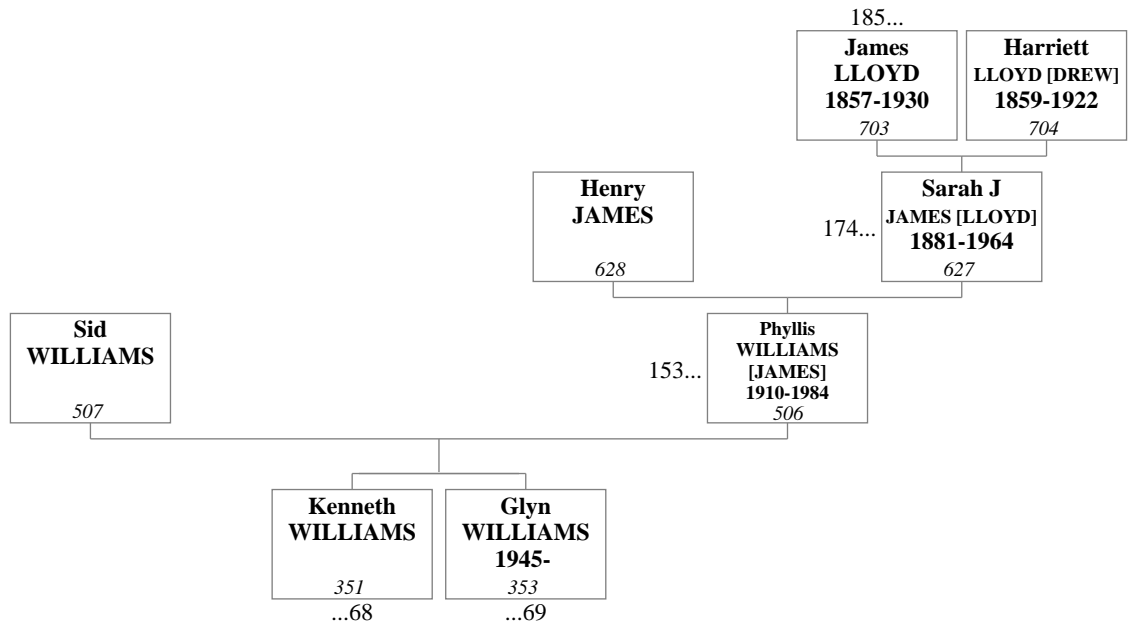

122. Mr. Unknown and Mary JAMES

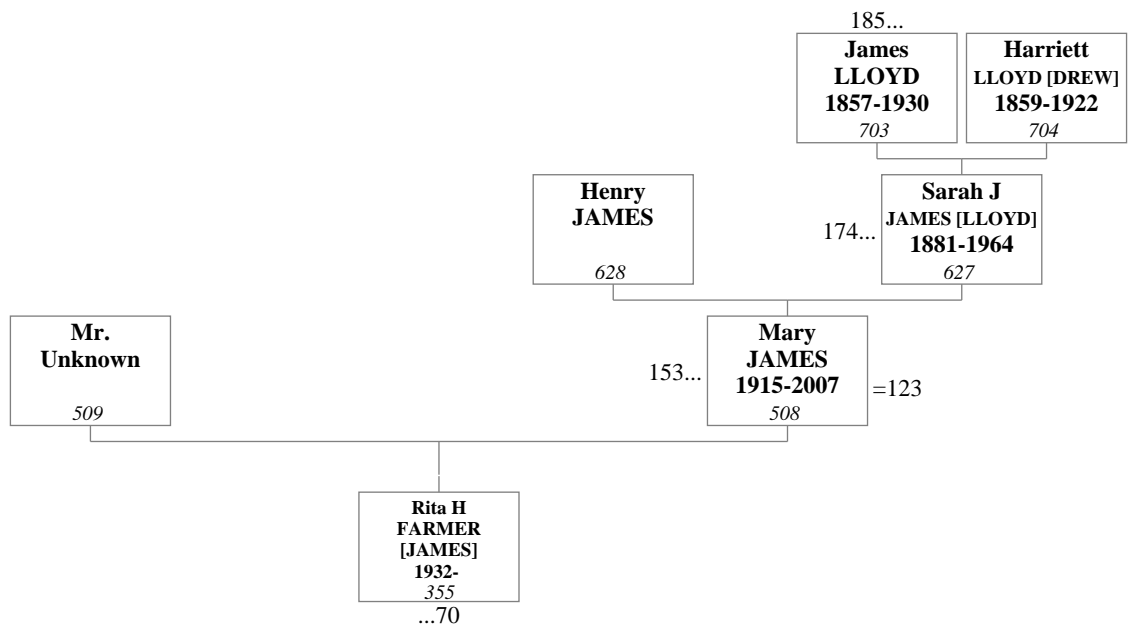

123. David LEWIS and Mary JAMES

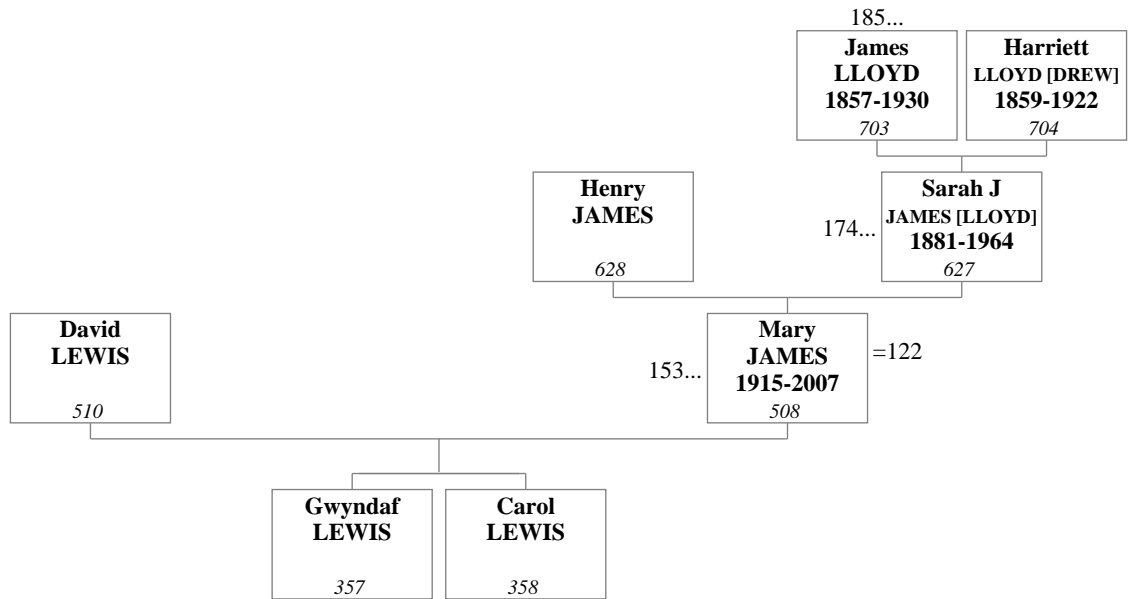

124. Thomas A MORGAN and Margeurite J MORGAN [JAMES]

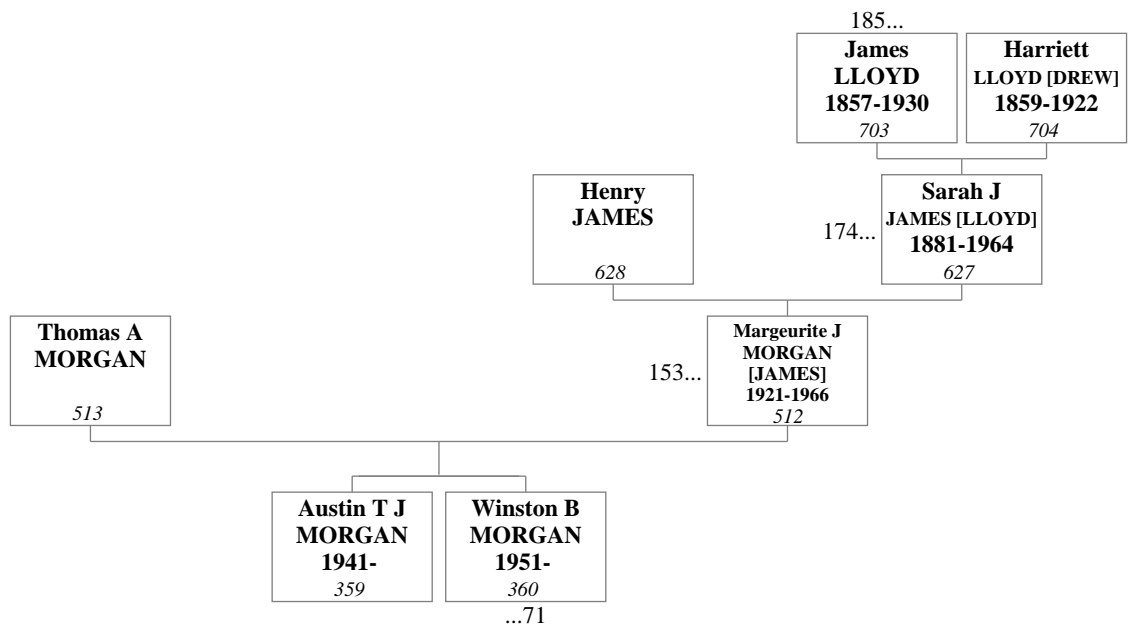

125. Walter LLOYD and Dorothy Clare LLOYD [DAVIES]

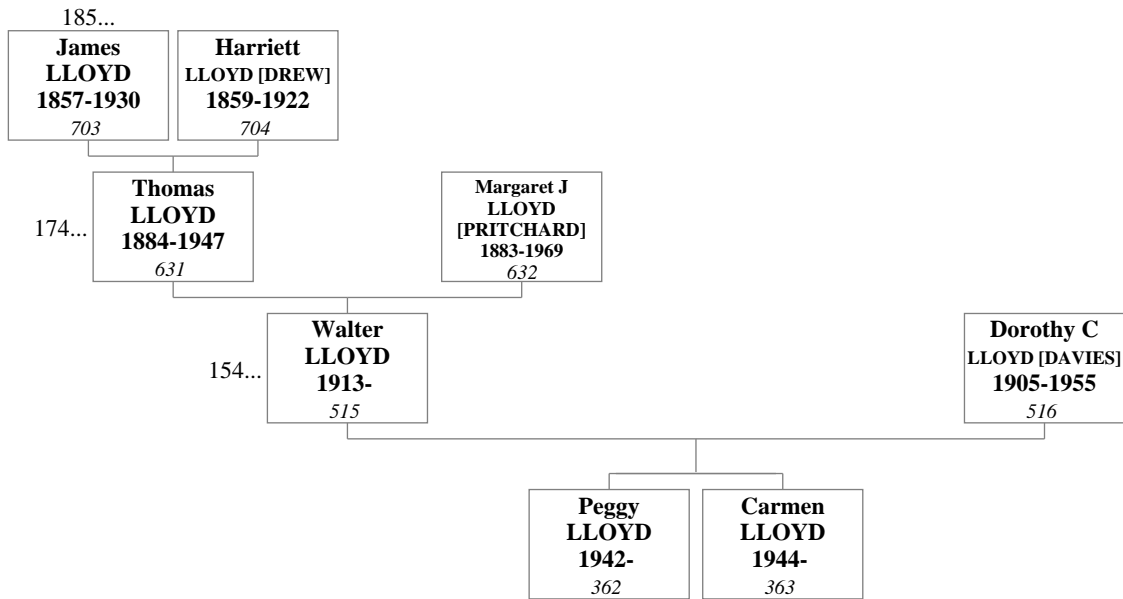

126. John (Jack) E DUGGAN and Emily Maud DUGGAN [LLOYD]

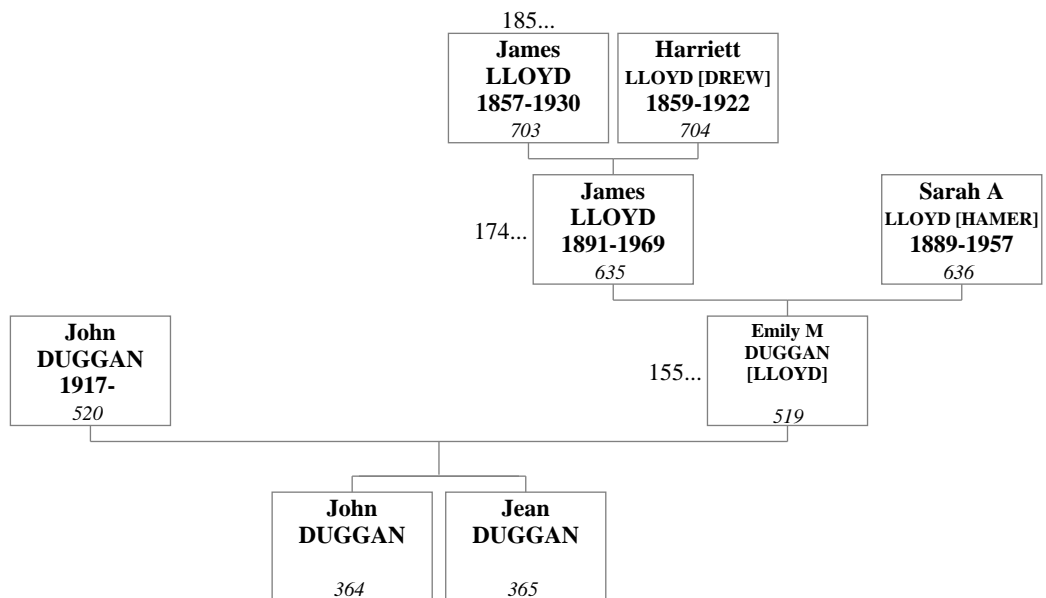

127. Evan Rice LLOYD and Hilda LLOYD

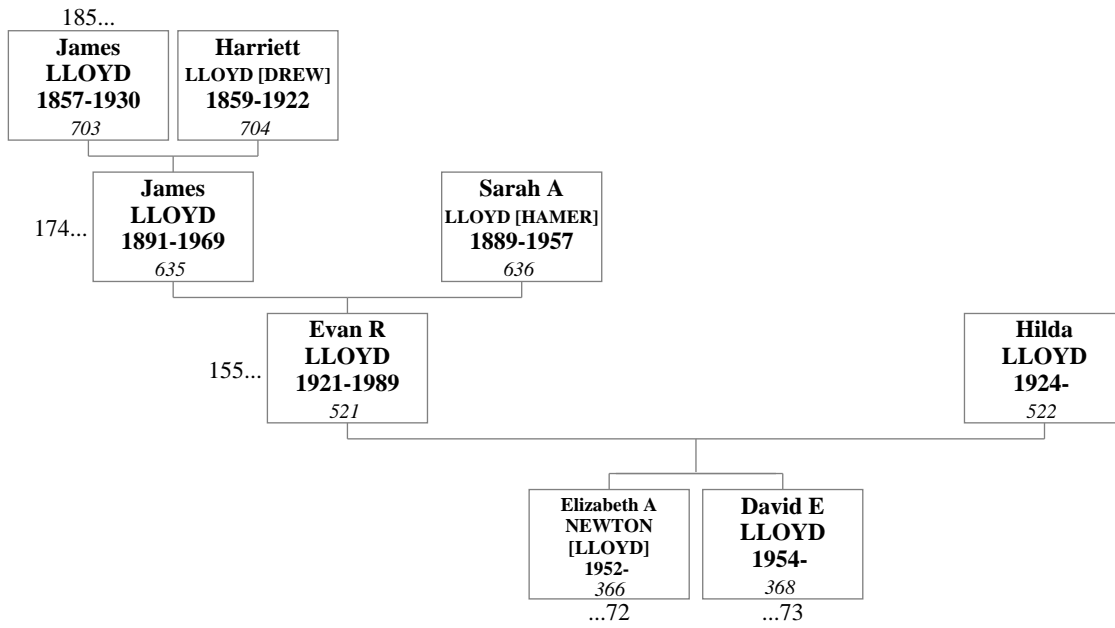

128. Henry Charles LLOYD and Enid A LLOYD [BAKER]

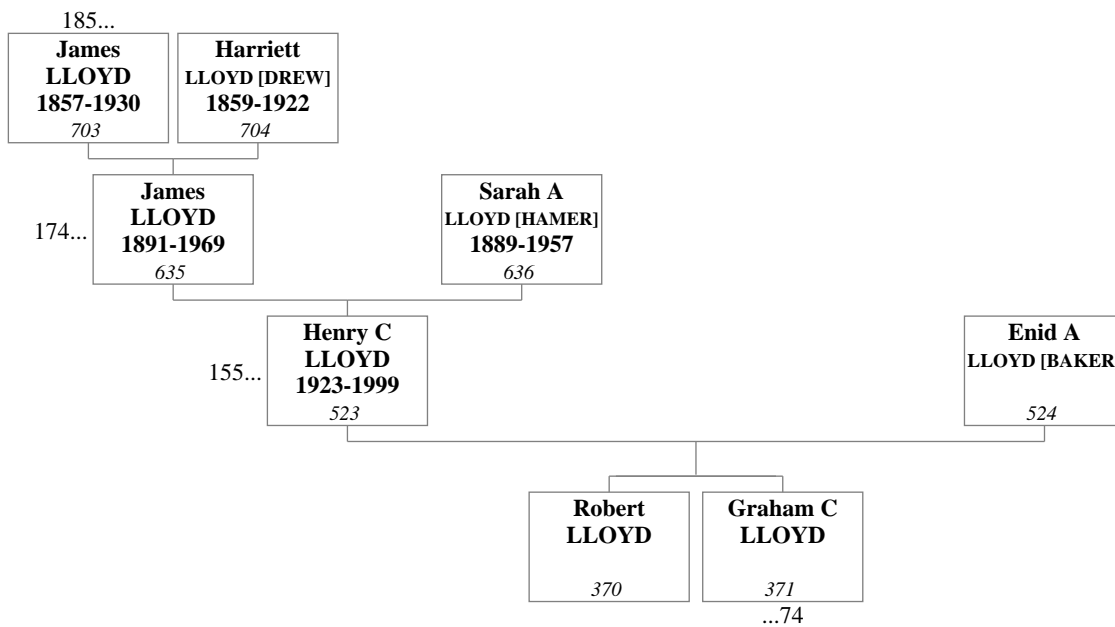

129. David POWELL and Joan POWELL [LLOYD]

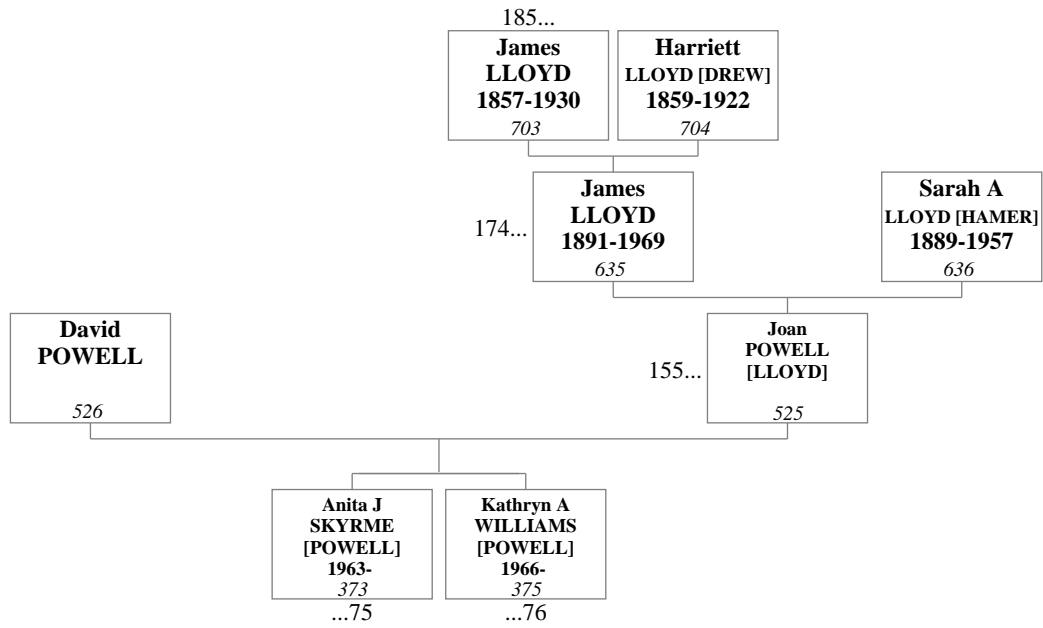

130. Hugh LLOYD and Eva Grace LLOYD [MORRIS]

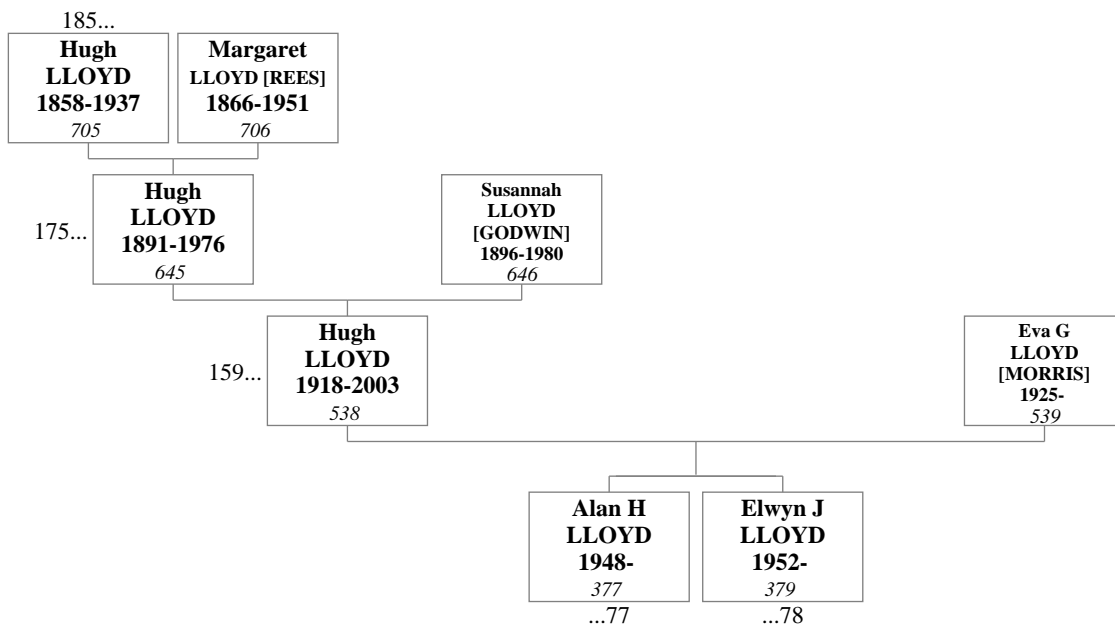

131. Victor Evan PHILLIPS and Doris PHILLIPS [LLOYD]

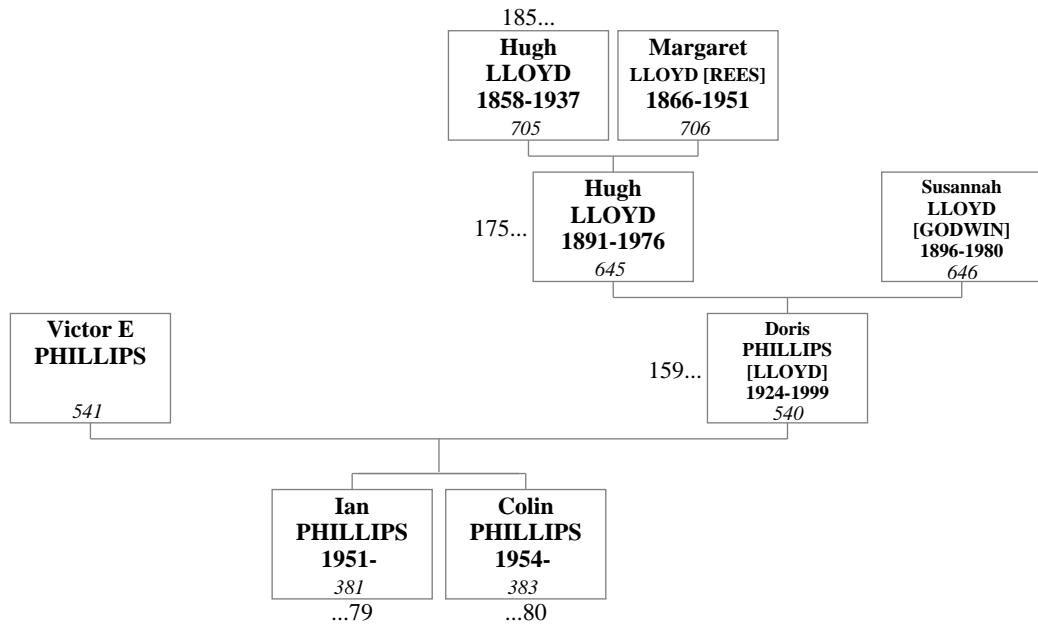

132. John LEWIS and Elizabeth Nancy LEWIS [LLOYD]

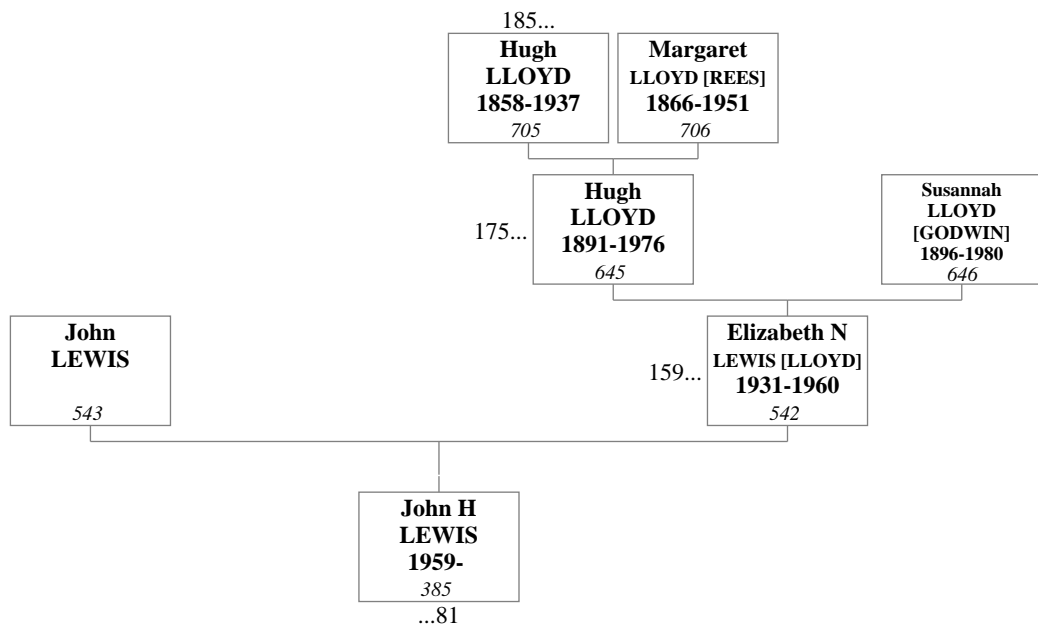

133. Edward PRICE and Margaret PRICE [LLOYD]

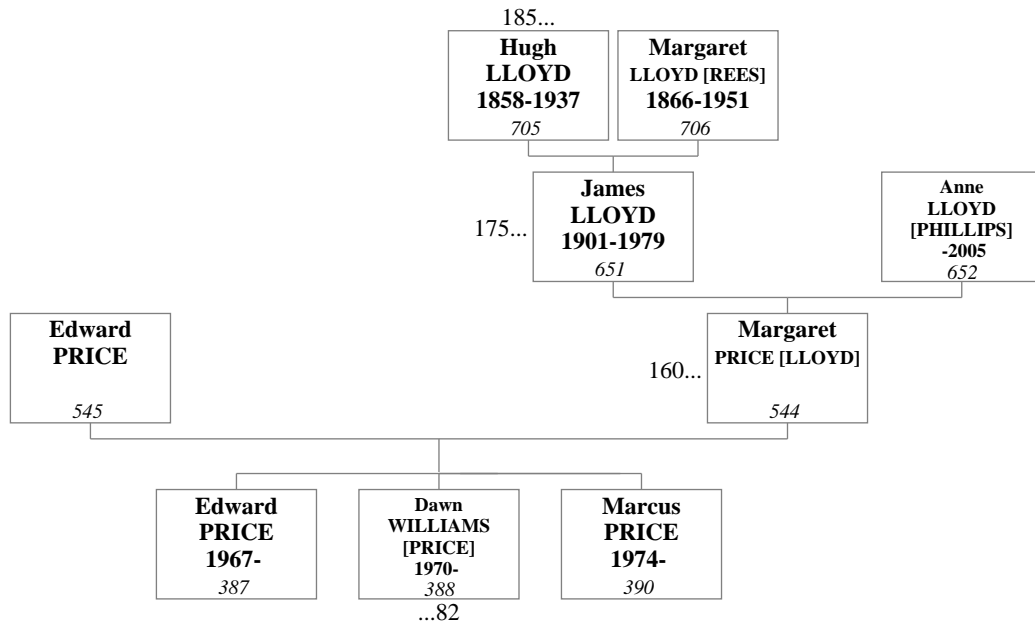

134. Edmundd Danzey DREW and Margaret DREW [LLOYD]

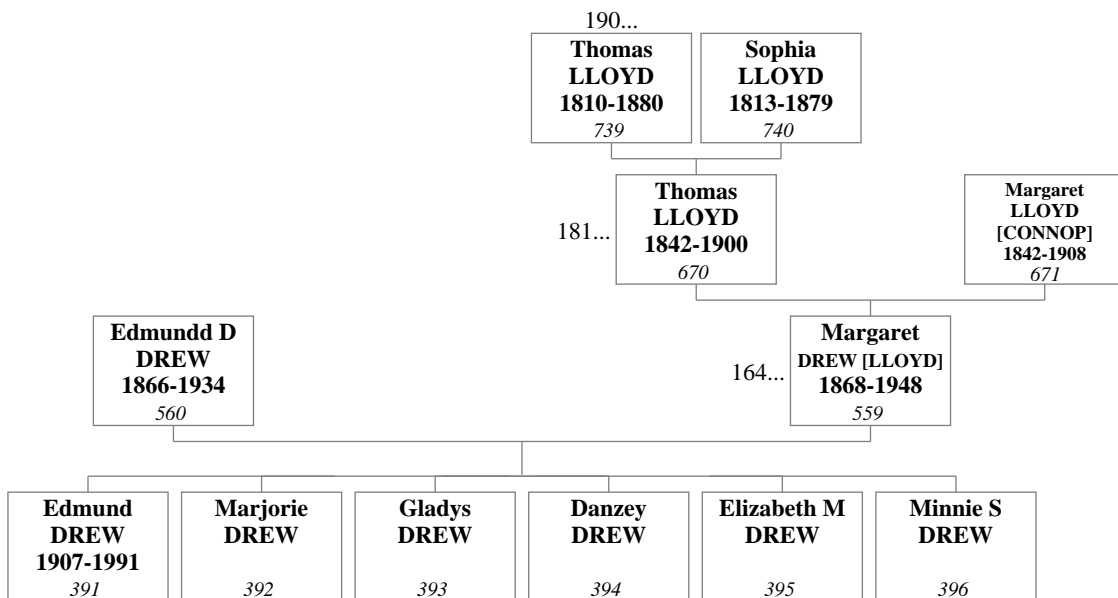

135. William WILLIAMS and Mary Ann (Polly) WILLIAMS [LLOYD]

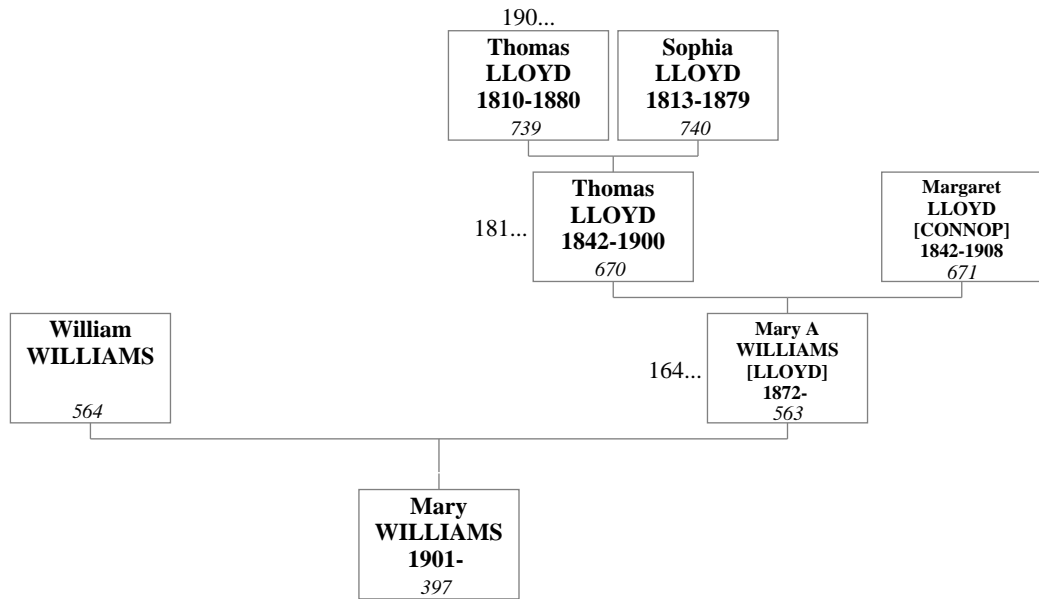

136. Richard BYWATER and Sarah Rosa BYWATER [LLOYD]

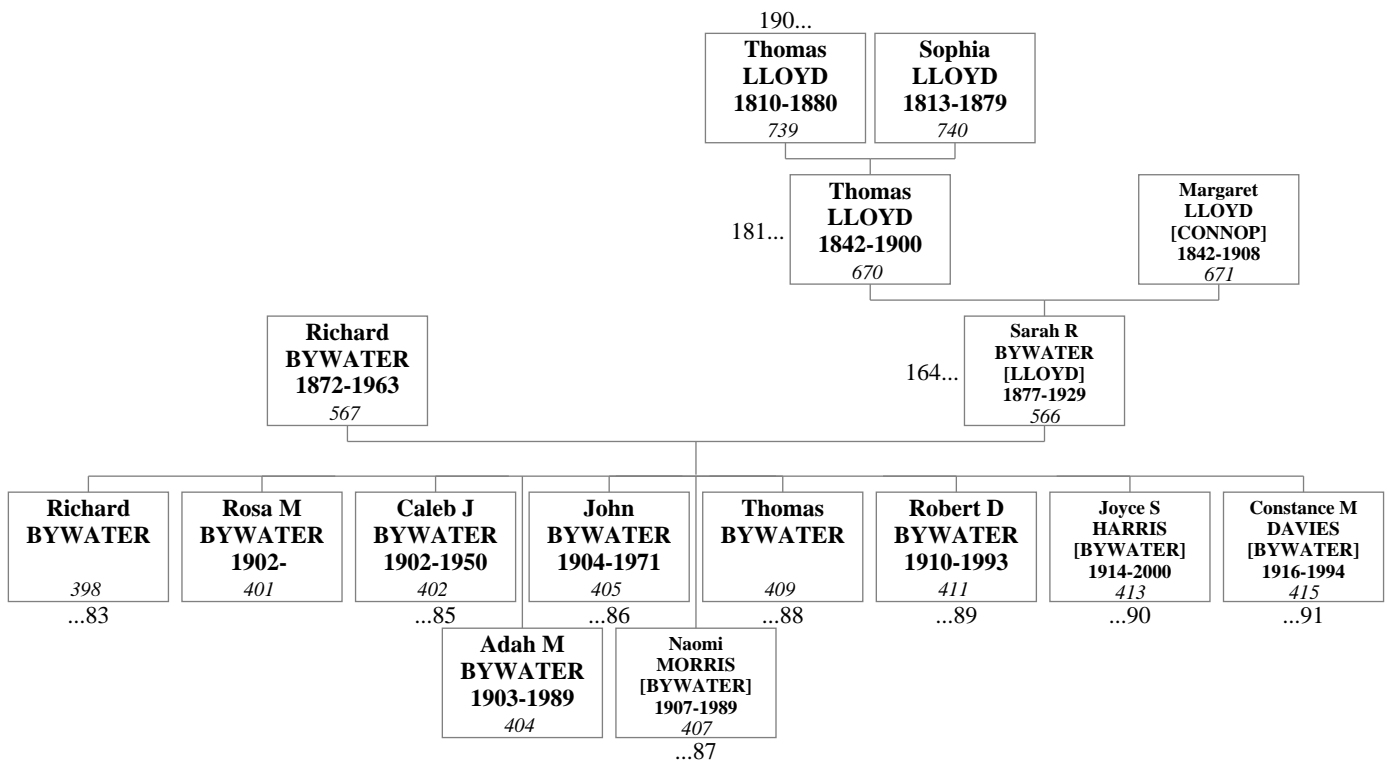

137. William Owen ROBERTS and Ann Sophia ROBERTS [LLOYD]

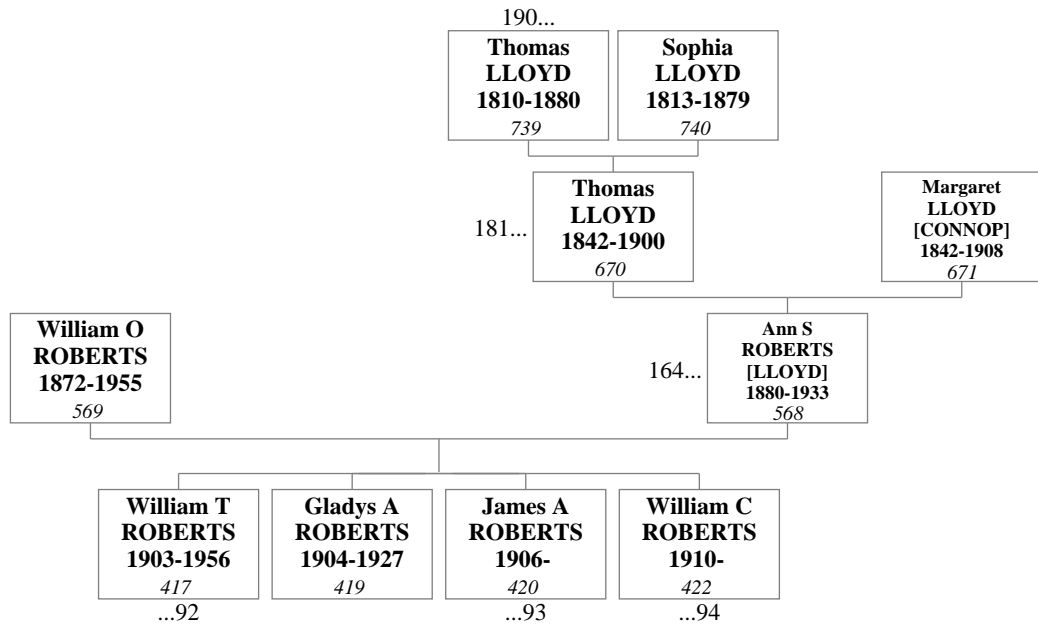

138. Hugh LLOYD and Florence LLOYD [HARLEY]

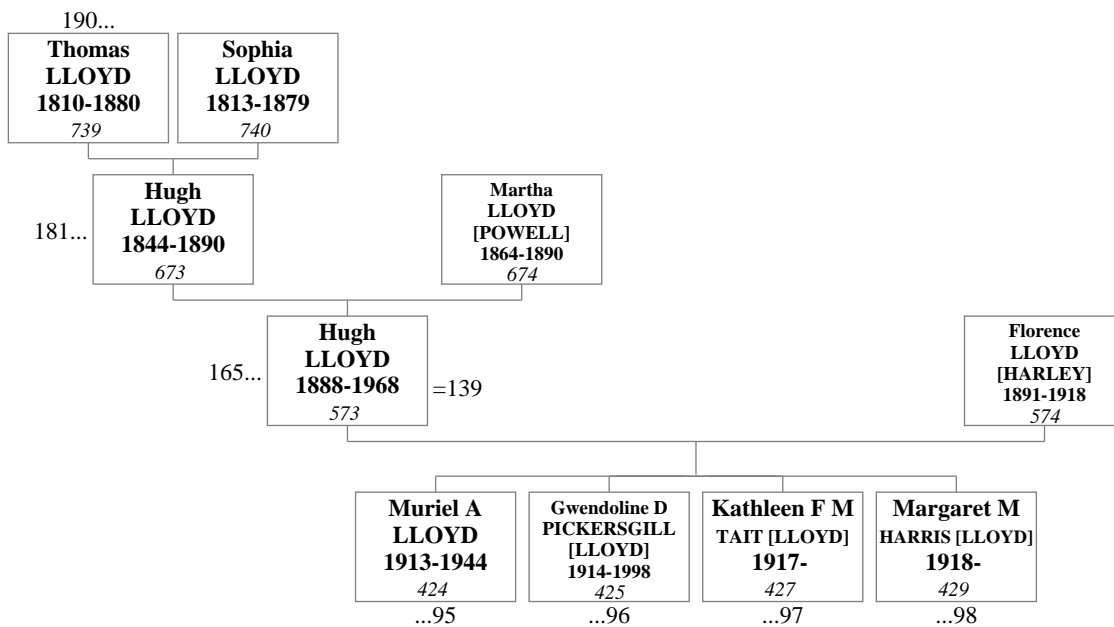

139. Hugh LLOYD and Emily Elizabeth LLOYD [WILLOUGHBY]

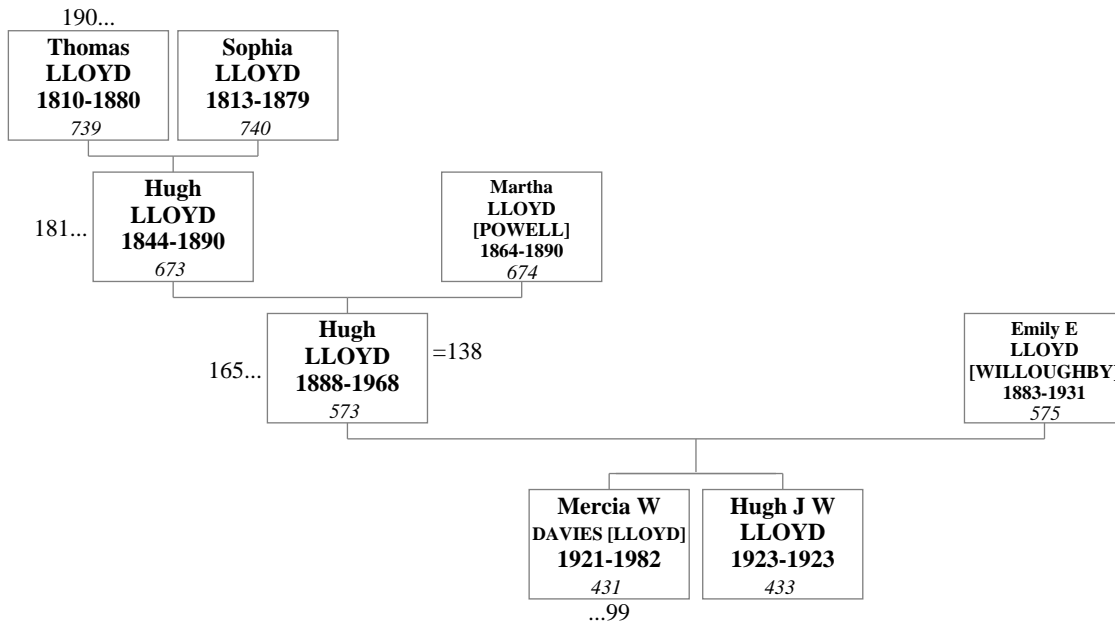

140. Mr. Unknown and Annie Sophia (aka Nancy) LLOYD

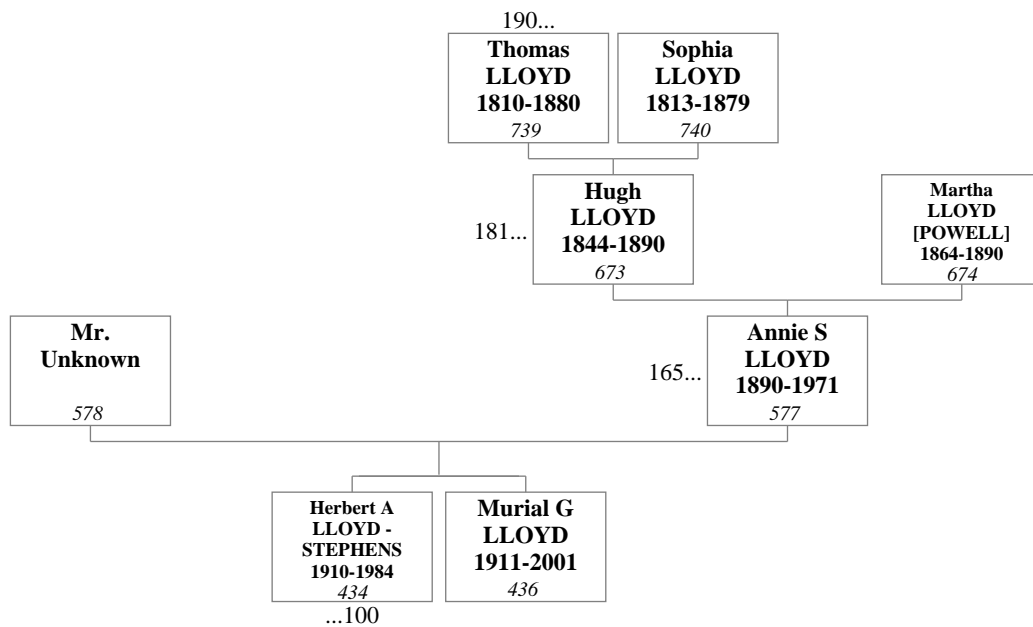

141. Ernest Edward EVES and Sophia Matilda (Tillie) EVES [LLOYD]

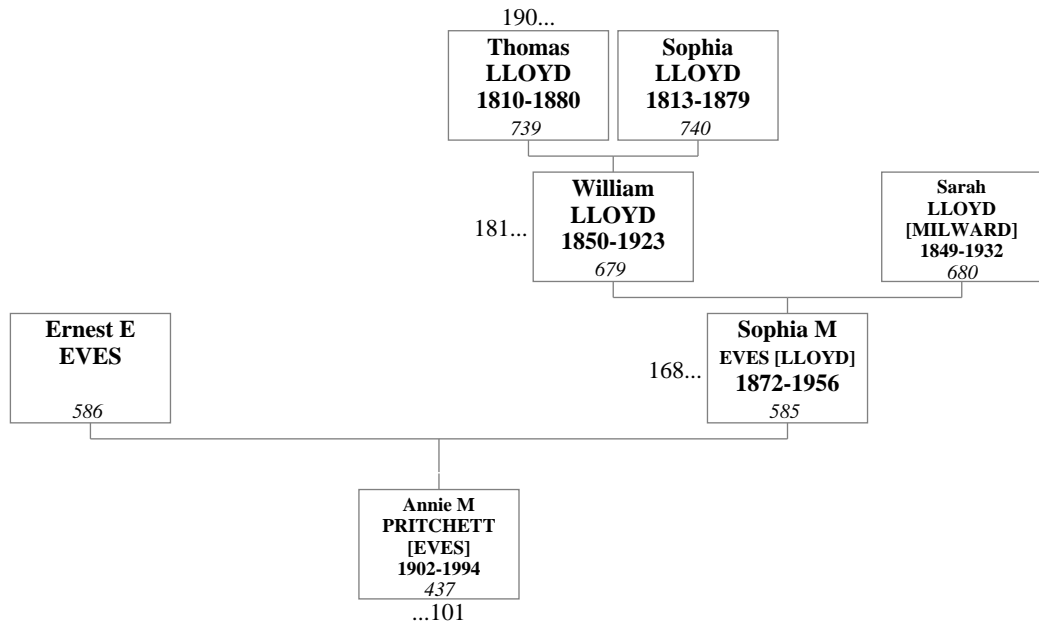

142. Thomas LANE and Elizabeth Anne (Annie) LANE [LLOYD]

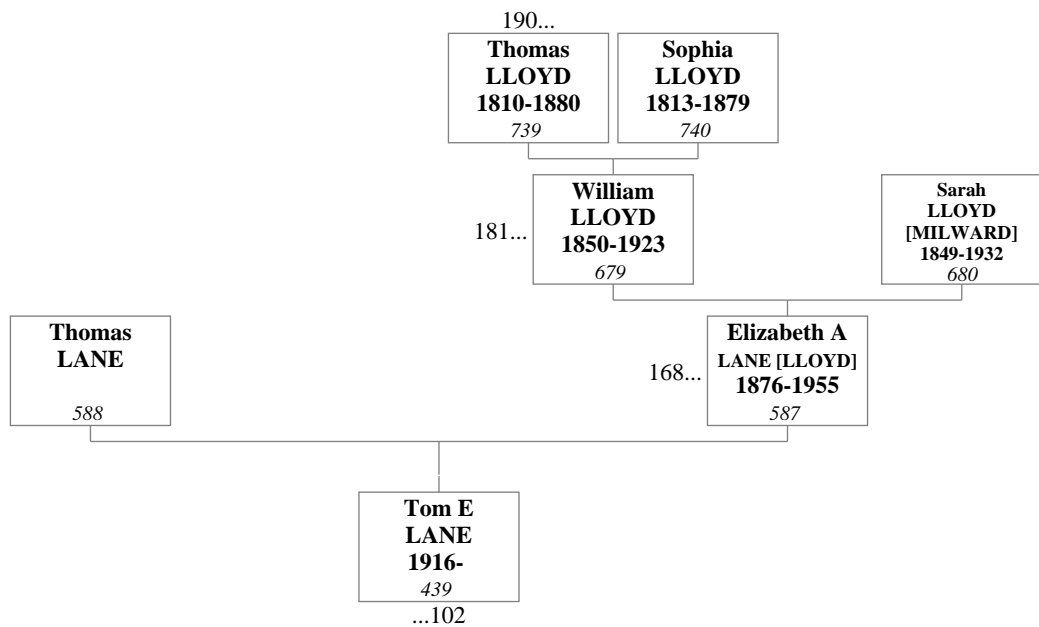

143. Hugh LLOYD and Laura LLOYD [KINGS]

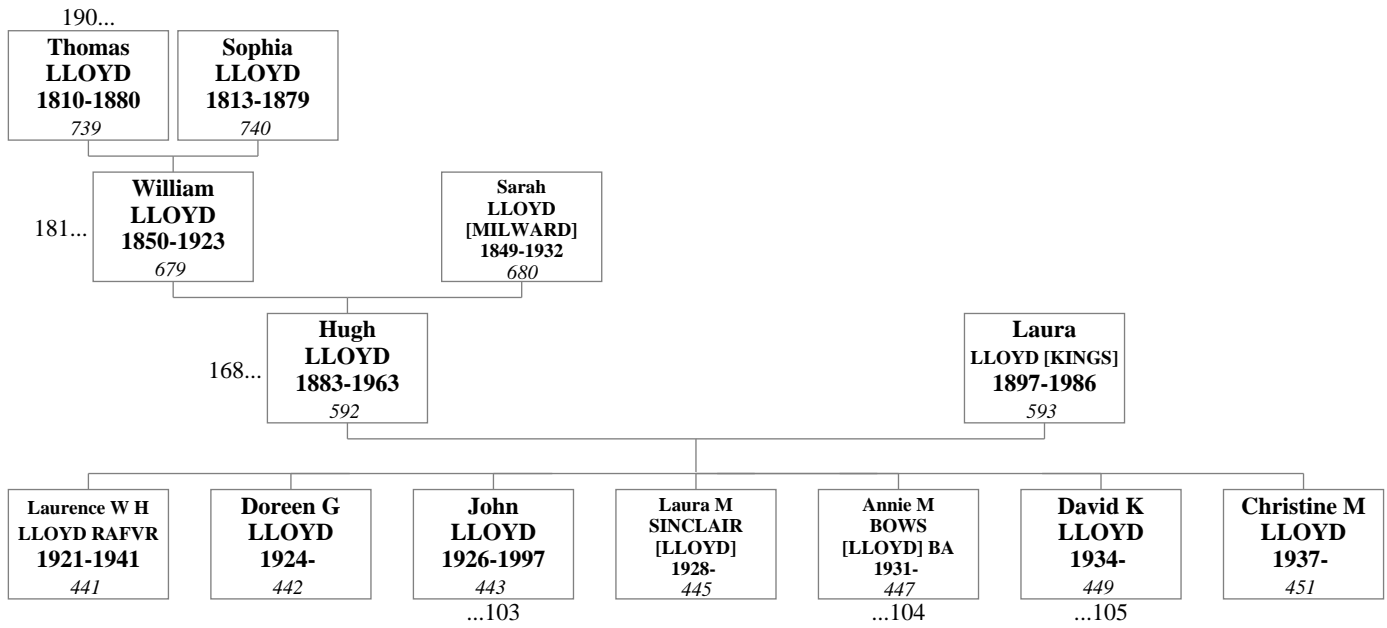

144. Thomas John LLOYD and Catherine LLOYD [JONES]

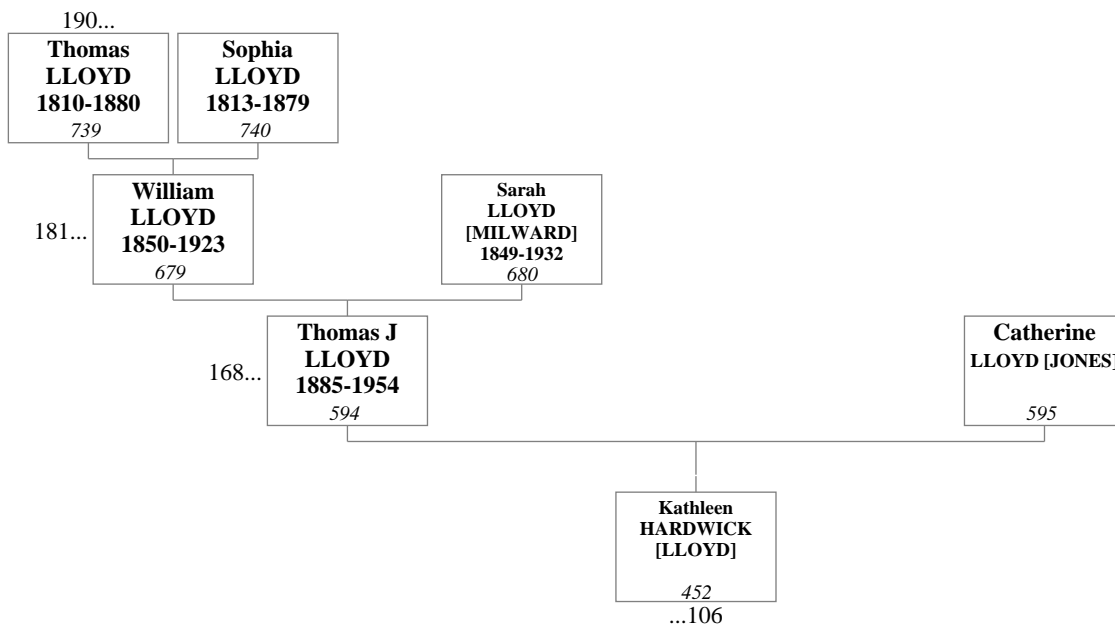

145. Evan Sidney LLOYD and Mabel LLOYD [KINGS]

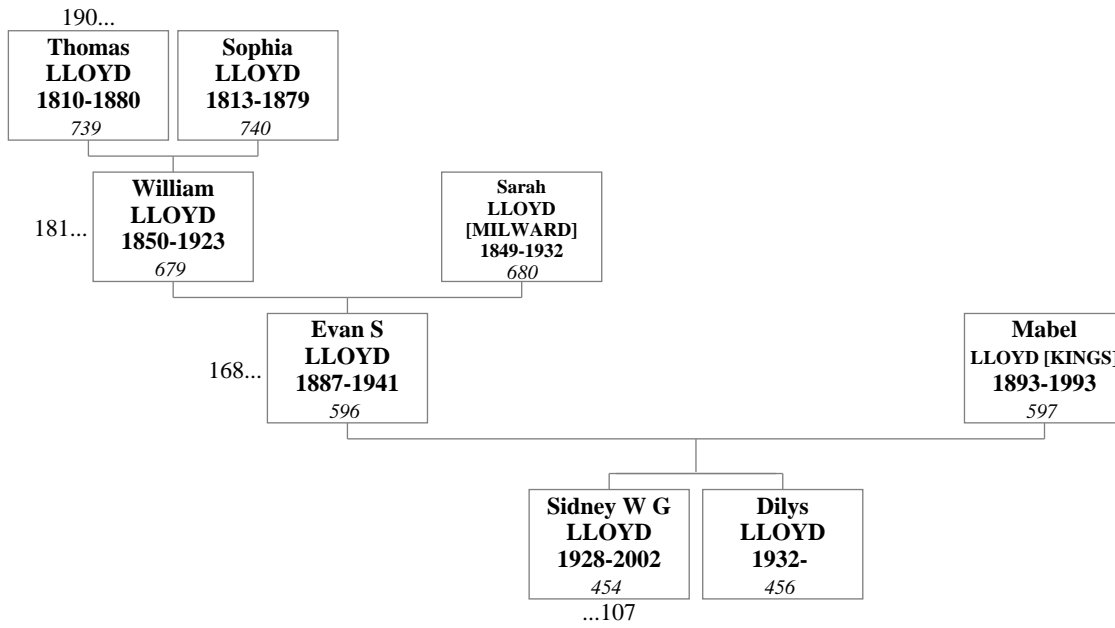

146. Arthur STRATTON and Sarah Janet STRATTON [LLOYD]

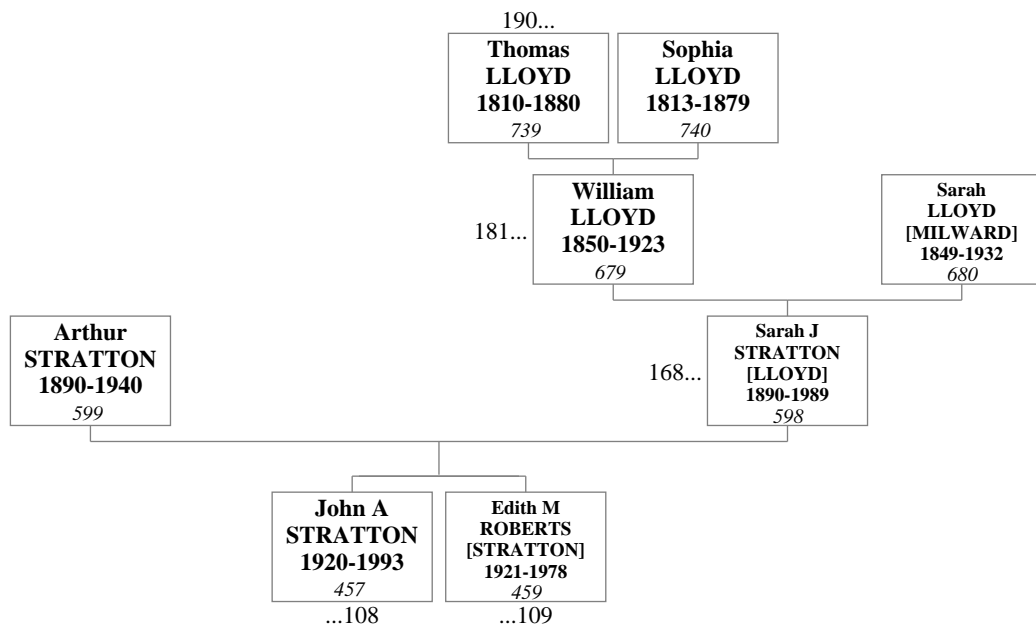

147. David PUGH and Eva PUGH [GRIFFITHS]

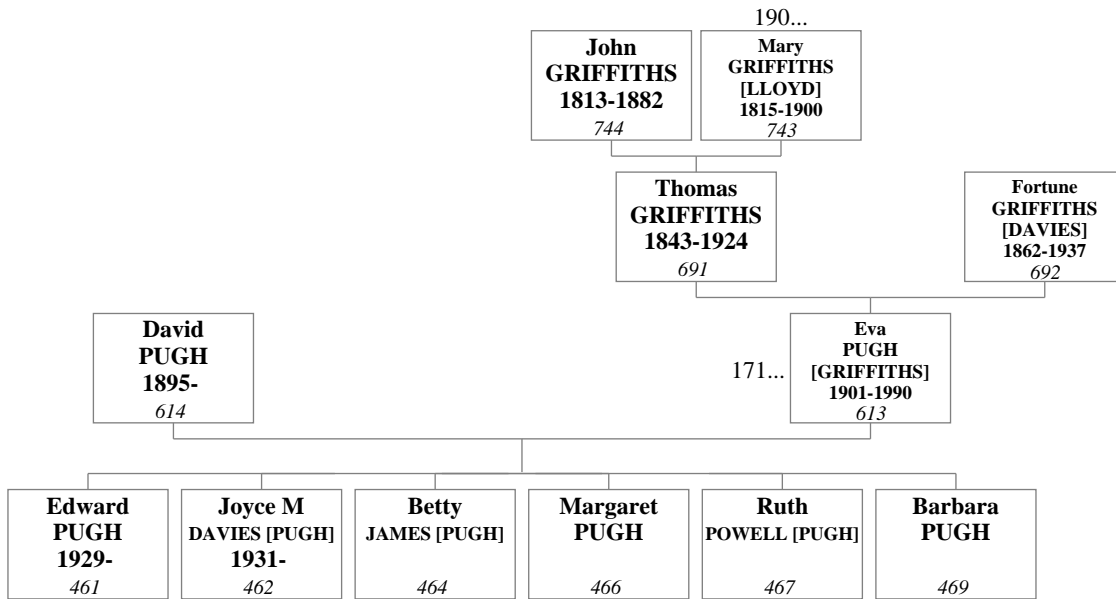

148. Thomas Clement J GRIFFITHS and Blanche PEVERILL

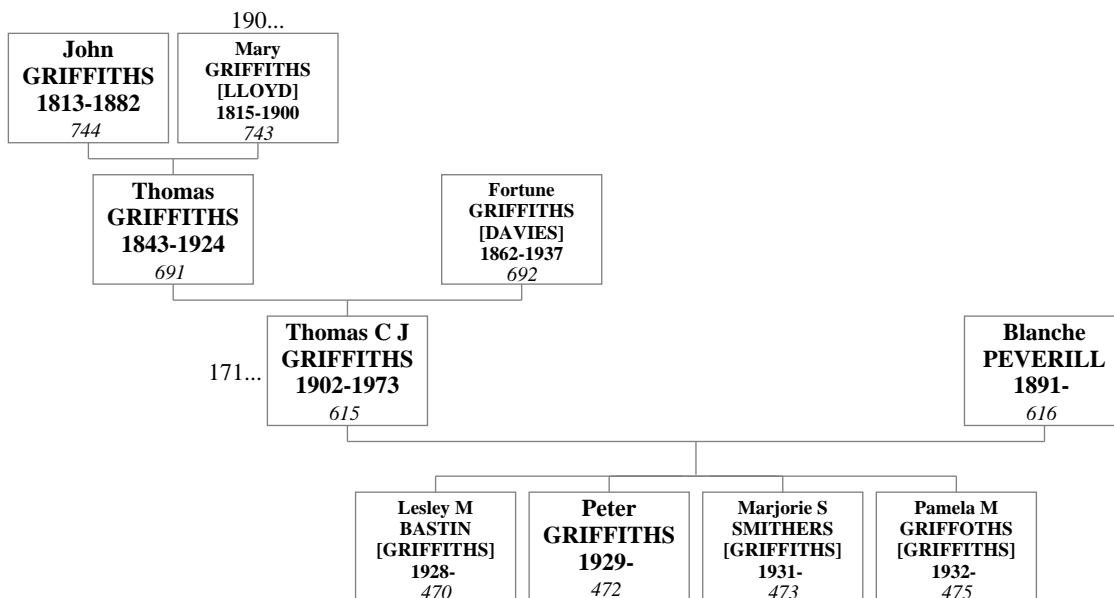

149. Arthur GRIFFITHS and Maud GRIFFITHS [EVANS]

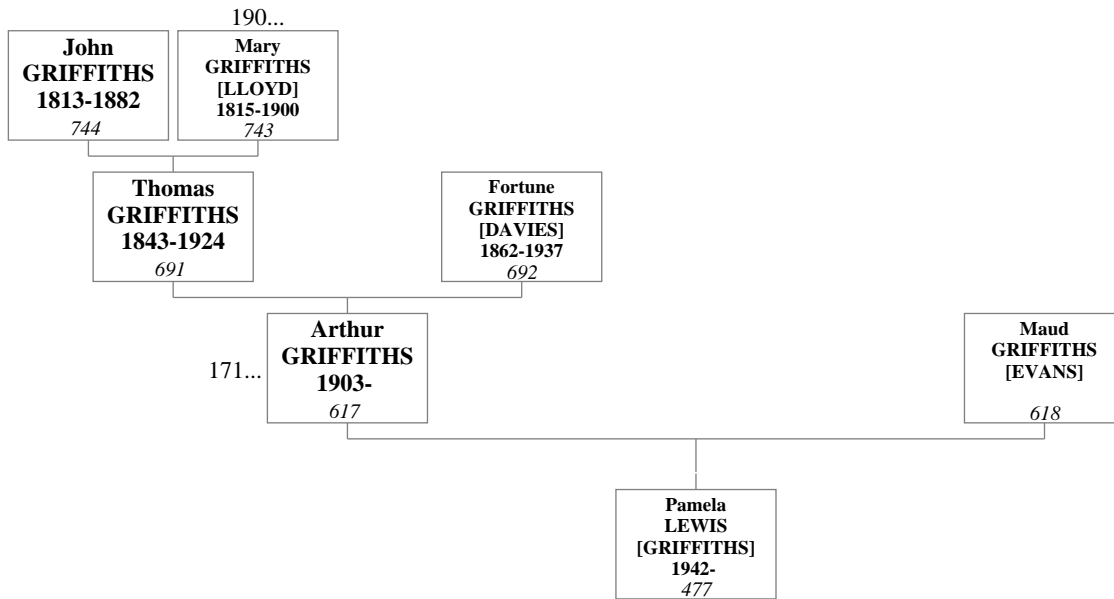

150. Ivor WHITTALL and Gwendoline Gertrude WHITTALL [LLOYD]

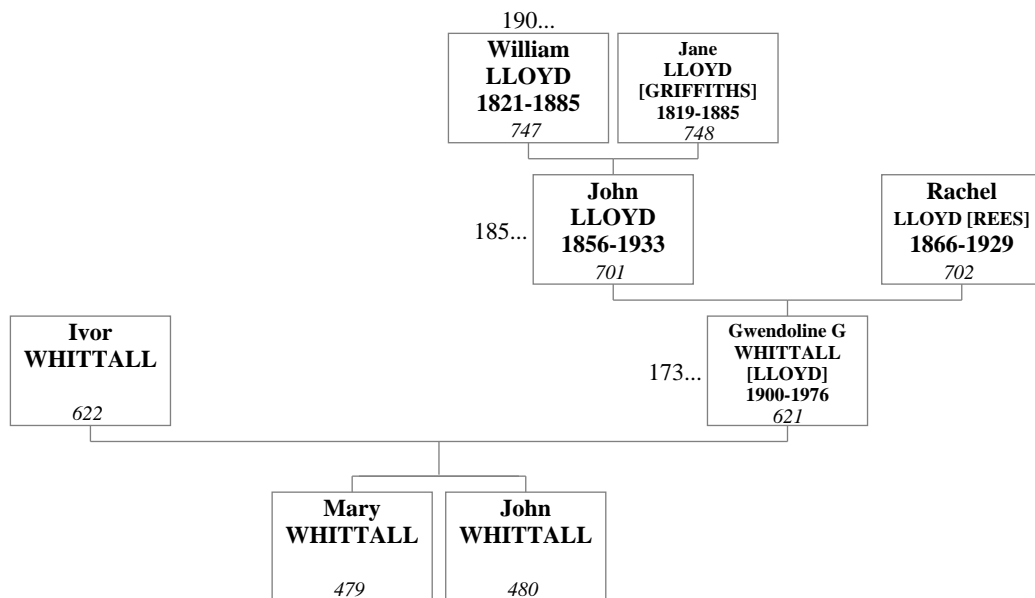

151. Thomas John POWELL and Jane Sophia POWELL [LLOYD]

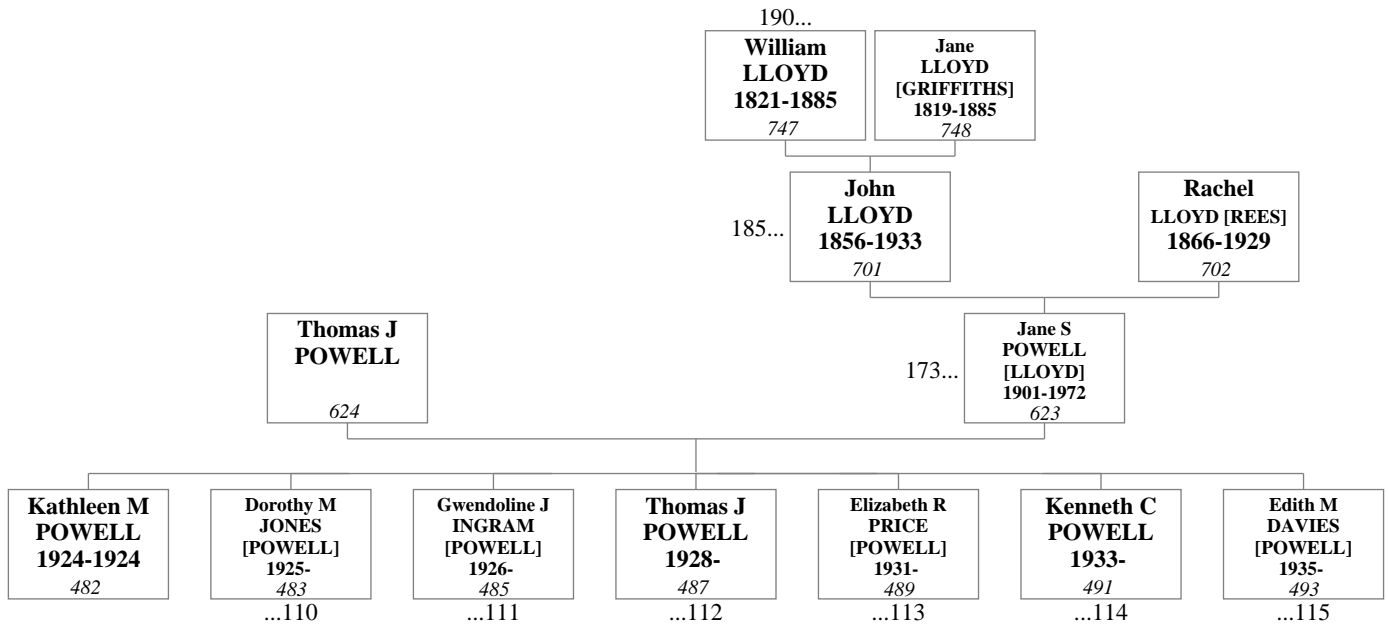

152. William Baden POWELL and Edith Mary POWELL [LLOYD]

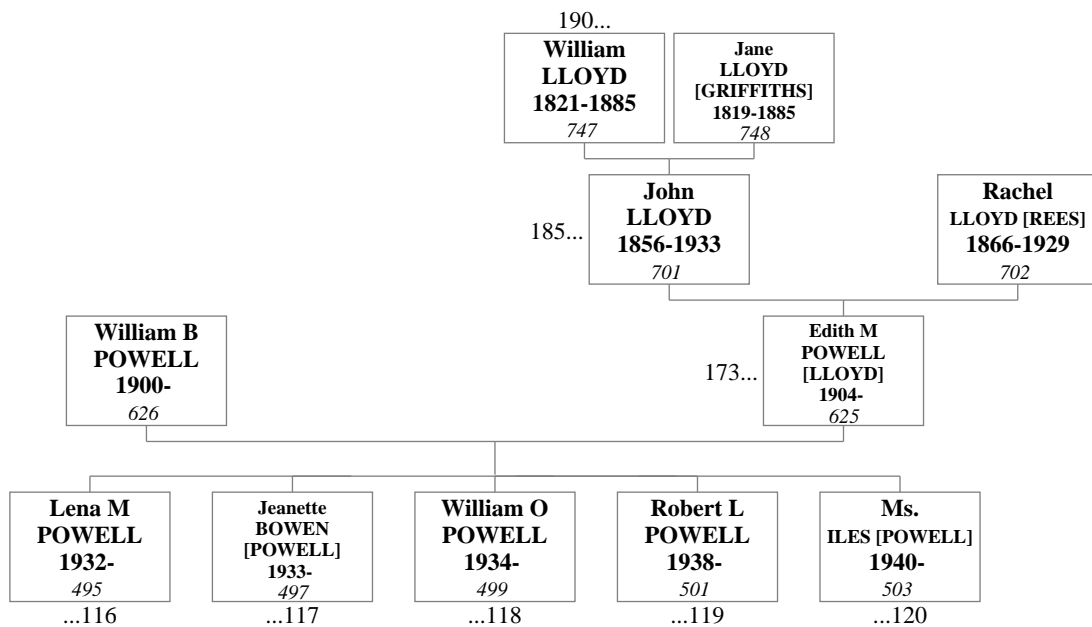

153. Henry (Harold) JAMES and Sarah Jane (Janey) JAMES [LLOYD]

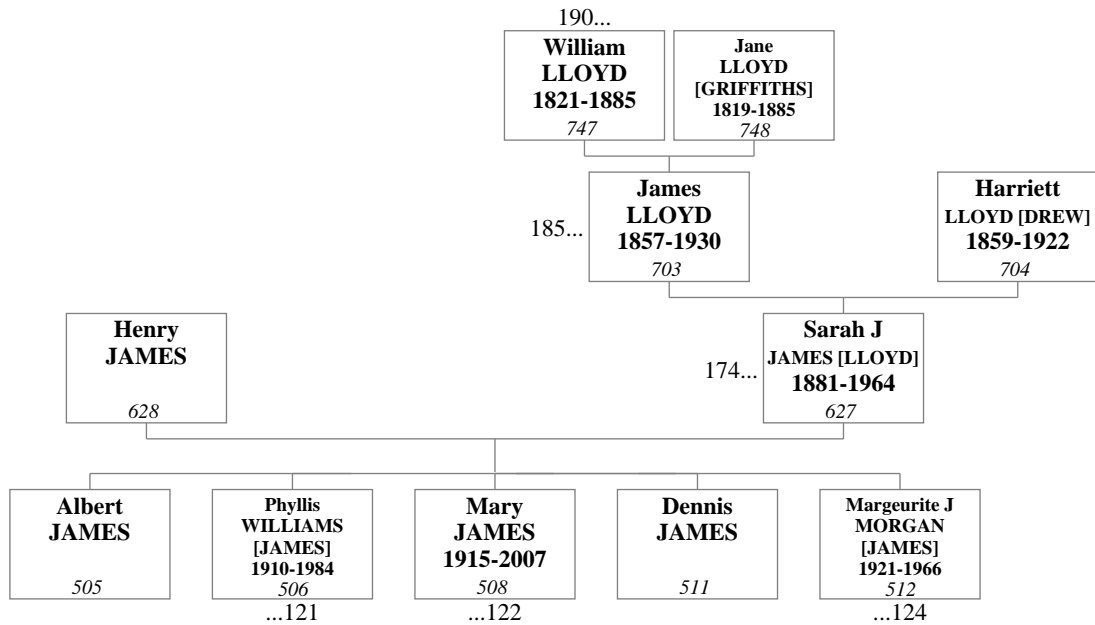

154. Thomas LLOYD and Margaret Jane LLOYD [PRITCHARD]

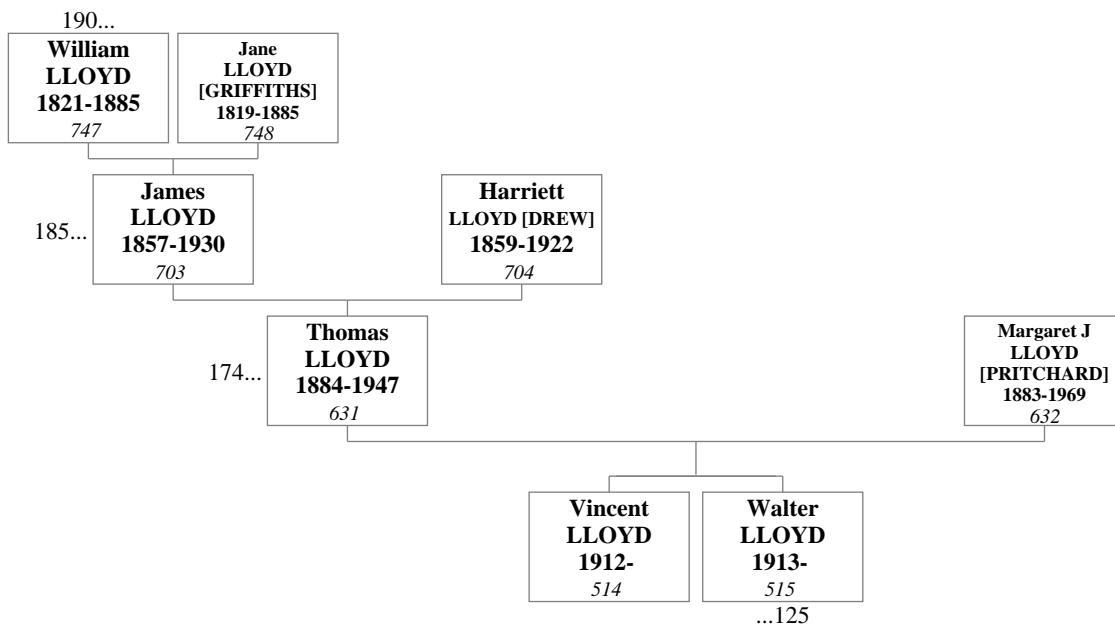

155. James LLOYD and Sarah Ann LLOYD [HAMER]

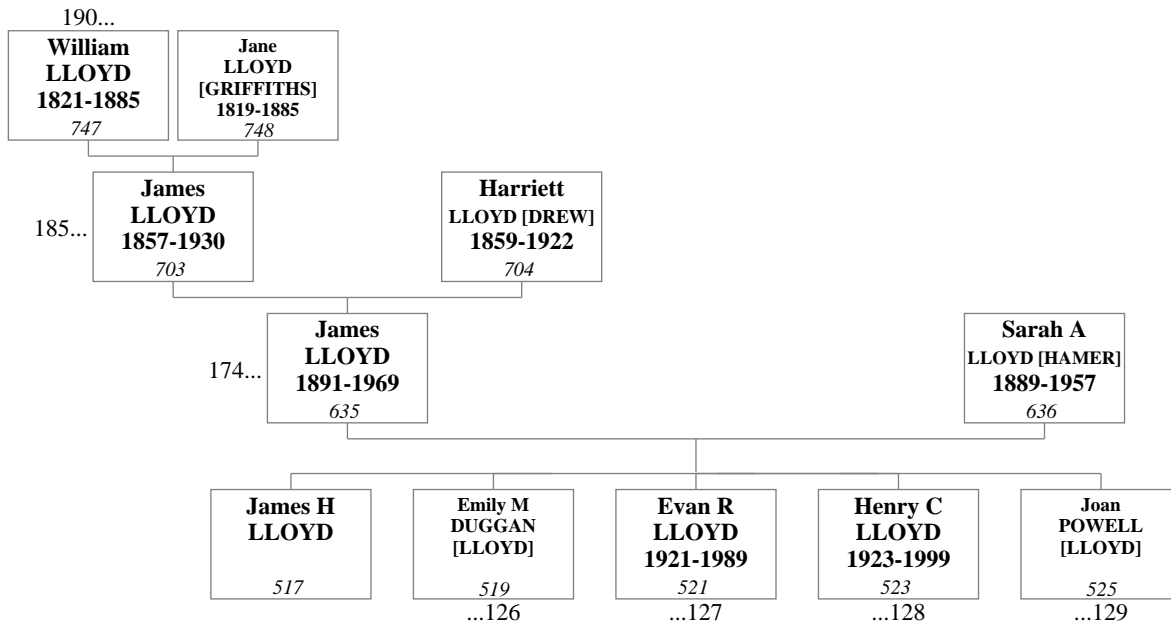

156. Charles LLOYD and Lily May (aka Doris) LLOYD [EVANS]

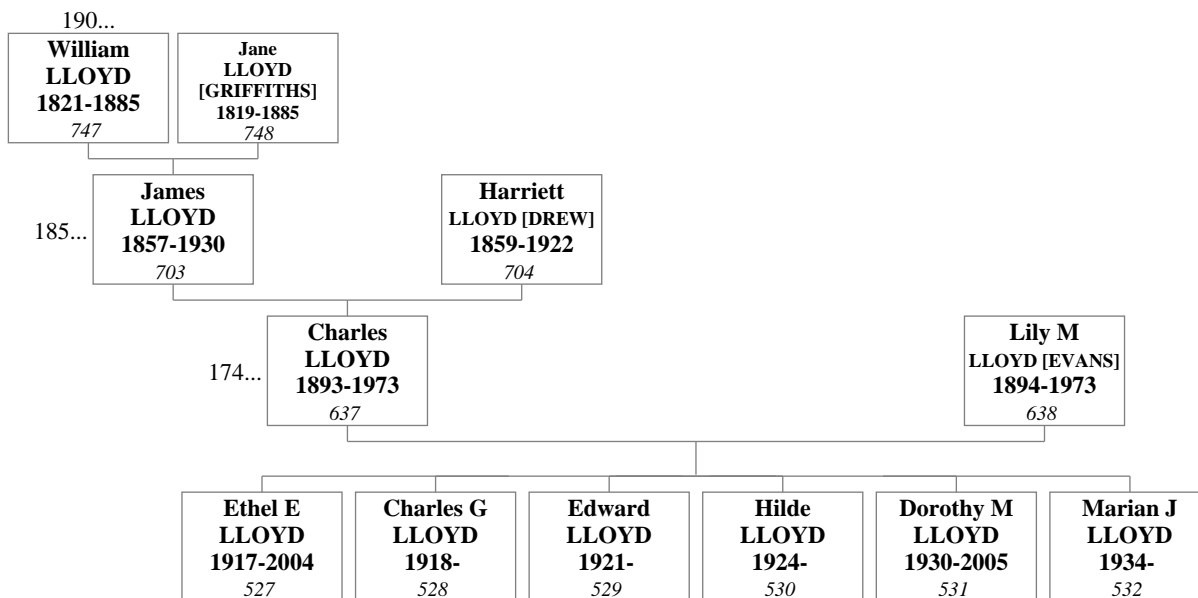

157. Hugh LLOYD and Frances LLOYD [EDITH]

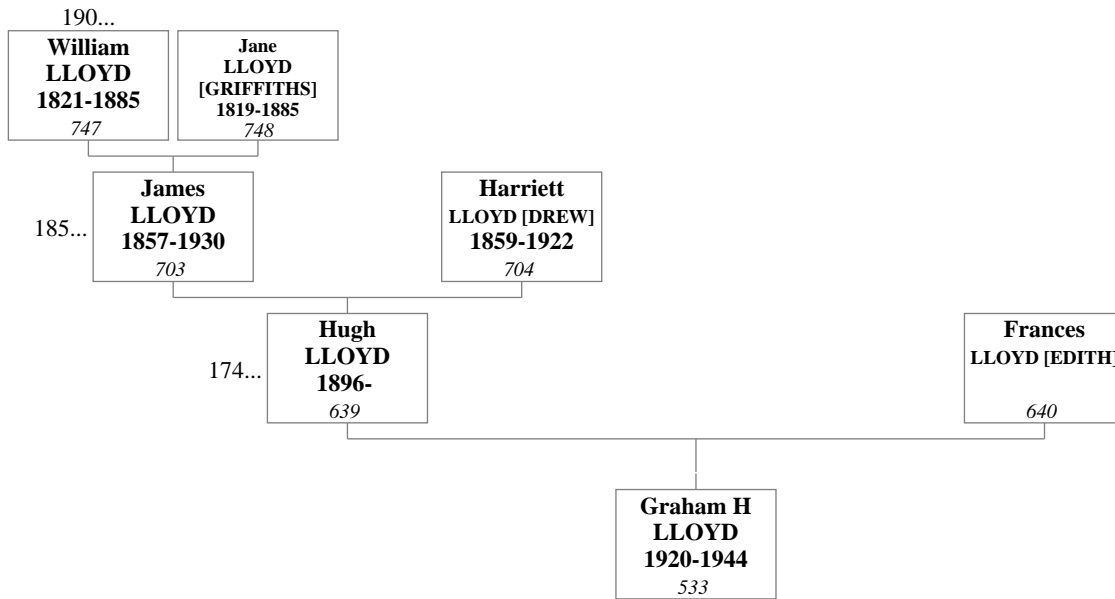

158. Danzey Evan LLOYD and Gertrude LLOYD [JONES]

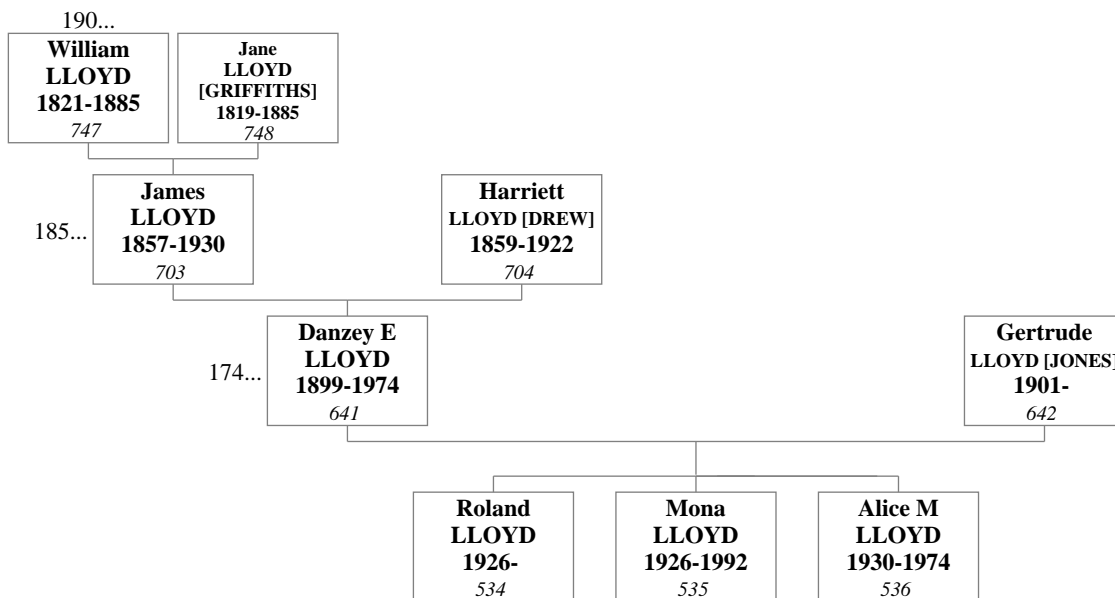

159. Hugh LLOYD and Susannah LLOYD [GODWIN]

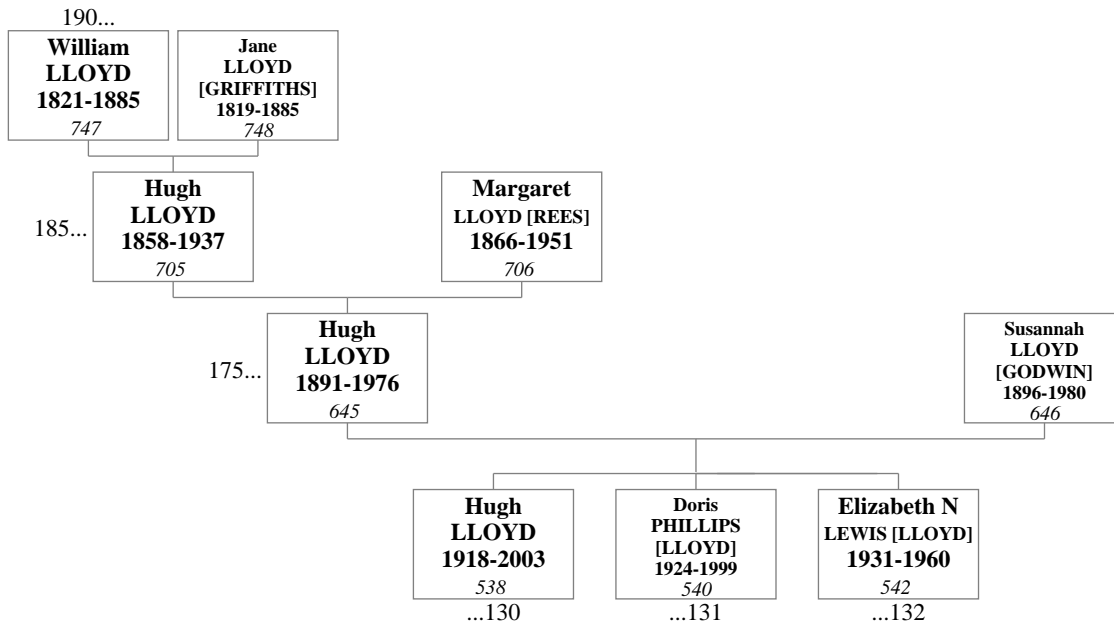

160. James LLOYD and Anne LLOYD [PHILLIPS]

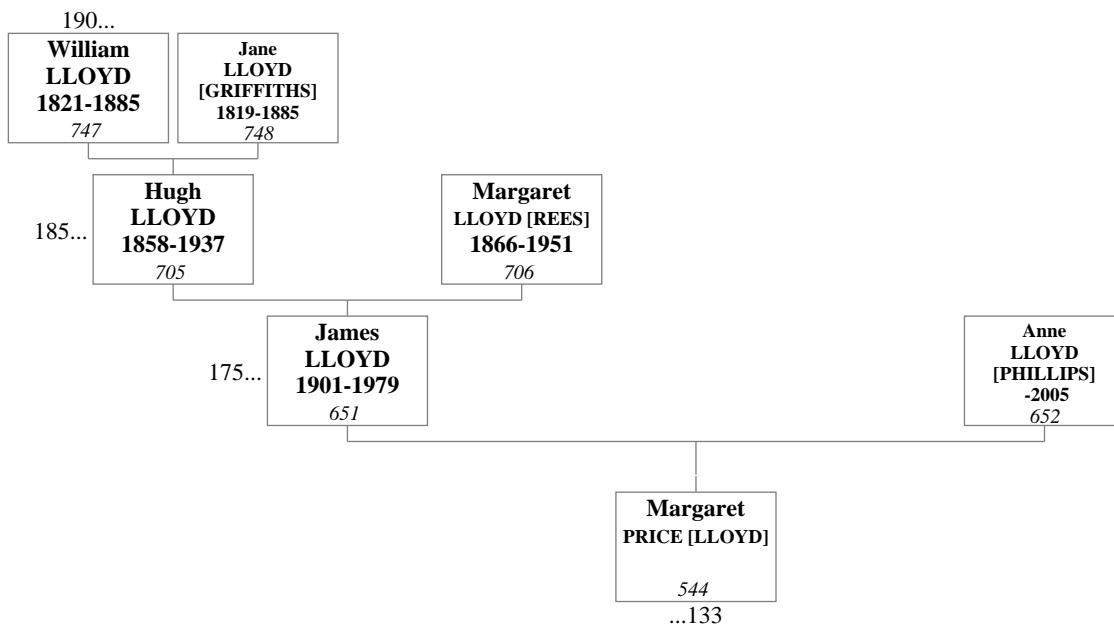

161. Thomas Hugh LLOYD and Eva May LLOYD [CLARKE]

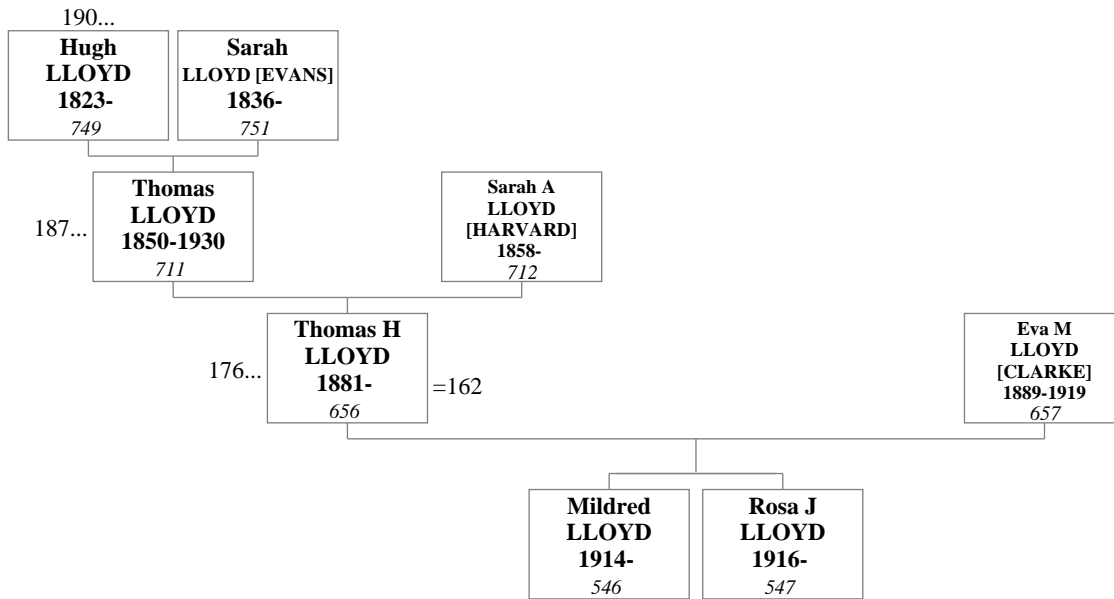

162. Thomas Hugh LLOYD and Beatrice Eva LLOYD [LEWIS]

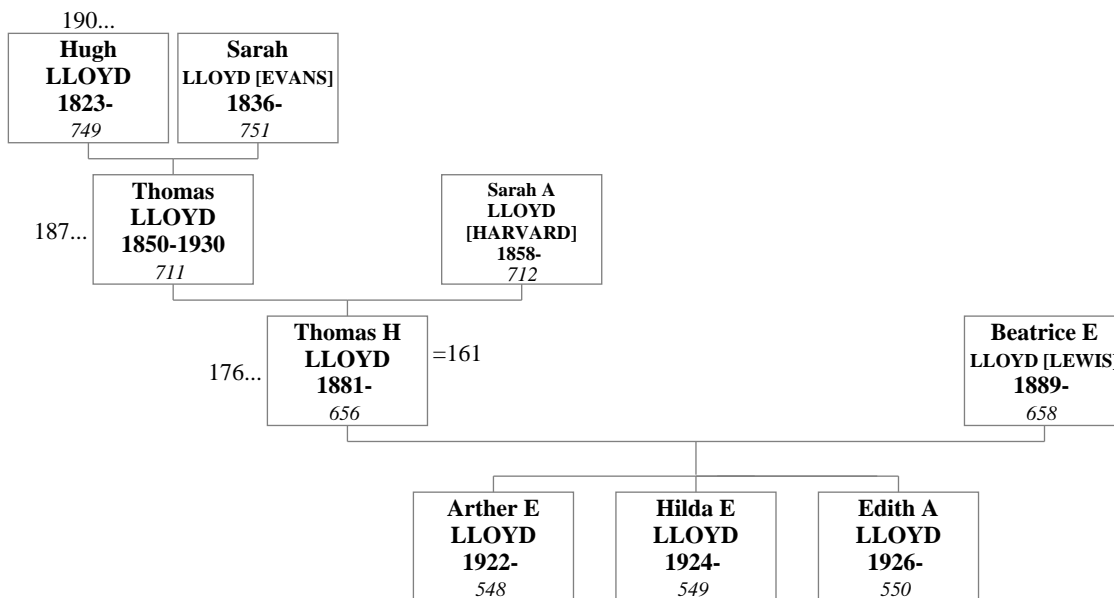

163. Samuel MEREDITH and Ann MEREDITH [LLOYD]

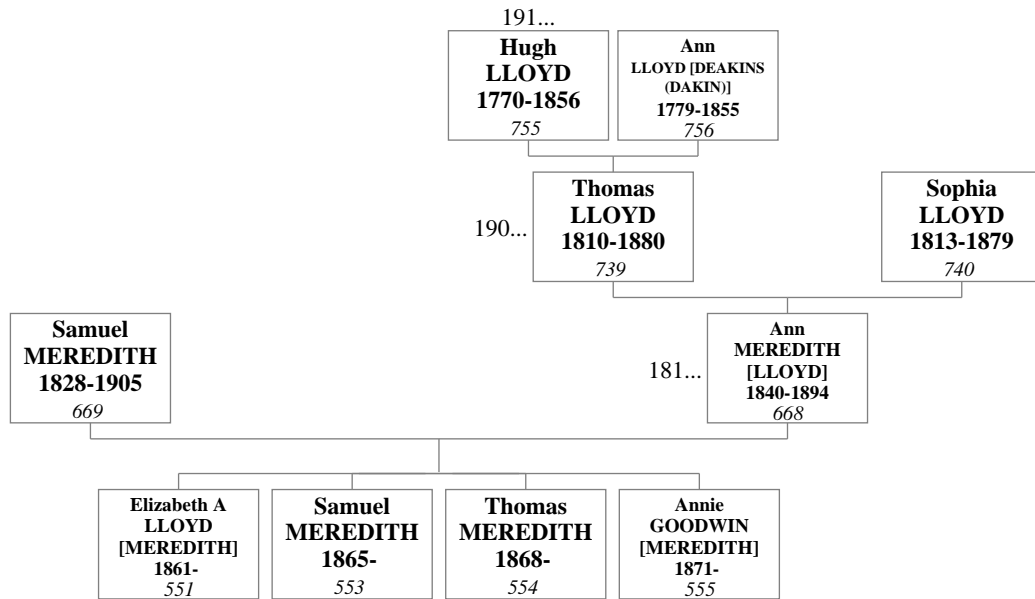

164. Thomas LLOYD and Margaret LLOYD [CONNOP]

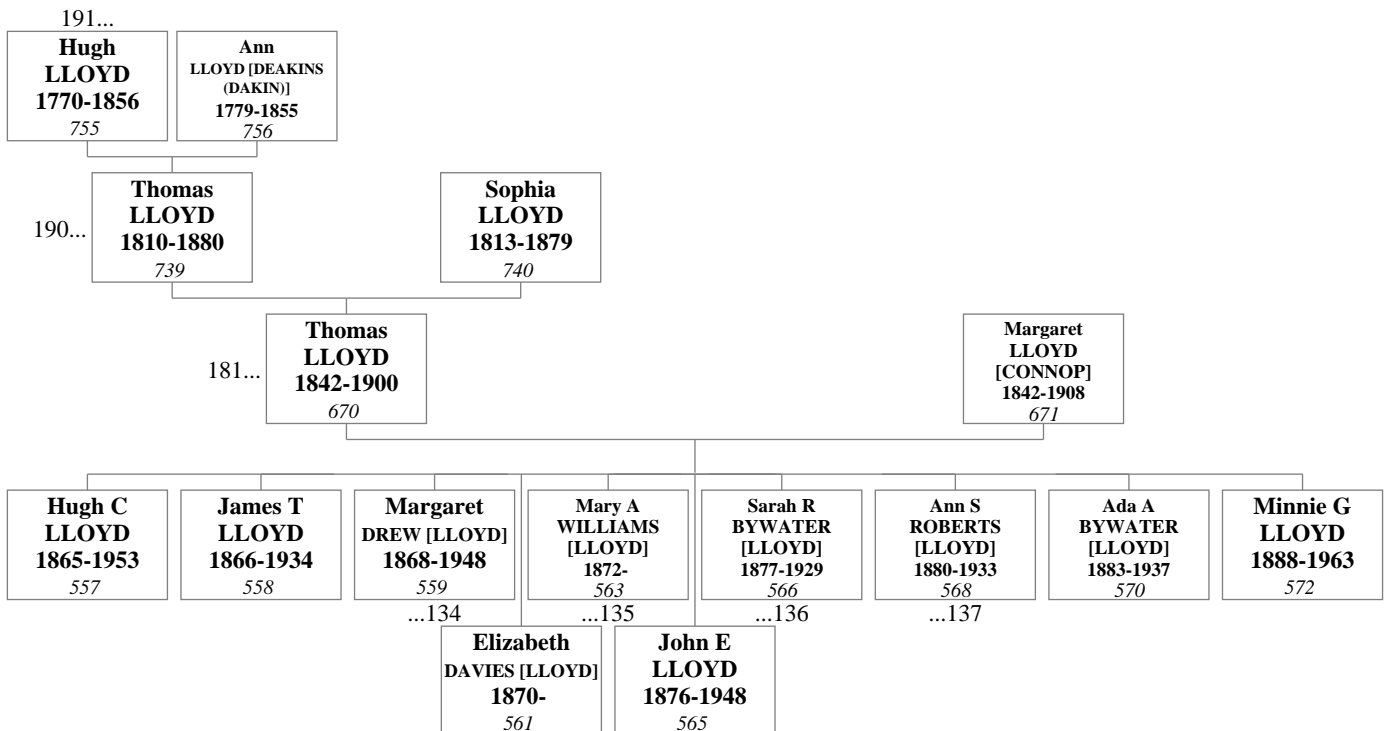

165. Hugh LLOYD and Martha LLOYD [POWELL]

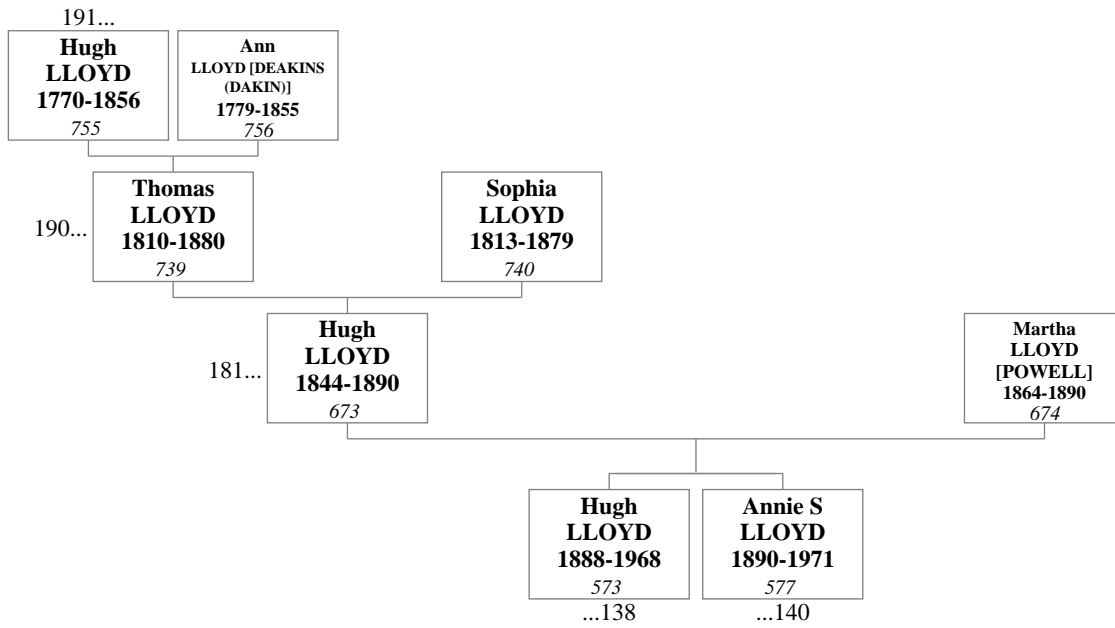

166. John LLOYD and Mary Ann LLOYD [DAVIES]

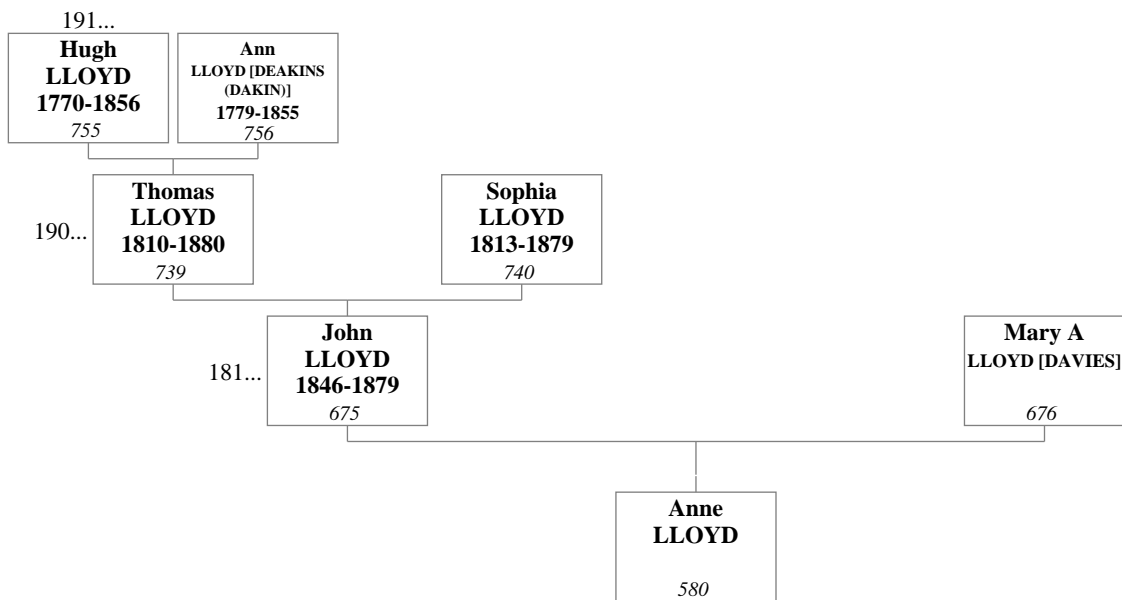

167. James JAMES and Elizabeth (Bessie) JAMES [LLOYD]

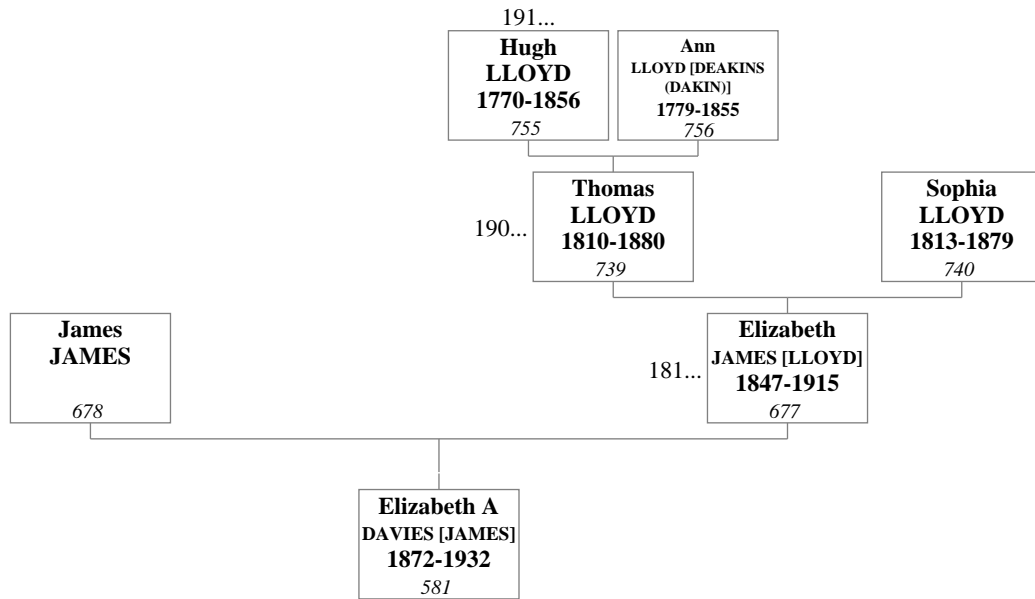

168. William LLOYD and Sarah LLOYD [MILWARD]

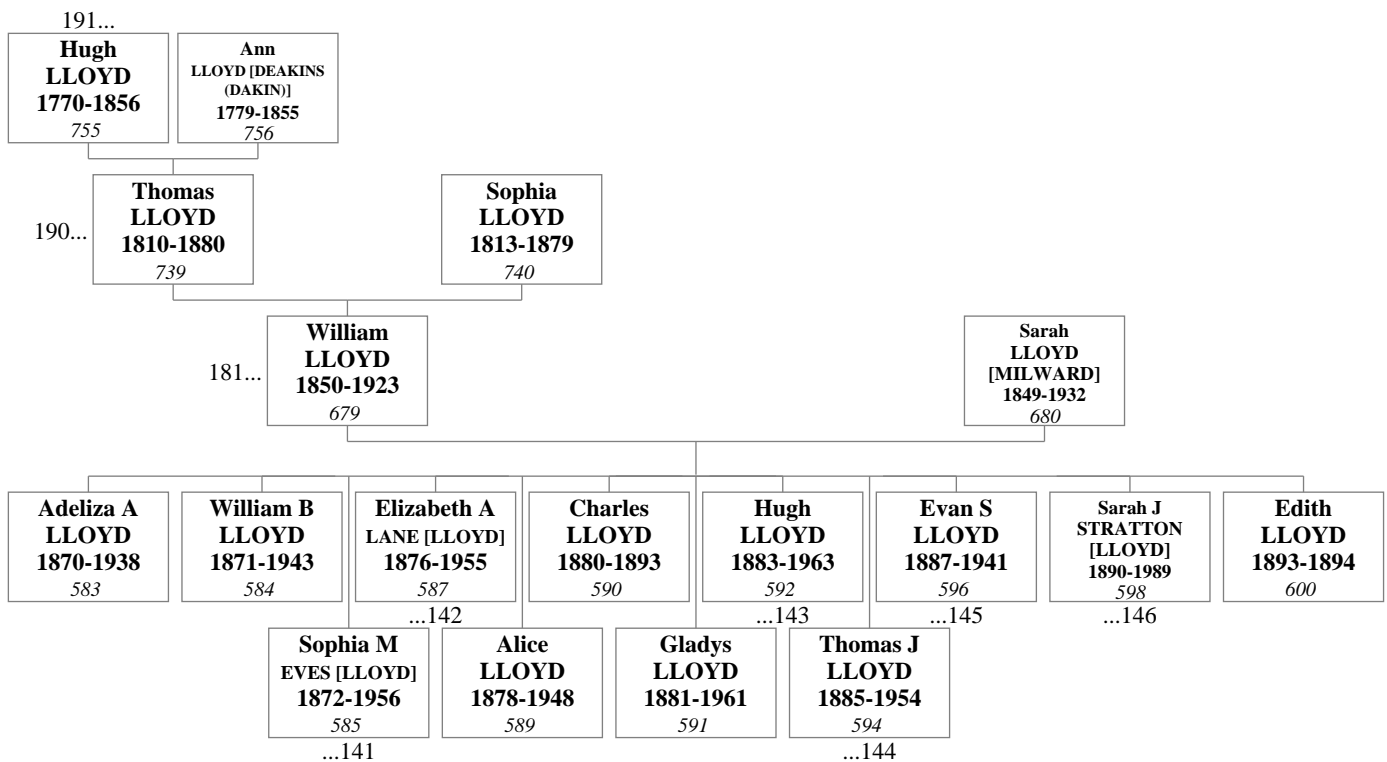

169. Evan LLOYD and Clara LLOYD [HILL]

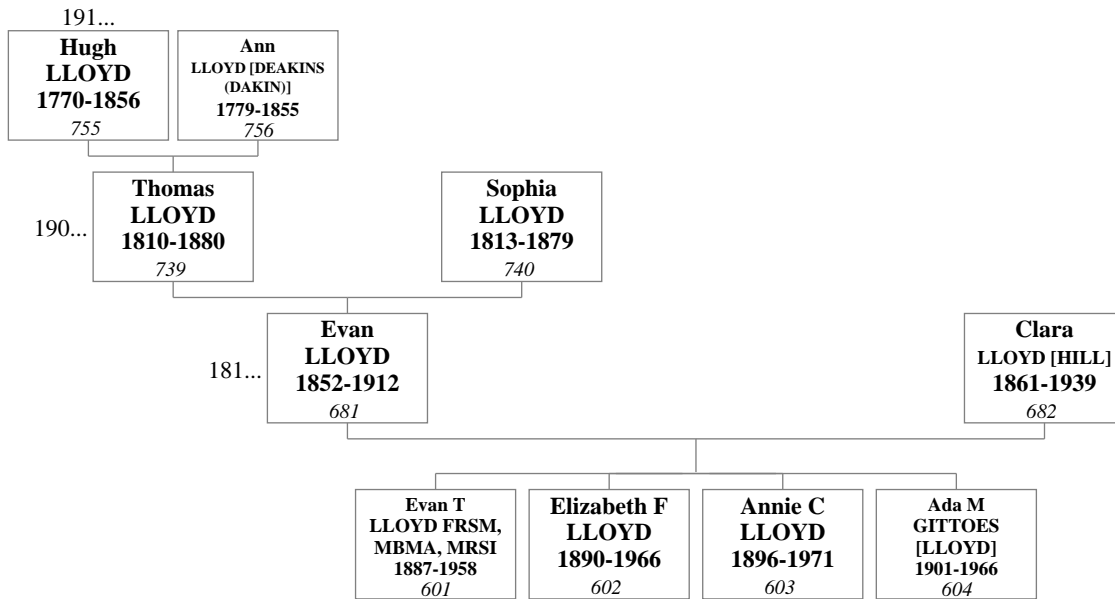

170. William MORGAN and Sarah Sophia MORGAN [LLOYD]

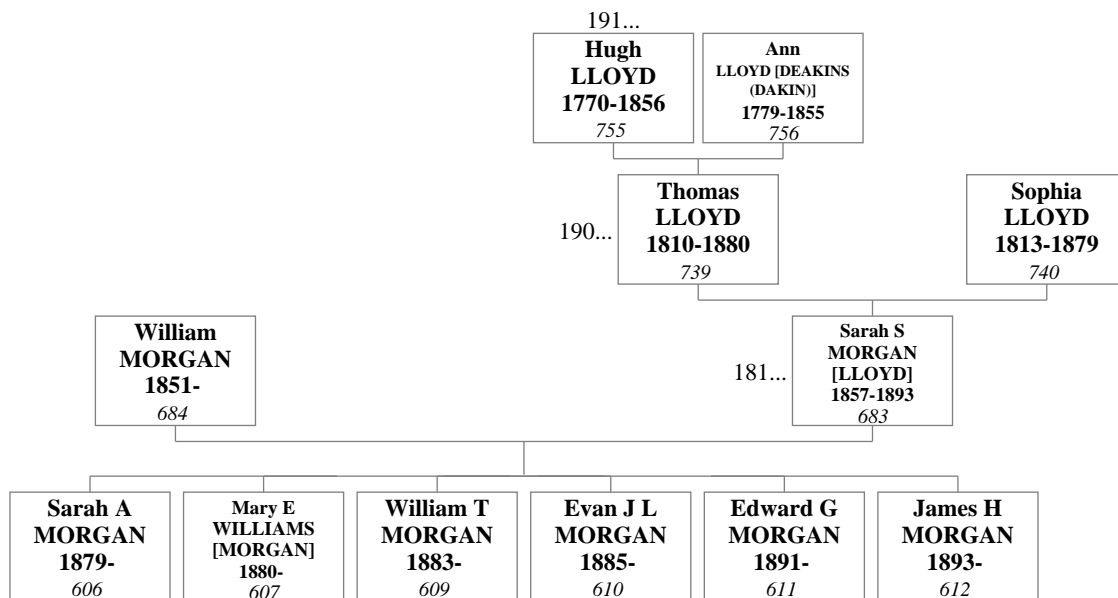

171. Thomas GRIFFITHS and Fortune GRIFFITHS [DAVIES]

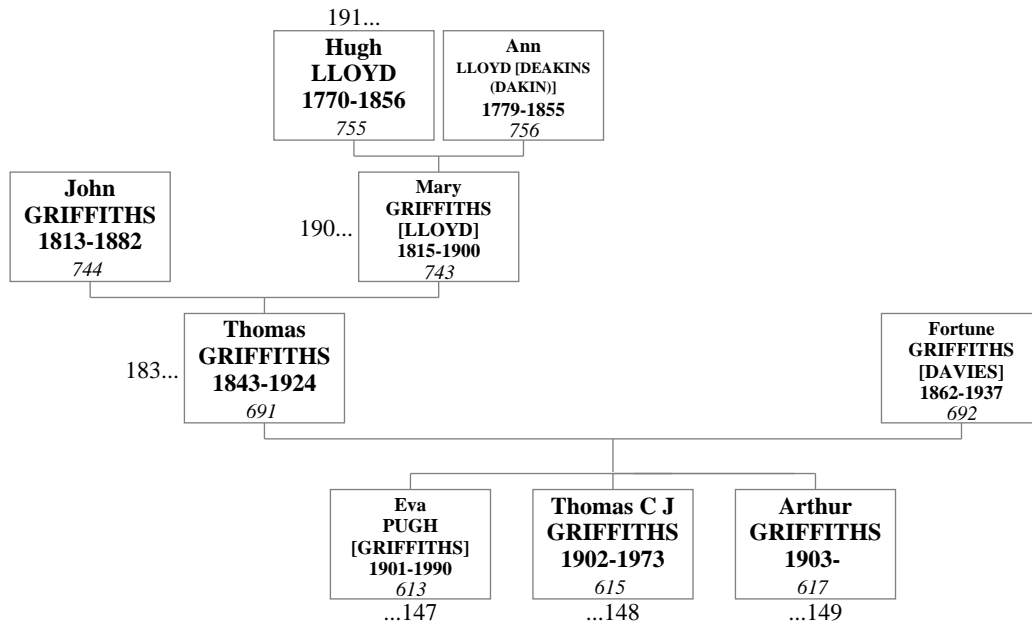

172. Sarah Ann LLOYD

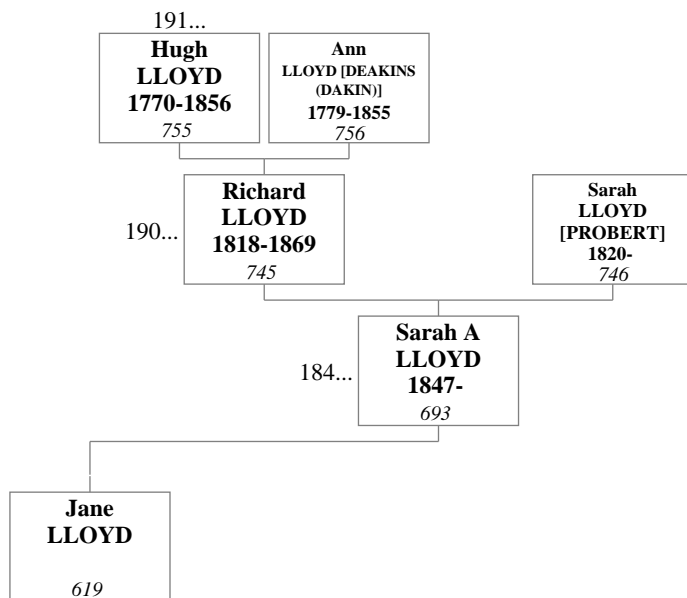

173. John LLOYD and Rachel LLOYD [REES]

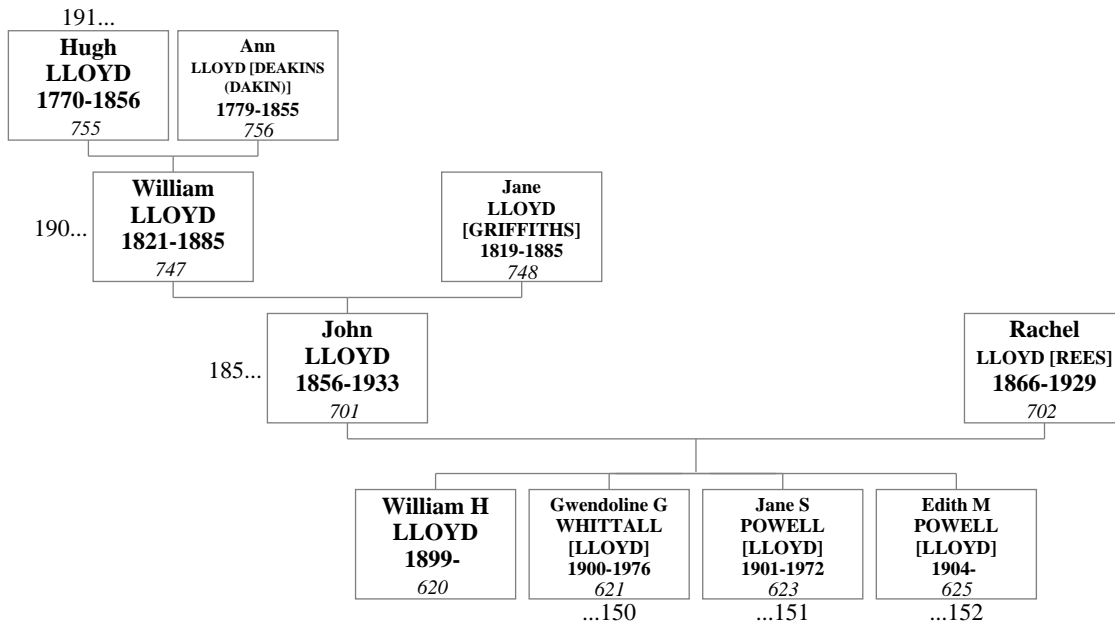

174. James LLOYD and Harriett LLOYD [DREW]

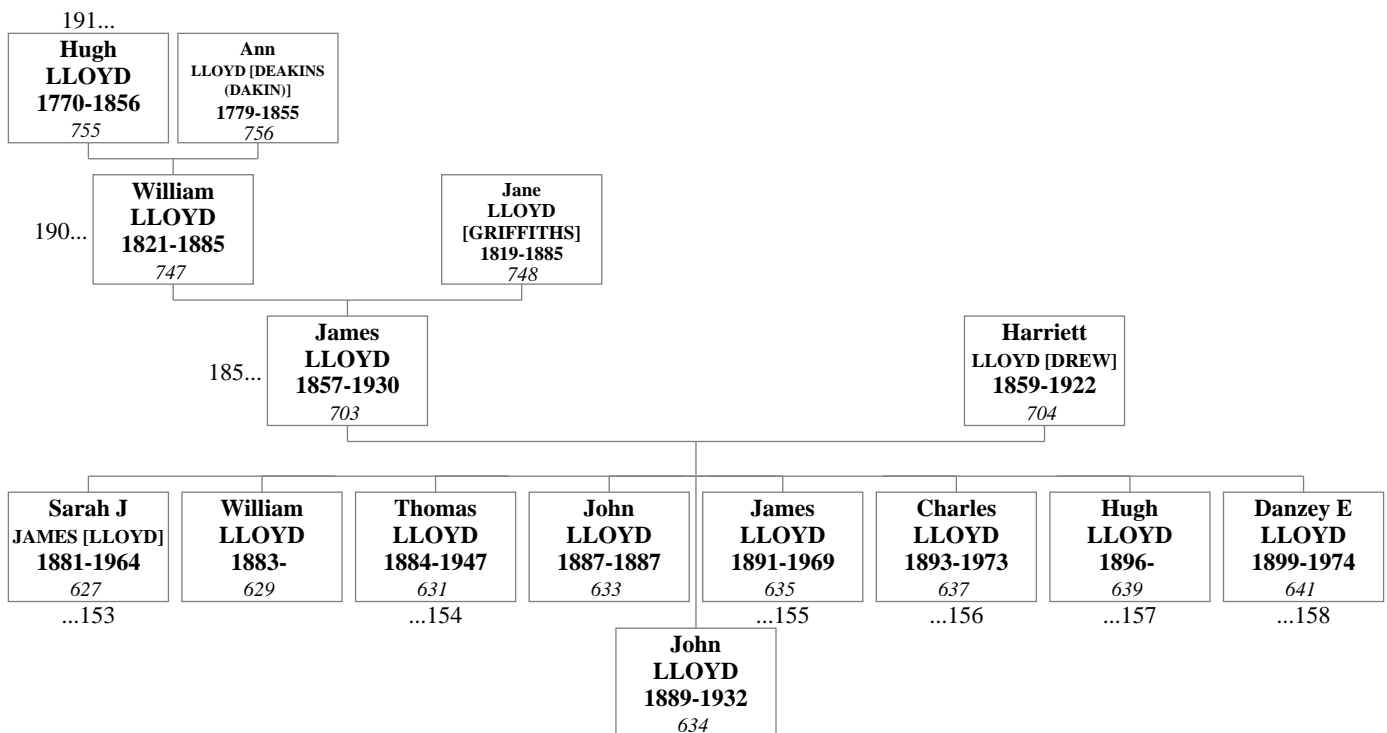

175. Hugh LLOYD and Margaret LLOYD [REES]

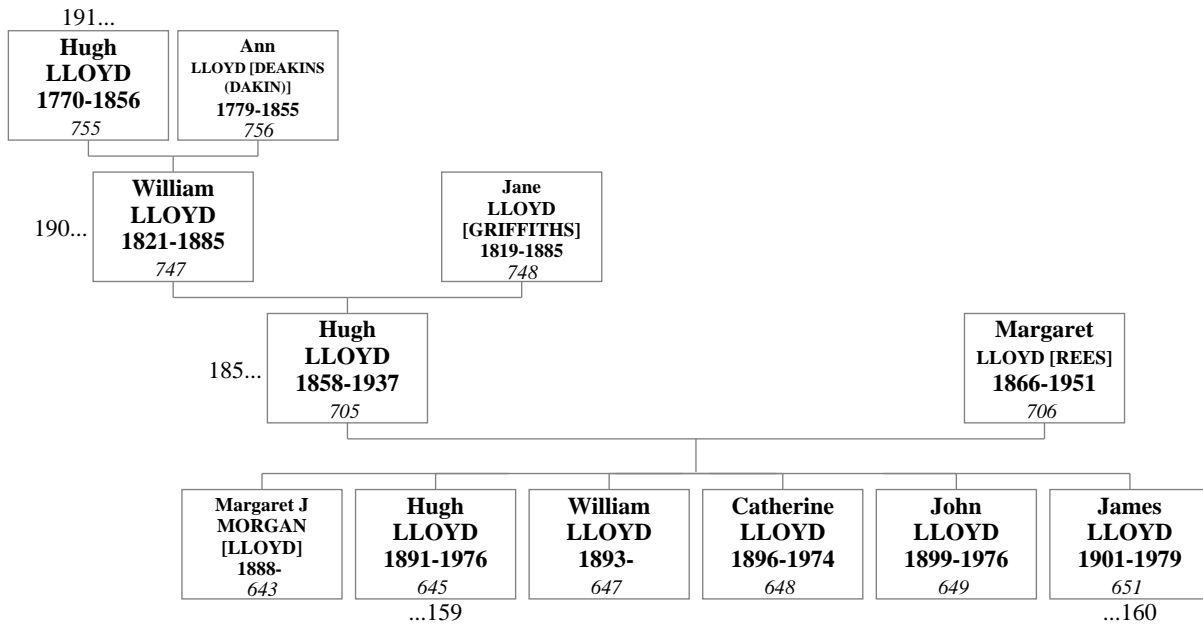

176. Thomas LLOYD and Sarah Ann LLOYD [HARVARD]

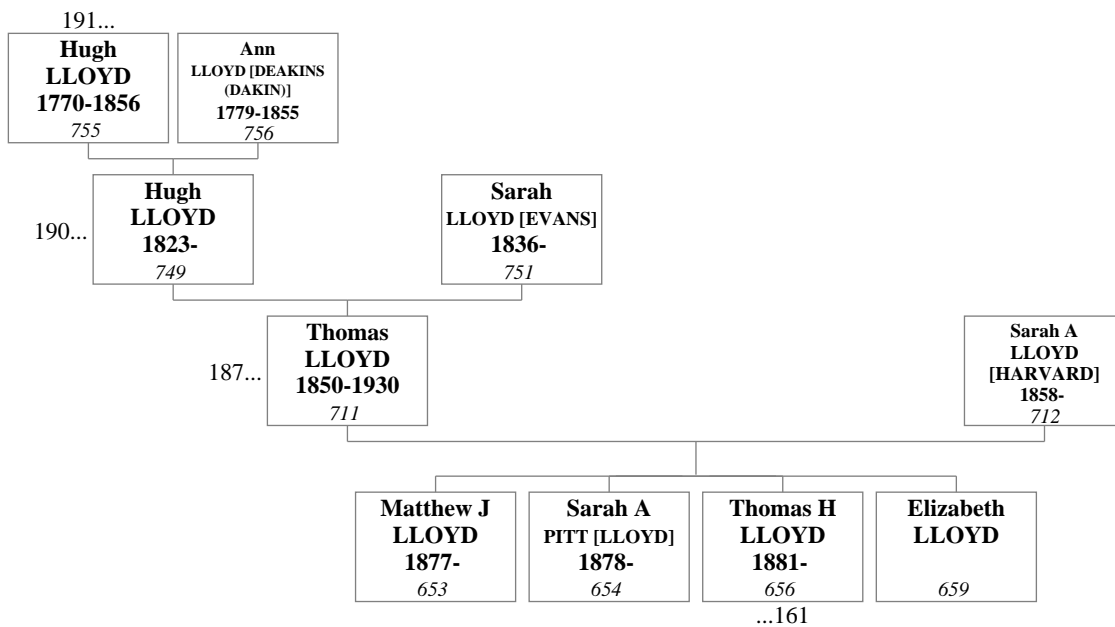

177. Edward Lewis LLOYD and Catherine LLOYD [POWELL]

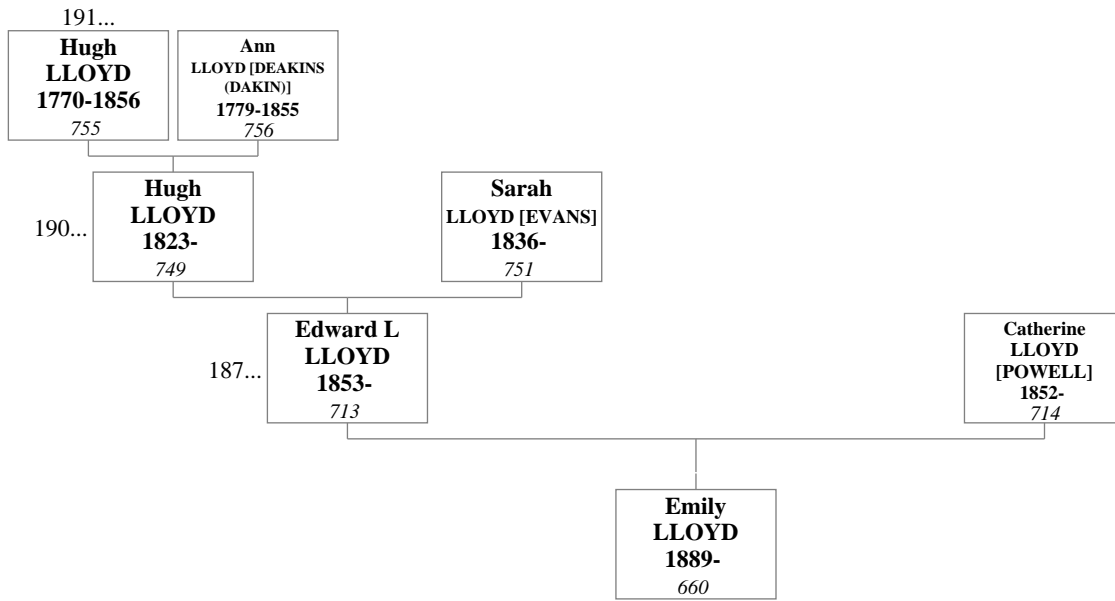

178. Evan LLOYD and Emma Eliza LLOYD [BOND]

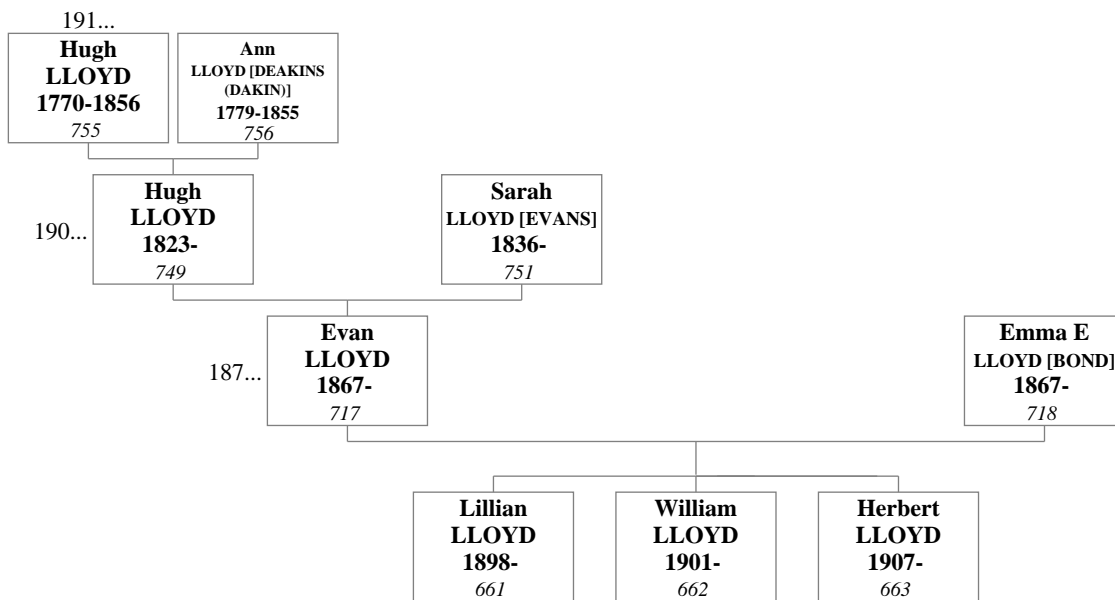

179. David Thomas MEREDITH and Elizabeth MEREDITH [LLOYD]

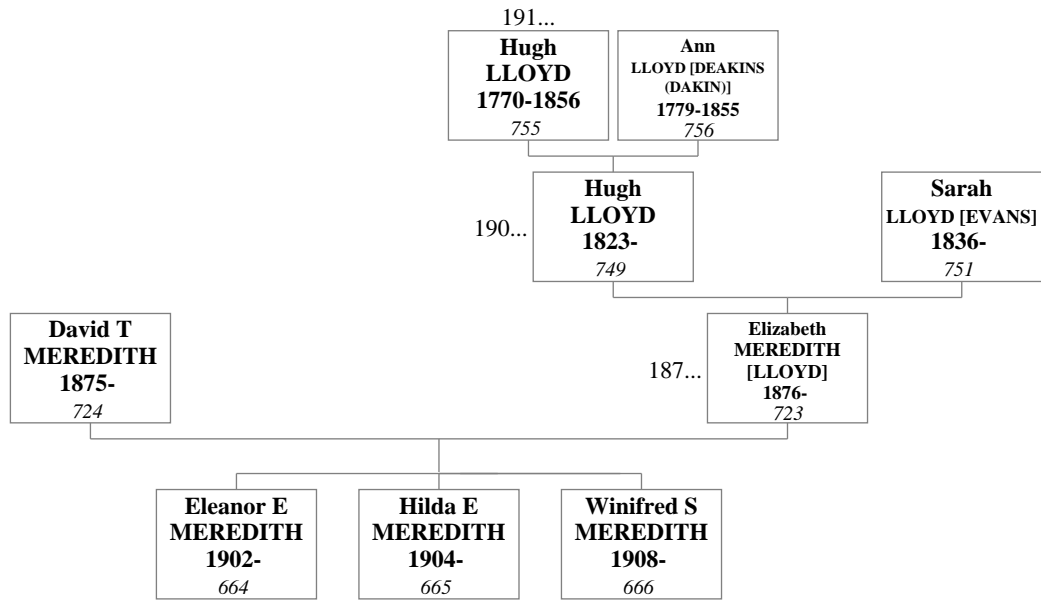

180. John LLOYD and Ann LLOYD [MAINWARING]

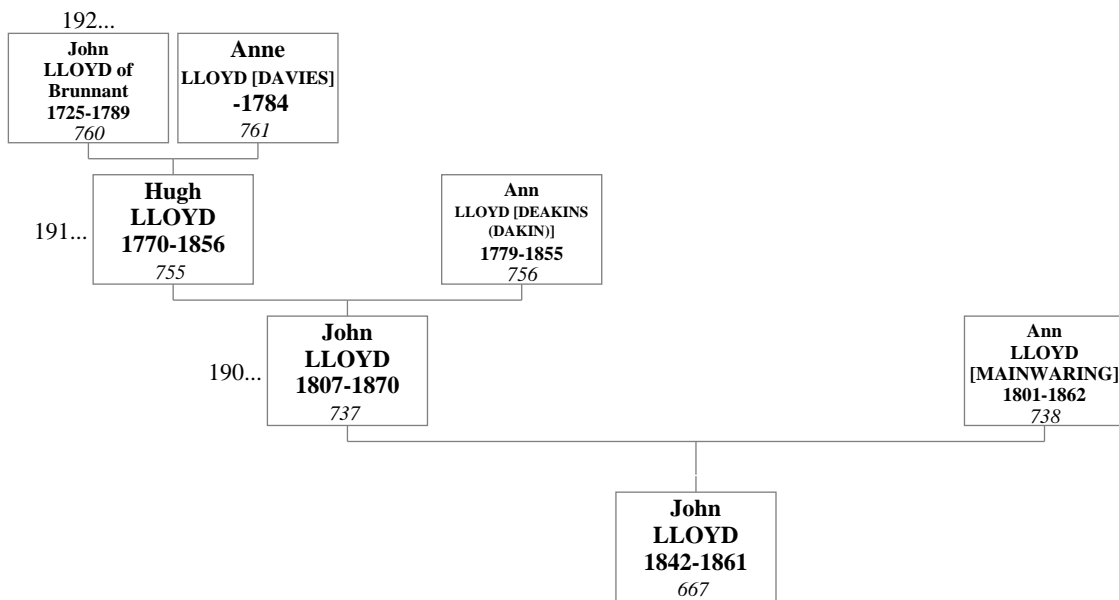

181. Thomas LLOYD and Sophia LLOYD

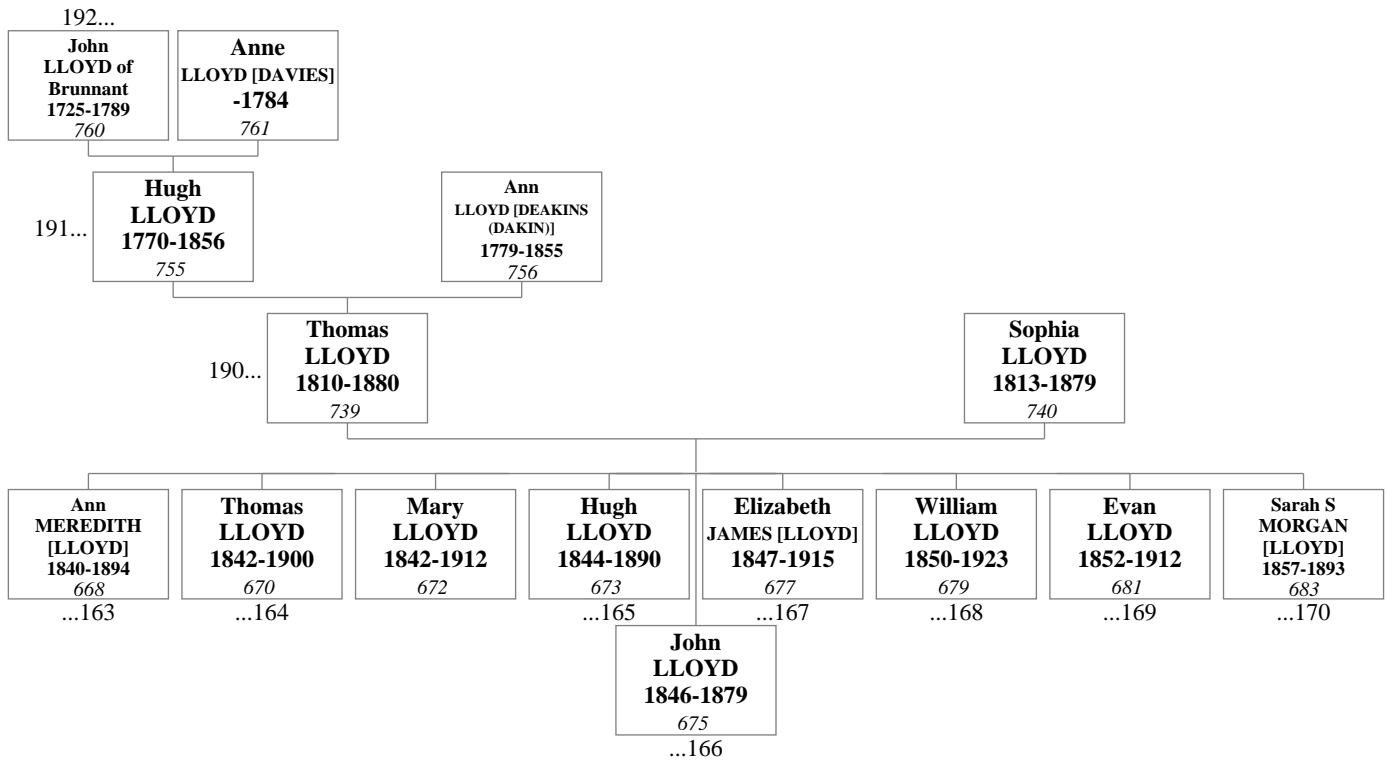

182. John DAVIES and Ann DAVIES [LLOYD]

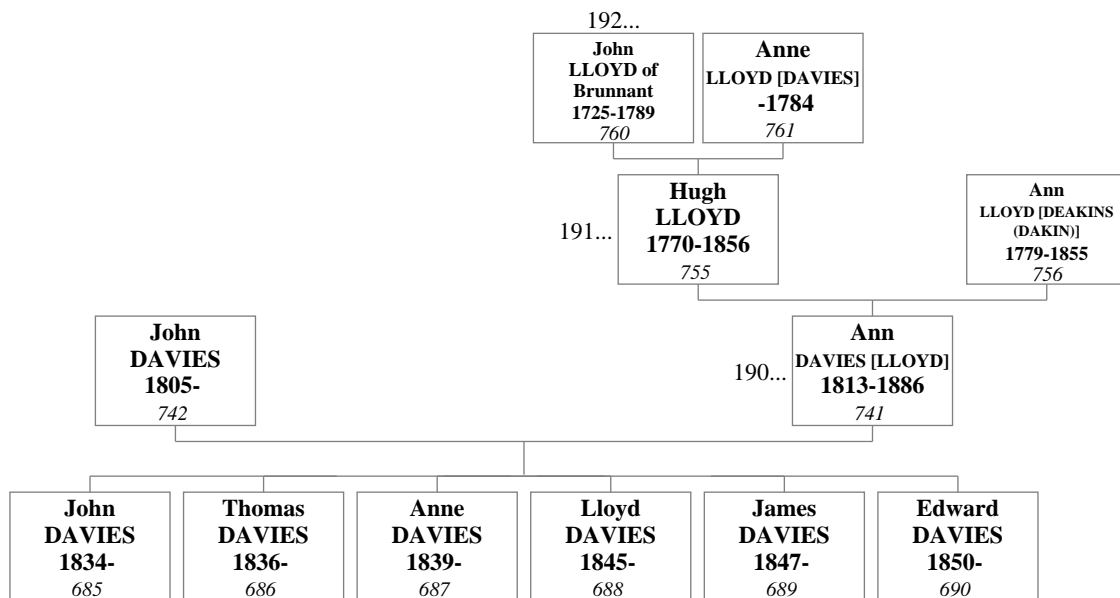

183. John GRIFFITHS and Mary GRIFFITHS [LLOYD]

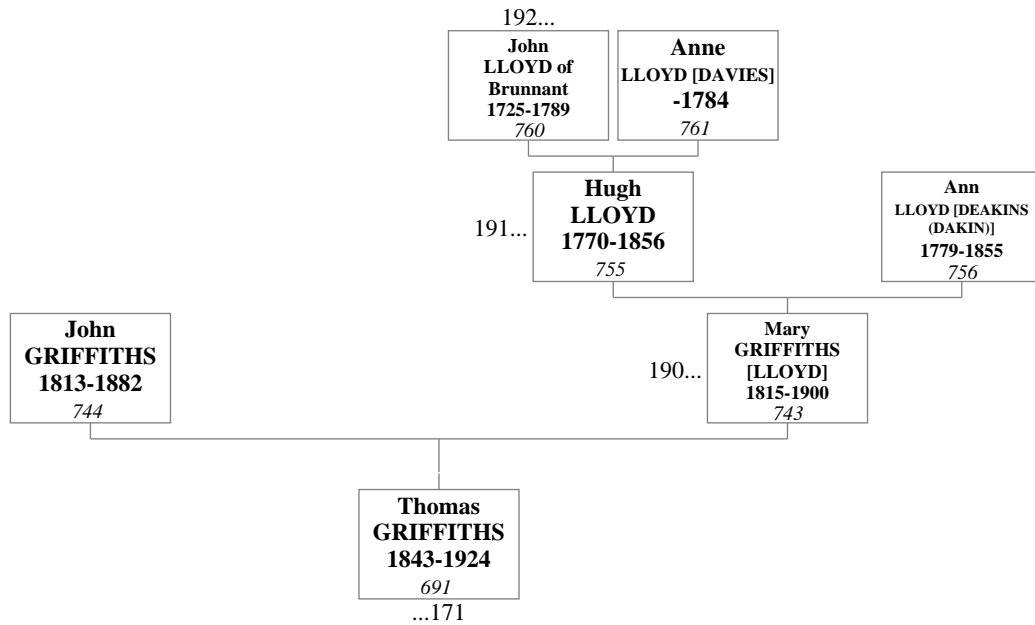

184. Richard LLOYD and Sarah LLOYD [PROBERT]

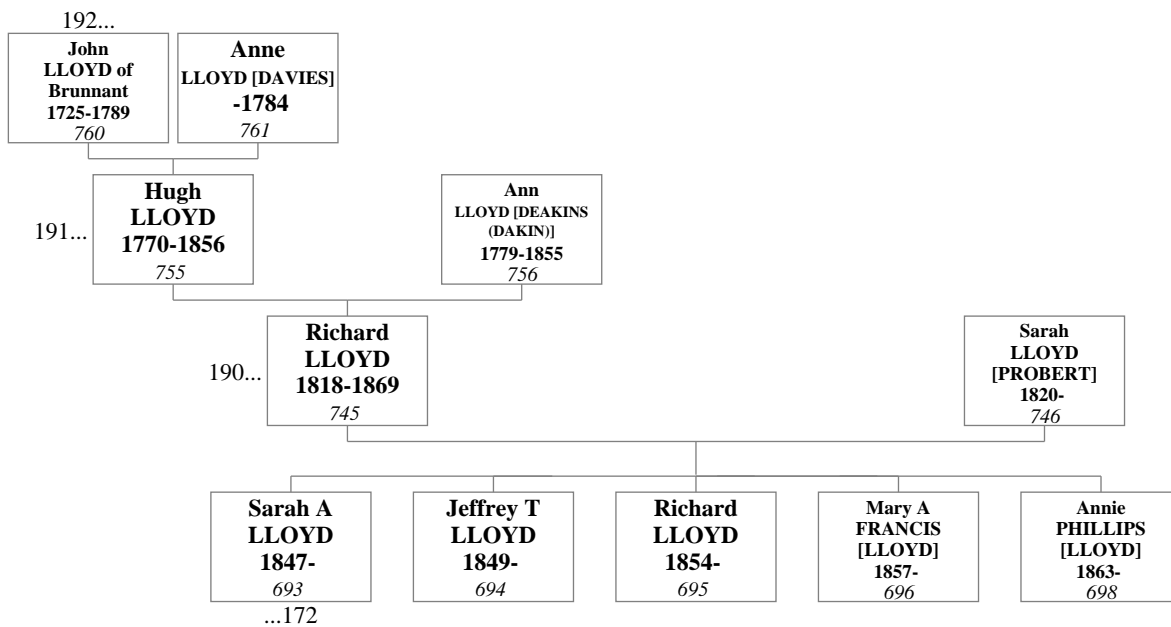

185. William LLOYD and Jane LLOYD [GRIFFITHS]

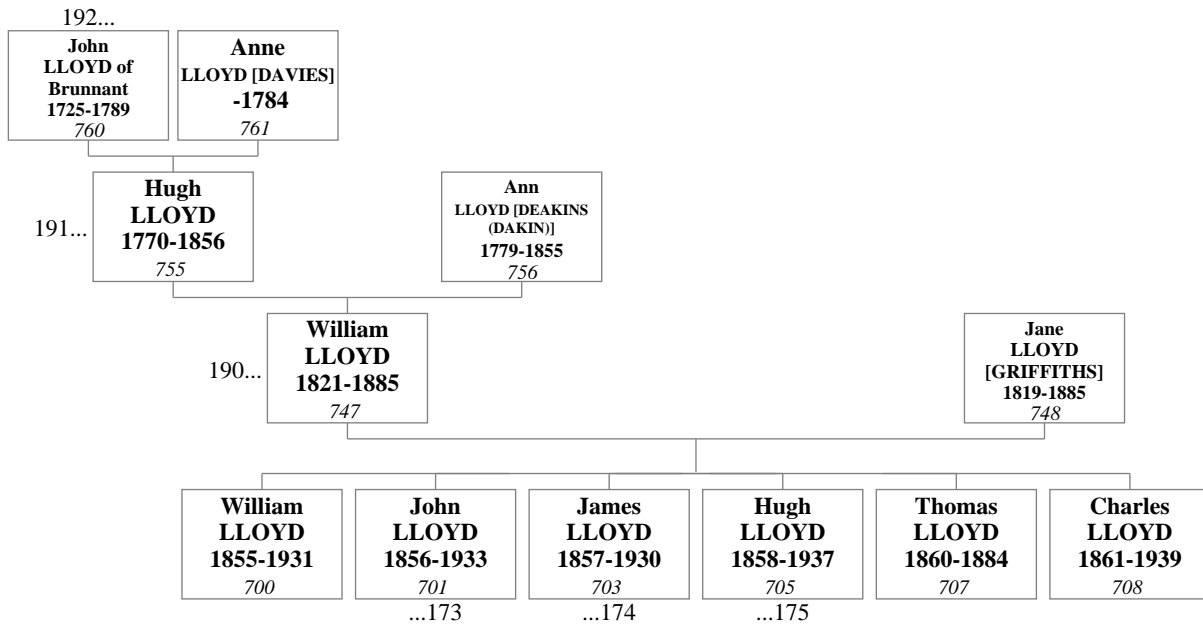

186. Hugh LLOYD and Elizabeth LLOYD [LEWIS]

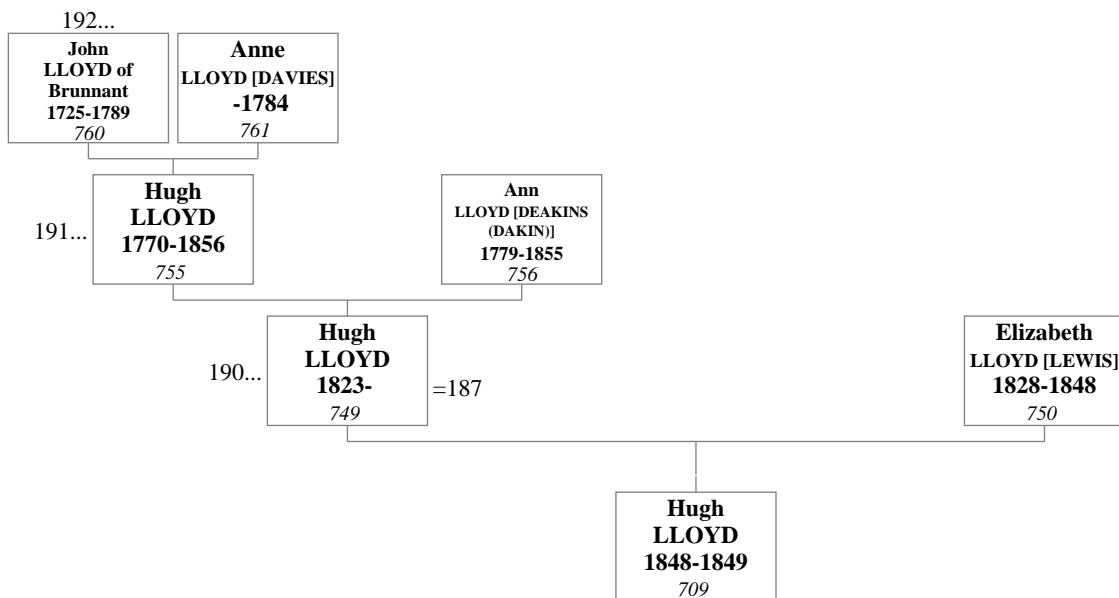

187. Hugh LLOYD and Sarah LLOYD [EVANS]

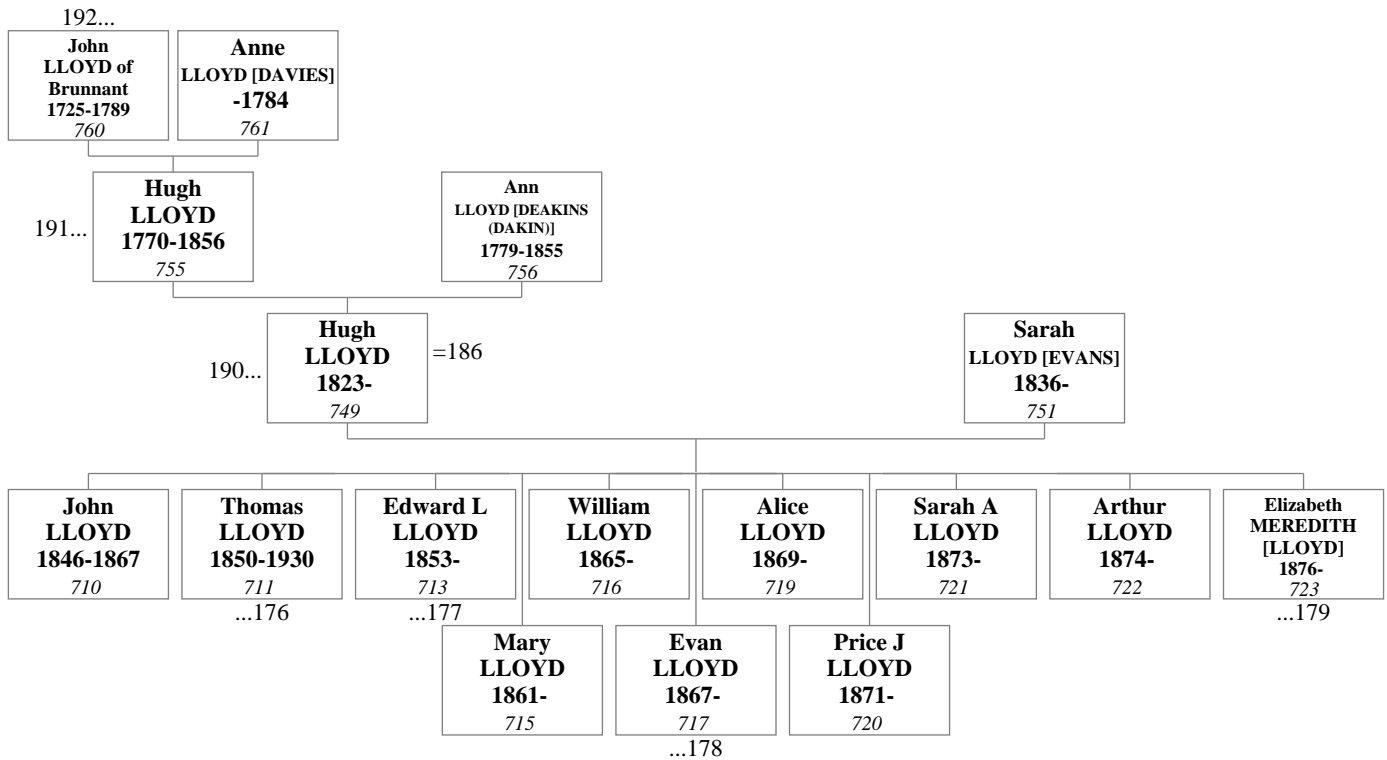

188. James EVANS and Sarah EVANS [LLOYD]

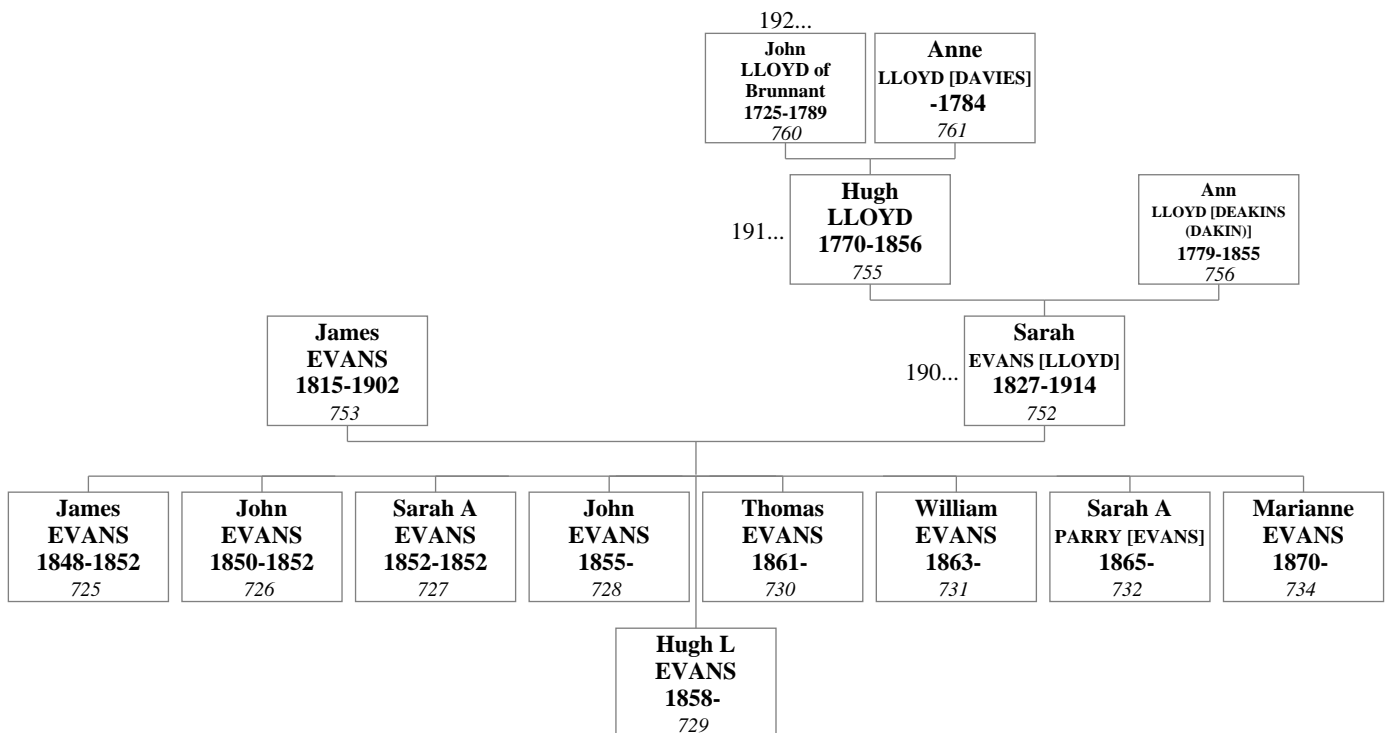

189. David LLOYD

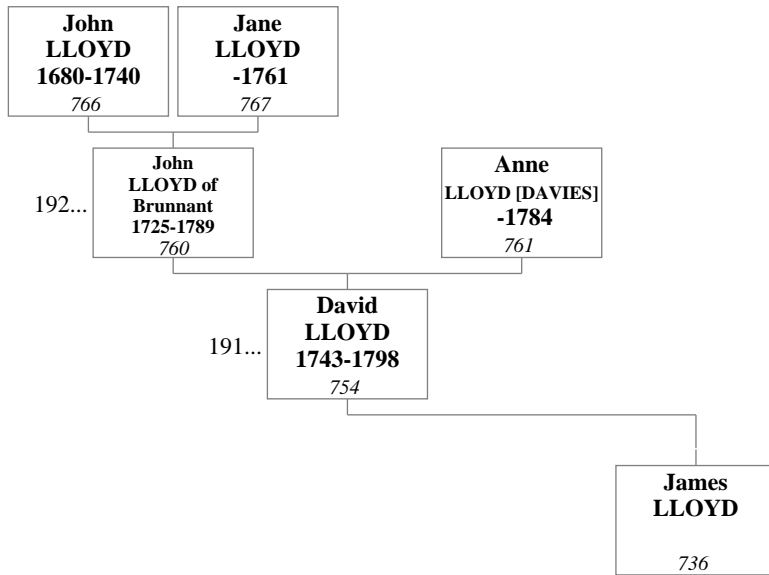

190. Hugh LLOYD and Ann LLOYD [DEAKINS (DAKIN)]

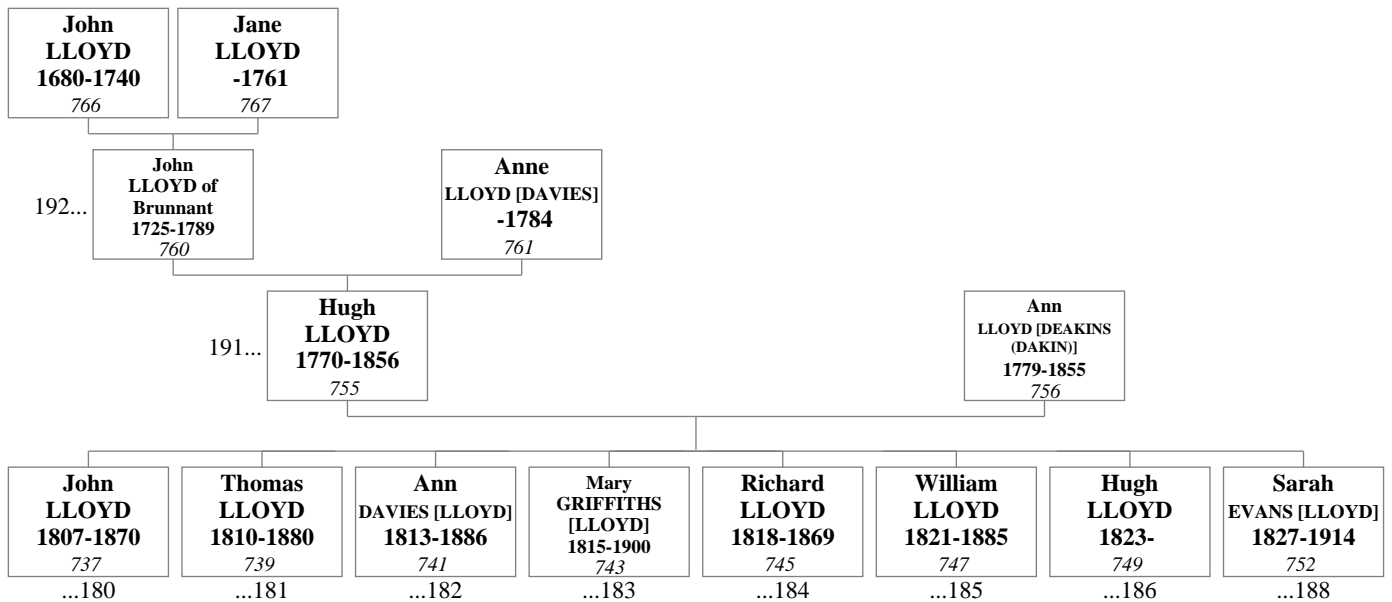

191. John LLOYD of Brunnant and Anne LLOYD [DAVIES]

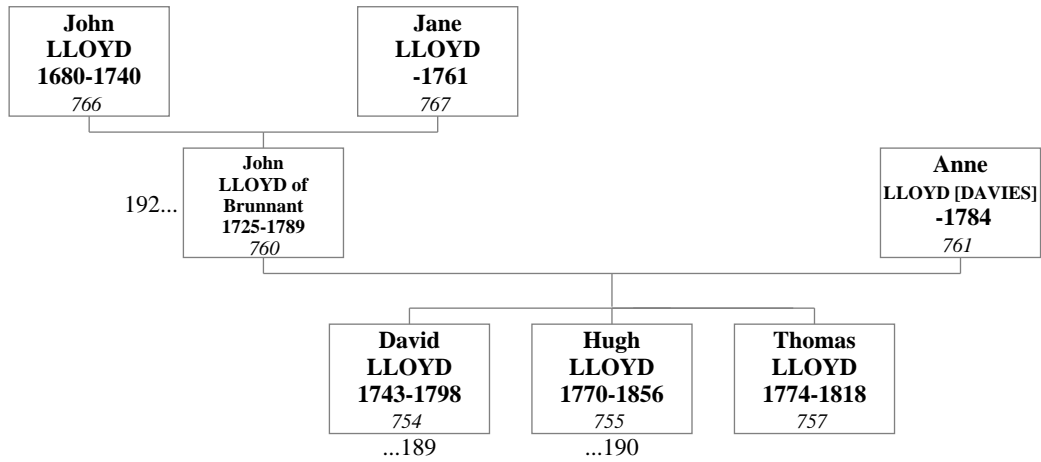

192. John LLOYD and Jane LLOYD

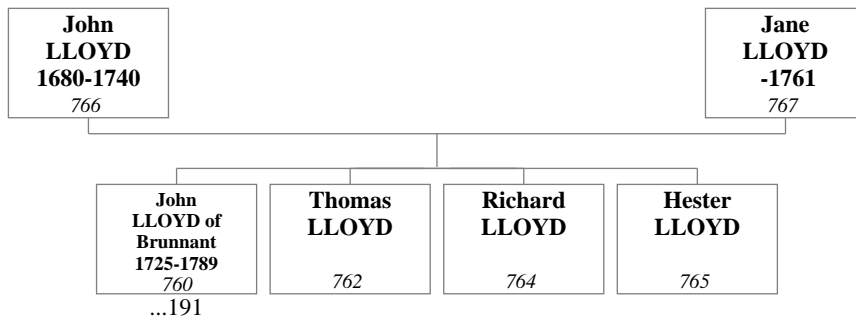

4. NOTES

1. Farmer at Hicks Farm, Presteigne
Applies to: Richard Mathew BYWATER⁶⁰.
2. Farming at Whitehouse, Onibury
Applies to: Sebastian BYWATER⁶⁵.
3. Lived at Boughwood
Applies to: Muriel Doreen LLOYD²⁷¹.
4. Meic Stephens, was born at Treforest, near Pontypridd, in 1938. Educated at University College, Aberystwyth, he was a French teacher and journalist before becoming Literature Director of the Welsh Arts Council in 1967. He founded Poetry Wales in 1965 and edited the magazine for eight years. A poet and editor of numerous books, he has become a university lecturer and a literary agent since retiring from the Arts Council. He is the editor of the Oxford Companion to the Literature of Wales (1986) and A Rhondda Anthology (1993), and translator of Gwynfor Evans' autobiography (1996). Meic Stephens teaches creative writing and journalism at the University of Glamorgan. He has written, edited or translated more than 150 books. He writes regularly for the Western Mail and the Independent. Author of "A Semester in Zion", published in 2003
Applies to: Meic STEPHENS MA Dlit²⁸¹.
5. Live in Kibworth
Applies to: Robert TURNER²⁹⁰.
6. Joined RN on 13 Sept 1978 at BRNC Dartmouth as a Midshipman. HMS HERMES Jan 79 - Apr 79 (Dartmouth Training Ship) HMCS PROTECTEUR Jul 80 - Dec 80 (Training) Based in Halifax, Nova Scotia HMS ARIADNE Jan 1981 - Jan 1982 (Training) HMS ILLUSTRIOUS Apr 1982 - Mar 1983 (Assistant Secretary) Ship came out of Build early from Swan Hunters Yard at Wallsend to participate in the Falklands War. The Argentinians surrendered during the Sea Trials. HMS DRYAD Apr 1983 - Dec 1984 (Assistant Secretary) HMS NEWCASTLE Jan 1985 - Apr 1986 (Deputy Supply Officer) took part in the evacuation of Aden in January 1986 during Gulf Deployment. And the rescue of a Soviet Pilot when his Forger VSTOL Aircraft crashed during exercises in the Barents Sea during the summer of 1985. HMS NEWCASTLE Apr 1986 - Apr 1987 (XO/SO Refit) HMS CENTURION Apr 1987 - Nov 1989 (Systems Analyst Naval Pay System) HMS BOXER Nov 89 - Apr 90 (Refit Supply Officer) with Cdr Tim Laurence, husband of the Princess Royal HMS ARROW Aug 1990 - Aug 1992 (Supply Officer) with Deployments to Falkland Islands, West Indies and was one of the first ships in to the Adriatic during the Bosnian War. Promoted Lt Cdr 1 Sep 1991 HMS ROOKE Oct 1992 to Aug 1995 (Base Supply Officer Gibraltar) DFS(CIS) Bath Oct 1995 - August 1998 (Systems Analyst & Application Support Officer) for Project UPKEEP HMS MONTROSE Aug 98 - Oct 00 (Squadron Supply Officer for 6th Frigate Squadron & Supply Officer). Deploying to the West Coast of the United States and the Bahamas for the first part of 1999 then to the Mediterranean and Black Seas for 2000 as part of the NATO Standing Naval Force. HMS RALEIGH Oct 2000 - Nov 2002 (Commodore's Secretary) Fleet HQ Nov 2002 - Aug 2006 (Logistics IT Projects Officer) 2003 Chartered Logistician 2005 Chartered IT Professional 2005 Chartered Engineer Aug 2006 Resigned from RN Aug 2006 Cyranes Consulting Ltd
Applies to: David Philip John LLOYD CEng, CITP, MBCS,, MAPM²⁹¹.
7. Trained as a Nurse with the Queen Alexandras Royal Naval Nursing Sisters, and was promoted to Nursing Officer in the Summer of 1983 as one of the Sisters in the Psychiatric Unit at RNH Haslar in Gosport, Hampshire. Left the QARNNS as a Senior Nursing Officer in Nov 1985. Following the birth of Emily, she worked as a Registered Child Minder until moving to Gibraltar, where she found employment in the Westminster Medical Clinic as a Stress Therapist. On return to UK in August 1995 she obtained employment at the Newbury manor Nursing Home near frome in Somerset. She also worked as a Volunteer helper for Bath NHS Trust assisting people to use their Hearing Aids correctly. On moving to Plymouth in 1998, she started work as Deputy Matron of a Nursing Home.
Applies to: Maria Alexandra LLOYD [BUBEAR] RGN RMN²⁹².
8. Trained as a Teacher at Westminster College, Oxford Went to Nepal, Pokhara, as a Teacher with the International Nepal Foundation from August 1997 - July 1998.
Applies to: Peter Geoffrey LLOYD²⁹³.
9. Practiced in: 1979 - 1980 Southampton 1980 - 1981 Germany 1982 - Present Cardiff
Applies to: Stephen Gareth LLOYD BSc, D.C³⁰⁶.
10. Taght in Kingham Hall School, Costwolds. Minister in Stoke St Gregory then Sandbach
Applies to: Peter Adrian LLOYD³⁰⁸.
11. After leaving the Police, she opened a Sports Shop in Llandrindod Well, then became the Road Safety Officer for Powys County Council. Heather had been working apparently for 10 years with an international and interdenominational mission group in Mozambique. (building a village shop among other things!) She had been home for a year after her

father's death and was preparing to return to Africa when some problems of a gynaecological nature which they'd thought sorted, reasserted themselves. She was having a very drastic radiotherapy treatment but suddenly collapsed while in hospital.

Applies to: Heather Joy LLOYD³¹⁰.

12. Took the tenancy at Whitehouse Farm in 1934
Applies to: Richard BYWATER³⁹⁸.
13. Died as a child
Applies to: Rosa Mary BYWATER⁴⁰¹.
14. Was a pioneer in her day in that she went to Birmingham University in the 1920s, and was I believe, Student Union Secretary
Applies to: Naomi MORRIS [BYWATER]⁴⁰⁷.
15. Died un-married
Applies to: Gladys Anne ROBERTS⁴¹⁹.
16. Lived at Blaenbedw
Applies to: Muriel Annie (Dolly) LLOYD⁴²⁴.
17. Living near Oswestry
Applies to: Mr. TAIT⁴²⁸.
18. 1. Was known as Arthur 2. Changed name by Deed Poll from Lloyd to Lloyd-Stephens in 1955
Applies to: Herbert Arthur LLOYD - STEPHENS⁴³⁴.
19. Lived at Bibury, Gloucestershire
Applies to: Aubrey PRITCHETT⁴³⁸.
20. Was killed whilst training as a fighter pilot in Canada, believe plane went into a spin and never recovered. Service Number 1165666 and buried in Lot 114, Block A, Section 27 of the Brandon Cemetery, Manitoba, Canada in the care of the Commonwealth War Graves Commission
Applies to: Laurence Walter Hugh LLOYD RAFVR⁴⁴¹.
21. Grew up at Zion House, Fownhope, Gloucestershire. Left school in 1941 at age 15 Worked in Cheltenham Borough Treasurer's Department Joined Army in December 1943, Royal Engineers Serving in India (Kalyan); Singapore; Java; Malaya and Palestine. Demobbed in December 1947. Worked as a Clerk in LLOYDS Bank, Northampton until December 1948, then as a supply teacher until August 1949 in the Northampton area. Trained as a teacher at Loughborough College. Taught at: Billston Grammar School Woking Grammar School Alcester Grammar School Beauchamp College Lancaster Boys School, Leicester Retired July 1987, but continued as a Lay Preacher with the Baptist Church. He also took up writing and had some of his work published, in particular a Poem called "Vice Versa" was published in the May 97 edition of a magazine called "Best of British". Died very suddenly of a Heart Attack, whilst taking part in his usual Friday afternoon swim at Market Harborough Leisure Center.
Applies to: John LLOYD⁴⁴³.
22. Left school in 1949 at age 18 and went to Avery Hill College from 1949 to 1951 studying PE and Geography, preparatory to teaching. Taught at Victoria School, Wellingborough (51 - 53) Knaphill Secondary, Surrey (53 - 57) Westfield Junior School, Woking (57 - 59) Kibworth Primary School (70 - 93)
Applies to: Beryl Kathryn LLOYD [MILLER]⁴⁴⁴.
23. Was evacuated from Cardiff to Blaenpeake June 1940 - July 1945. Taught from Sept 1947 to Dec 1948 in Cardiff then from Jan 1949 until July 1987 when he retired in Leominster.
Applies to: Sidney Walter Gordon LLOYD⁴⁵⁴.
24. Died as a baby
Applies to: Margaret PUGH⁴⁶⁶.
25. Died as a baby
Applies to: Barbara PUGH⁴⁶⁹.
26. Lives in the US
Applies to: John WHITTALL⁴⁸⁰.

27. Died aged 40 from a Brain Haemorage
Applies to: Derek ILES⁵⁰⁴.
28. Living in a Nursing Home in Shrewsbury (2005)
Applies to: Mary JAMES⁵⁰⁸.
29. Father of the Children was William Burgoyne of Lyonshall. The children were brought up as if they were the siblings of Mary,
Applies to: Mr. Unknown⁵⁰⁹.
30. Private, 4105413, 1Bn The Herefordshire Regiment, Kings Shropshire Light Infantry
Applies to: Graham Hugh LLOYD⁵³³.
31. Lived at Hay on Wye
Applies to: Mona LLOYD⁵³⁵.
32. Died after a period in the Mid Wales Hospital at Talgarth. Donations were given to the Heart and Chest Foundation
Applies to: Alice May (Diddy) LLOYD⁵³⁶.
33. Lived at Great Queb, Eardisley
Applies to: Hugh LLOYD⁵³⁸.
34. of Bockleton Farm, near Tewksbury
Applies to: Victor Evan PHILLIPS⁵⁴¹.
35. No relation Living at Llanishen in 1901
Applies to: Benjamin LLOYD⁵⁵².
36. In 1901 was living at Dolecanny Farm
Applies to: Thomas MEREDITH⁵⁵⁴.
37. Lived at Lea Hall, Knighton
Applies to: James Thomas (Tom) LLOYD⁵⁵⁸.
38. 1881 Census shows him living with his parents at Cwmbach, Llanwrthwl, Brecon, Wales
Applies to: Edmund Danzey DREW⁵⁶⁰.
39. Died un-married
Applies to: John Evan LLOYD⁵⁶⁵.
40. After the death of his parents, she was looked after by maternal grandparents, Margaret and Arthur Powell of New House/ Bungy's Head, Huntington. Hugh and Martha Powell are buried in the graveyard at Michaelchurch. Worked at Baynham Hall, at the flour mill in Hundred House and, latterly, as a market gardener in Hereford City, and farmed at Blaenbedw, Glascwm, before his retirement. Was Church Warden at St Davids Church, Glascwm. On retirement he went to live at Gladestry with his youngest daughter, he then remarried Miss S M Owen and then went to live in Hereford. One of his daughters died before him. His funeral was at Holmer Church.
Applies to: Hugh LLOYD⁵⁷³.
41. After the death of her parents, she was looked after by maternal grandparents, Margaret and Arthur Powell of New House/ Bungy's Head, Huntington. Hugh and Martha Powell are buried in the graveyard at Michaelchurch. Annie Sophia moved away from the district shortly after the birth of her child. In 1936, at the age of 46, she married a man named Alfred Cornelius Passant (1900-86) and they lived the rest of their lives at Great Harwood, near Shrewsbury
Applies to: Annie Sophia (aka Nancy) LLOYD⁵⁷⁷.
42. Their ashes are buried in the churchyard at Great Harwood
Applies to: Alfred Cornelius PASSANT⁵⁷⁹.
43. Herbert Arthur Lloyd was given away at the age of ten months; he was brought up in Merthyr Tydfil by a policeman named Stephens and his wife and was kept in ignorance of who his real parents were until he was about 26 years old.
Applies to: Annie Sophia (aka Nancy) LLOYD⁵⁷⁷ and Alfred Cornelius PASSANT⁵⁷⁹.
44. Died young, Grave is at the back of the Graveyard
Applies to: Anne LLOYD⁵⁸⁰.

45. In 1881 was living at "Little Rabber", Gladestry. Lived at Blaen Peake, Brilley Mountain There is a story that she worked in London for a Doctor, when the doctor died, he left her all his money, which amounted to a reasonable sum. She used this money to buy Thomas Lloyd, the Blacksmith, his forge. She had something of a reputation in her latter years as being a little "fearsome", at least to the younger generation. 1871 Census shows her name as "Ada Eliza"
*Applies to: Adeliza Ann LLOYD*⁵⁸³.
46. In 1881 was living at "Little Rabber", Gladestry. In 1901 was living at Empton Farm.
*Applies to: William Bayley LLOYD*⁵⁸⁴.
47. In 1881 was living at "Little Rabber", Gladestry. Changed her name to Martha Matilda.
*Applies to: Sophia Matilda (Tillie) EVES [LLOYD]*⁵⁸⁵.
48. In 1881 was living at "Little Rabber", Gladestry.
*Applies to: Elizabeth Anne (Annie) LANE [LLOYD]*⁵⁸⁷.
49. In 1881 was living at "Little Rabber", Gladestry. Lived at Blaenpeake, Brilley Mountain
*Applies to: Alice LLOYD*⁵⁸⁹.
50. In 1881 was living at "Little Rabber", Gladestry.
*Applies to: Charles LLOYD*⁵⁹⁰.
51. In 1901 was living at Empton Farm As a boy, he reputedly used to win marbles off the other boys in the area, then sold them back! In his late teens, he went to work in Haverford West, apparently whilst staying with a relative (Millward??)
*Applies to: Hugh LLOYD*⁵⁹².
52. Lived in Newchurch In 1901 was living at Castle Cottage aka "Salt Box"
*Applies to: Thomas John LLOYD*⁵⁹⁴.
53. In 1901 was living at Castle Cottage aka "Salt Box" Lived in Cardiff
*Applies to: Evan Sidney LLOYD*⁵⁹⁶.
54. Half Sister of Laura Kings who Married Hugh
*Applies to: Mabel LLOYD [KINGS]*⁵⁹⁷.
55. In 1901 was living at Castle Cottage aka "Salt Box" Known as Sally
*Applies to: Sarah Janet STRATTON [LLOYD]*⁵⁹⁸.
56. In 1901 was living at Empton Farm During the First World War he served as a Surgeon Sub Lieutenant in the RNVR before completing his training as a Surgeon at Guys Hospital in 1921 and for two years held various house appointments, including House Surgeon. For three years he was Assistant Medical Officer at Lambeth Hospital, then had two years in General practice in Middlesex. Then from 1930 until the 1940-41 Blitz he worked for the London County Council Health Department, including Deputy medical Superintendent at western Hospital in Fulham. During the Second World War he was a Captain in the Home Guard. After WW II he was a Doctor at Rockwood Hospital, Cardiff. He finished his Career in March 1957 as Deputy Commissioner Medical Service with the Ministry of Pensions in Cardiff, which included Chairmanship of the Medical Appeals Board. During this period he lived at the Royal Hotel, St Marys St, Cardiff He was Cremated at Hereford and the memorial Service was conducted in Kington. He was a Fellow of the Royal Society of Medicine (FRSM), Member of the British Medical Association (MBMA), Fellow of the Royal Society of Medical Officers (FRSMO) and Member of the Royal Sanitary Institute.
*Applies to: Evan Thomas LLOYD FRSM, MBMA, MRSI*⁶⁰¹.
57. In 1901 was living at Empton Farm
*Applies to: Elizabeth Florence LLOYD*⁶⁰².
58. In 1901 was living at Empton Farm
*Applies to: Annie Clara LLOYD*⁶⁰³.
59. Blanche is an interesting lady. She appears to have been married in Q2 1919 to Charles Masters in Kensington, not sure whether she was divorced or the marriage annulled. She re-married George Weaver in Q1 1920 at Crickhowell, he may have died in 1922, although I cannot be sure from the records that it was him.
*Applies to: Blanche PEVERILL*⁶¹⁶.
60. Known as "Janey the Mill" and lived at 'Halls Mill' (Now a holiday Cottage) on the river Arrow, post code HR5 3QA, up to the start of the first world war. Harold James was a Miller and was exempt from going to war but needed to increase output and so they moved to another mill on the river Arrow, not far away called Park Style Mill In 1901 was living at Llanhowell

Applies to: Sarah Jane (Janey) JAMES [LLOYD]⁶²⁷.

61. In 1901 was living at Llanhowell
Applies to: William LLOYD⁶²⁹.
62. In 1901 was living at Llanhowell
Applies to: Thomas LLOYD⁶³¹.
63. Lived at Newhouse, Bryngwyn In 1901 was living at Llanhowell
Applies to: John LLOYD⁶³⁴.
64. Lived at the Apostles In 1901 was living at Llanhowell
Applies to: James LLOYD⁶³⁵.
65. In 1901 was living at Llanhowell
Applies to: Charles LLOYD⁶³⁷.
66. In 1901 was living at Llanhowell
Applies to: Hugh LLOYD⁶³⁹.
67. Went to school at Gladestry (for 12 months) whilst living at Llanhowell. In 1901 was living at Llanhowell, then moved to Mahollam Farm where he failed at Huntington School. then stayed with his elder sister "Janey the Mill" at Halls Mill before moving to Apostles. Retired in 1967 to Cherry Trees having suffered ill health for over 30 years.. The exact nature of his health is not known, however donations at his funeral were made to: Cancer research Diabetes Heart Foundation
Applies to: Danzey Evan LLOYD⁶⁴¹.
68. In 1901 was living at Rowbatch Farm
Applies to: Margaret Jane MORGAN [LLOYD]⁶⁴³.
69. In 1901 was living at Rowbatch Farm Unveiled the Plaque in Michaelchurch on Arrow Church to the Memory of Hugh Lloyd (1771 - 1856) in 1969.
Applies to: Hugh LLOYD⁶⁴⁵.
70. of Little Brampton
Applies to: Susannah LLOYD [GODWIN]⁶⁴⁶.
71. In 1901 was living at Rowbatch Farm
Applies to: William LLOYD⁶⁴⁷.
72. In 1901 was living at Rowbatch Farm
Applies to: Catherine (Kitty) LLOYD⁶⁴⁸.
73. In 1901 was living at Rowbatch Farm
Applies to: John (Jack ?) LLOYD⁶⁴⁹.
74. In 1901 was shown as a Butcher and living with his Uncle Edward.
Applies to: Thomas Hugh LLOYD⁶⁵⁶.
75. Died un-married
Applies to: John LLOYD⁶⁶⁷.
76. 1881 Census shows them living at Llanshivor, Clyro, Radnor, Wales
Applies to: Samuel MEREDITH⁶⁶⁹.
77. Carried out his Bonesetting in BUILT Wells. 1881 Census shows him living at Bryn, Glaschwym, Radnor, Wales. Farmer of 190 acres employing one man (Thomas Price).
Applies to: Thomas LLOYD⁶⁷⁰.
78. Died un-married
Applies to: Mary LLOYD⁶⁷².
79. Was left Blaenbeddw Farm by his Father, Thomas Died in the Flu epidemic
Applies to: Hugh LLOYD⁶⁷³.

80. Died in the Flu epidemic
Applies to: Martha LLOYD [POWELL]⁶⁷⁴.
81. Lived at Llanpica
Applies to: John LLOYD⁶⁷⁵.
82. Lived at Vedw until Circa 1900 when they moved to Hergest, (James had gone insane) Bessie went to live with daughter after James death
Applies to: James JAMES⁶⁷⁸.
83. Lived at Pentwyn, Gladestry, also "Little Rabber" In 1901 was living at Castle Cottage aka "Salt Box" Throughout his life there was a progressive decline in the family circumstances, attributed to a number of reasons. The family moved from Pentwyn to Huntington where he became an "Agricultural labourer". His decline in status is recorded in the School register which shows Fathers Occupation, initially as Farmer then as Labourer and in the 1881 British Census as "unemployed". Finally lived in a cottage called "Saltbox" or "Castle Cottage"
Applies to: William LLOYD⁶⁷⁹.
84. In 1881 was living at "Little Rabber", Gladestry. Died at the age of 83, though for many years prior to that a knee injury prevented her from leaving the house. In 1901 was living at Castle Cottage aka "Salt Box"
Applies to: Sarah LLOYD [MILWARD]⁶⁸⁰.
85. In 1901 was living at Empton Farm Conducted Bonesetting in Kington, Leominster and Hereford.
Applies to: Evan LLOYD⁶⁸¹.
86. In 1901 was living at Empton Farm
Applies to: Clara LLOYD [HILL]⁶⁸².
87. By the 1901 Census, William had a large family and his wife Sara Sophia had died, possible giving birth to James or from complications thereafter. In 1901 William was shown as a Farm Labourer.
Applies to: William MORGAN⁶⁸⁴.
88. 1881 Census shows him living at Gwernybwh, Michaelchurch, Radnor, Wales 1901 Census shows him as "Retired Farmer" and living at Brywngwyn with Fortune Davies as his housekeeper.
Applies to: Thomas GRIFFITHS⁶⁹¹.
89. 1881 Census shows her living with her widowed Mother at New End Llanbedr-Paincastle, Radnor, Wales
Applies to: Fortune GRIFFITHS [DAVIES]⁶⁹².
90. The inclusion of a daughter is new. The 1891 Census identifies Jane Lloyd as "Daughter Of Housekeeper".
Applies to: Sarah Ann LLOYD⁶⁹³.
91. Worked as Agricultural Labourer at Upper Hengoed in 1881 Died un-married
Applies to: Richard LLOYD⁶⁹⁵.
92. Working as a domestic servant at the Crown Inn, Brilley in 1881
Applies to: Annie PHILLIPS [LLOYD]⁶⁹⁸.
93. In 1901 was living at Empton Farm The 1901 Census also shows three servants, Margaret(?) Davies (Housekeeper) aged 20, Charles Moss aged 20 and Alfred (?) aged 15.
Applies to: William LLOYD⁷⁰⁰.
94. Lived at a series of places including Apostles and Pentre Jack. He died whilst living with his daughter "Janey the Mill" In 1881 he was a Farmer and Bailiff, employing 1 (William Wade and living at Pentre Jack. In 1901 he was living at Llanhowell
Applies to: James LLOYD⁷⁰³.
95. In 1901 was living at Llanhowell
Applies to: Harriett LLOYD [DREW]⁷⁰⁴.
96. In 1901 was living at Rowbatch Farm employing one servant, Amy Jones aged 16.
Applies to: Hugh LLOYD⁷⁰⁵.
97. At the age of 15 she was working as a Domestic Servant at Bry owned by Thomas and Margaret Lloyd and then became the Housekeeper at Baynham Hall until her marriage at the age of 22. In 1901 was living at Rowbatch Farm

Applies to: Margaret LLOYD [REES]⁷⁰⁶.

98. In 1901 was living at Empton Farm
Applies to: Charles LLOYD⁷⁰⁸.
99. Lived at Crickhowell, used to practice Bonesetting in Hay on Wye. In 1911 (Census) was living as a Boarder at 4 Bewell St, Hereford and his profession listed as "Bonesetter"
Applies to: Thomas LLOYD⁷¹¹.
100. Lived at Pentrewed
Applies to: John LLOYD⁷³⁷.
101. Nee Griffiths
Applies to: Ann LLOYD [MAINWARING]⁷³⁸.
102. Lived at Cwmshenkin, Glascwm, then later at Lived at Empton from Circa 1860.
Applies to: Thomas LLOYD⁷³⁹.
103. from Llanfihangel in Elvei. No relation.
Applies to: Sophia LLOYD⁷⁴⁰.
104. Lived for a while at Dolan
Applies to: John DAVIES⁷⁴².
105. 1881 Census showed her living at Portway, Bryngwyn
Applies to: Mary GRIFFITHS [LLOYD]⁷⁴³.
106. 1881 Census showed him living at Portway, Bryngwyn
Applies to: John GRIFFITHS⁷⁴⁴.
107. Lived at Baynham Hall Listed in the 1881 British Census as "Farmer of 188 Acres" employing two servants - Thomas Havard and Elizabeth Vaughan.
Applies to: William LLOYD⁷⁴⁷.
108. Lived at Llanigon, later at Crickhowell Visited Hay On Wye To Practice
Applies to: Hugh LLOYD⁷⁴⁹.
109. Lived in Brilley at least until 1870 as all their surviving children are shown in the 1881 Census as having been born there. However, by the time of the Census they were living at Bryngwyn, Radnor
Applies to: Sarah EVANS [LLOYD]⁷⁵².
110. Farmer Of 140 Acres Employing 3 Servant Men - listed in the 1881 Census as Eliza A. PALMER (26) Servant Domestic, George DAVIES (26) General Servant (Indoor) and Samuel GREENWAY (22) General Servant (Indoor)
Applies to: James EVANS⁷⁵³.
111. Lived at Cwm Mawr until 1830, thereafter at Baynham Hall. (There is a Cwm Mawr on the North East side of Great Greaggau (See Locations Web Page) - is it the same one, if so it would tie in with Silver John)
Applies to: Hugh LLOYD⁷⁵⁵.
112. Brunnant was a sizeable Farm in Llandewi Ystradenni. In 1841 the Farm was still in existence, but had disappeared by 1881. John Lloyd left the farm to his nephew James Price in his will of 1789.
Applies to: John LLOYD of Brunnant⁷⁶⁰.
113. Farmed at Llandewi Ystradenni
Applies to: Richard LLOYD⁷⁶⁴.

5. INDEX OF PLACES

- 1939

Death of Mary Elizabeth BYWATER [THOMAS]³⁹⁹ in 1938.

(2 WEEKS)

Death of Sarah Ann EVANS⁷²⁷ in 1852.

(6 MONTHS)

Death of John LLOYD⁶³³ on 30 August 1887.

? ROAD ACCIDENT

Death of Alan JAMES⁷² in 1965.

AYLESBURY VALE

Birth of Laura Anne BOWS¹⁴⁸ in February 1989.

BANNEVILLE-LA-CAMPAGNE WAR CEMETARY

Burial of Graham Hugh LLOYD⁵³³.

BAYNHAM HALL

Birth of John LLOYD⁷³⁷ in 1807.

Death of Ann LLOYD [DEAKINS (DAKIN)]⁷⁵⁶ on 11 August 1855.

Death of Hugh LLOYD⁷⁵⁵ on 9 March 1856.

BEGUILDY

Burial of Edward HARRIS⁴¹⁴.

Burial of Joyce Sarah HARRIS [BYWATER]⁴¹³.

BLAENBEDDEW

Death of Mary LLOYD⁶⁷² on 26 March 1912.

BOLTON

Marriage of Mathew Sykes¹³⁸ and Jessica Alys Sykes [LLOYD]¹³⁷ on 6 September 2012.

BRAMPTON BRYAN

Burial of Constance Minnie DAVIES [BYWATER]⁴¹⁵.

Burial of Trevor Glyn DAVIES⁴¹⁶.

BRECKNOCKSHIRE, HAY

Death of Sarah Sophia MORGAN [LLOYD]⁶⁸³ in 1893.

Birth of David PUGH⁶¹⁴ in 1895.

Marriage of William Jones PARRY⁷³³ and Sarah Ann PARRY [EVANS]⁷³² in 1901.

Birth of Lesley M BASTIN [GRIFFITHS]⁴⁷⁰ in 1928.

Marriage of David PUGH⁶¹⁴ and Eva PUGH [GRIFFITHS]⁶¹³ in 1928.

Birth of Peter GRIFFITHS⁴⁷² in 1929.

Birth of Edward (Eddie) PUGH⁴⁶¹ in 1929.

Birth of Marjorie Sally SMITHERS [GRIFFITHS]⁴⁷³ in 1931.

Birth of Joyce Margaret DAVIES [PUGH]⁴⁶² in 1931.

Birth of Pamela M GRIFFITHS [GRIFFITHS]⁴⁷⁵ in 1932.

BRILLEY

Birth of Mary Ann (Polly) FRANCIS [LLOYD]⁶⁹⁶ in 1857.

Birth of Clara LLOYD [HILL]⁶⁸² in 1861.

BRYNGWYN

Birth of Thomas LLOYD⁷¹¹ on 31 August 1850.

Birth of Edward Lewis LLOYD⁷¹³ in 1853.

Birth of Arthur LLOYD⁷²² in 1874.

BUCKNELL

Birth of Caroline BYWATER [ANDERSON]⁶⁶.

CANADA

Death of Laurence Walter Hugh LLOYD RAFVR⁴⁴¹ on 20 April 1941.

CANADA12, MANITOBA, BRANDON CEMETERY

Burial of Laurence Walter Hugh LLOYD RAFVR ⁴⁴¹.

CAR ACCIDENT

Death of John Thomas BYWATER ²²⁴ in 1970.

CARDIFF

Birth of Sidney Walter Gordon LLOYD ⁴⁵⁴ on 1 September 1928.

Birth of Dilys LLOYD ⁴⁵⁶ in 1932.

Death of Evan Sidney LLOYD ⁵⁹⁶ on 31 March 1941.

Birth of Eleanor Joy HOLLAND [LLOYD] LLB (Oxon), LLM ¹⁵⁰ on 1 January 1985.

Birth of Kathryn Louise LLOYD BA, MA ¹⁵² on 19 November 1986.

Marriage of Geraint DAY ¹²¹ and Heledd Melangell DAY [STEPHENS] ¹²⁰ in August 2001.

CASCOB

Birth of Thomas LLOYD ⁷³⁹ in 1810.

CHARLTON KINGS BAPTIST CHURCH

Marriage of Sidney Walter Gordon LLOYD ⁴⁵⁴ and Peggy LLOYD [SIMMONS] ⁴⁵⁵ on 24 March 1951.

CHARLTON KINGS

Birth of Peggy LLOYD [SIMMONS] ⁴⁵⁵ on 25 February 1930.

CHELTENHAM

Marriage of Thomas LANE ⁵⁸⁸ and Elizabeth Anne (Annie) LANE [LLOYD] ⁵⁸⁷ in 1914.

Birth of John James LLOYD ¹⁴⁰ on 1 June 1999.

CIRENCESTER

Marriage of Aubrey E Michael PRITCHETT ²⁸⁵ and Janet PRITCHETT [BEASLEY] ²⁸⁶ in 1953.

Birth of Bruce PRITCHETT ¹³⁰ in 1957.

CLEHONGER

Birth of Eva Grace LLOYD [MORRIS] ⁵³⁹ on 12 April 1925.

CRICKHOWELL

Marriage of Thomas LLOYD ⁷¹¹ and Sarah Ann LLOYD [HARVARD] ⁷¹² in 1876.

Marriage of Edward Lewis LLOYD ⁷¹³ and Catherine LLOYD [POWELL] ⁷¹⁴ in 1879.

Birth of Thomas Hugh LLOYD ⁶⁵⁶ in 1881.

Birth of Beatrice Eva LLOYD [LEWIS] ⁶⁵⁸ in 1889.

Birth of Emily LLOYD ⁶⁶⁰ in 1889.

Marriage of Thomas Hugh LLOYD ⁶⁵⁶ and Eva May LLOYD [CLARKE] ⁶⁵⁷ in 1912.

Birth of Mildred LLOYD ⁵⁴⁶ in 1914.

Birth of Rosa J LLOYD ⁵⁴⁷ in 1916.

Birth of Arther E LLOYD ⁵⁴⁸ in 1922.

Marriage of Thomas Hugh LLOYD ⁶⁵⁶ and Beatrice Eva LLOYD [LEWIS] ⁶⁵⁸ in 1922.

Birth of Hilda E LLOYD ⁵⁴⁹ in 1924.

Birth of Edith A LLOYD ⁵⁵⁰ in 1926.

CWMMAWR

Christening of Hugh LLOYD ⁷⁵⁵ on 20 January 1771.

DENBIGHSHIRE, WREXHAM

Marriage of Hugh LLOYD ⁶⁷³ and Martha LLOYD [POWELL] ⁶⁷⁴ in 1885.

DEVON, LEW TRENCHARD

Christening of Karen Margaret LLOYD [DAWE] ²⁹⁴.

Marriage of Peter Geoffrey LLOYD ²⁹³ and Karen Margaret LLOYD [DAWE] ²⁹⁴ on 3 April 1993.

DEVON, TAVISTOCK

Birth of Karen Margaret LLOYD [DAWE] ²⁹⁴ on 15 June 1967.

DIPHTHERIA

Death of Rosa Mary BYWATER ⁴⁰¹.

DOLBEDWYN FARM

Birth of Elizabeth LLOYD [LEWIS] ⁷⁵⁰ in 1828.

EARDISLEY, GREAT QUEBB

Birth of Elwyn John LLOYD³⁷⁹ on 30 June 1952.

EARDISLEY, QUEBB FARM

Birth of Alan Hugh LLOYD³⁷⁷ on 29 November 1948.

EARLS BARTON BAPTIST CHURCH

Marriage of John LLOYD⁴⁴³ and Beryl Kathryn LLOYD [MILLER]⁴⁴⁴ on 30 July 1953.

EARLS BARTON

Birth of Beryl Kathryn LLOYD [MILLER]⁴⁴⁴ on 17 August 1931.

ENGLAND, HEREFORD, EARDISLEY

Birth of Margaret LLOYD [CONNOP]⁶⁷¹ in 1842.

Birth of James Thomas (Tom) LLOYD⁵⁵⁸ in 1866.

FOWNHOPE BAPTIST CHAPEL

Christening of John LLOYD⁴⁴³.

GLADESTRY, PENTWYN

Birth of James EVANS⁷⁵³ in 1815.

Marriage of William LLOYD⁶⁷⁹ and Sarah LLOYD [MILWARD]⁶⁸⁰ in 1869.

GLADESTRY

Birth of Elizabeth Anne (Annie) LANE [LLOYD]⁵⁸⁷ on 14 May 1876.

Birth of Alice LLOYD⁵⁸⁹ on 2 May 1878.

Birth of Charles LLOYD⁵⁹⁰ in 1880.

Birth of Hugh LLOYD⁶³⁹ in 1896.

GLAMORGAN

Birth of Winifred Sarah MEREDITH⁶⁶⁶ in 1908.

GLAMORGANSHIRE

Birth of Huw Meredydd STEPHENS¹²⁴ in May 1981.

GLANANT

Birth of Catherine LLOYD [POWELL]⁷¹⁴ in 1852.

GLASCOMBE

Birth of Hugh LLOYD⁷⁴⁹ in 1823.

GLASCWM, CWM MAWR

Birth of Ann DAVIES [LLOYD]⁷⁴¹ in 1813.

GLASCWM, CWMSHENKIN

Birth of William LLOYD⁶⁷⁹ in 1850.

Birth of Evan LLOYD⁶⁸¹ in 1852.

GLASCWM

Burial of Ann MEREDITH [LLOYD]⁶⁶⁸.

Burial of Mary LLOYD⁶⁷².

Burial of Samuel MEREDITH⁶⁶⁹.

Christening of John DAVIES⁷⁴² on 26 June 1805.

Birth of Mary GRIFFITHS [LLOYD]⁷⁴³ in 1815.

Birth of Richard LLOYD⁷⁴⁵ in 1818.

Birth of William LLOYD⁷⁴⁷ in 1821.

Birth of Samuel MEREDITH⁶⁶⁹ in 1828.

Birth of Ann MEREDITH [LLOYD]⁶⁶⁸ on 3 March 1840.

Birth of Thomas LLOYD⁶⁷⁰ in 1842.

Christening of Evan LLOYD⁶⁸¹ on 22 March 1852.

Birth of Sarah Sophia MORGAN [LLOYD]⁶⁸³ in 1857.

Marriage of Samuel MEREDITH⁶⁶⁹ and Ann MEREDITH [LLOYD]⁶⁶⁸ on 9 October 1858.

Birth of Elizabeth Ann (Eliza) LLOYD [MEREDITH]⁵⁵¹ in 1861.

Birth of Samuel MEREDITH⁵⁵³ in 1865.

Birth of Thomas MEREDITH⁵⁵⁴ in 1868.

GLASCWM (Continued)

- Birth of Margaret DREW [LLOYD]⁵⁵⁹ in 1868.
- Birth of Elizabeth DAVIES [LLOYD]⁵⁶¹ in 1870.
- Birth of Annie GOODWIN [MEREDITH]⁵⁵⁵ in 1871.
- Birth of Mary Ann (Polly) WILLIAMS [LLOYD]⁵⁶³ in 1872.
- Birth of John Evan LLOYD⁵⁶⁵ in 1876.
- Birth of Sarah Rosa BYWATER [LLOYD]⁵⁶⁶ in 1877.
- Birth of Ann Sophia ROBERTS [LLOYD]⁵⁶⁸ in 1880.
- Birth of Ada Agnes BYWATER [LLOYD]⁵⁷⁰ in 1883.
- Birth of Minnie Gladys LLOYD⁵⁷² in 1888.

GLOUCESTERSHIRE, DURSLEY

- Marriage of Aubrey PRITCHETT⁴³⁸ and Annie Matilda (Nan) PRITCHETT [EVES]⁴³⁷ in 1928.

GLOUCESTERSHIRE, LONGHOPE, ALL SAINTS CHURCH

- Marriage of Andrew Robert LLOYD RAF²⁹⁵ and Cheryl Esther LLOYD [DUGGAN]²⁹⁶ on 28 June 1997.

HAMPSHIRE, FAREHAM, HMS COLLINGWOOD

- Christening of Victoria Alexandra LLOYD¹³⁹.

HAMPSHIRE, FAREHAM, HMS SULTAN

- Christening of Jessica Alys Sykes [LLOYD]¹³⁷.

HAMPSHIRE, FAREHAM

- Birth of Jessica Alys Sykes [LLOYD]¹³⁷ on 4 March 1987.
- Birth of Victoria Alexandra LLOYD¹³⁹ on 11 October 1989.

HANTS, GOSPORT, ROYAL NAVAL HOSPITAL HASLAR, ST LUKE'S CHAPEL

- Marriage of David Philip John LLOYD CEng, CITP, MBCS., MAPM²⁹¹ and Maria Alexandra LLOYD [BUBEAR] RGN RMN²⁹² on 24 March 1984.

HAVERFORDWEST

- Christening of Hugh LLOYD⁵⁹².

HAY ON WYE, CHERRY TREES

- Death of Alice May (Diddy) LLOYD⁵³⁶ in March 1974.
- Death of Danzey Evan LLOYD⁶⁴¹ in 1974.

HAY ON WYE

- Marriage of Harry Arthur PITT ?⁶⁵⁵ and Sarah Ann PITT [LLOYD]⁶⁵⁴ in 1906.

HAY

- Marriage of Hugh LLOYD⁷⁴⁹ and Sarah LLOYD [EVANS]⁷⁵¹ in 1860.
- Birth of Mary LLOYD⁷¹⁵ in 1861.
- Marriage of Evan LLOYD⁷¹⁷ and Emma Eliza LLOYD [BOND]⁷¹⁸ in 1892.
- Birth of Lillian LLOYD⁶⁶¹ in 1898.
- Marriage of David Thomas MEREDITH⁷²⁴ and Elizabeth MEREDITH [LLOYD]⁷²³ in 1900.
- Birth of William LLOYD⁶⁶² in 1901.
- Birth of Herbert LLOYD⁶⁶³ in 1907.

HEREFORD, CLIFFORD

- Birth of William MORGAN⁶⁸⁴ in 1851.

HEREFORD, WELLINGTON

- Birth of Jane LLOYD [HYATT]³⁸⁰ on 11 June 1953.

HEREFORDSHIRE, FOWNHOPE

- Birth of John LLOYD⁴⁴³ on 12 June 1926.

HEREFORDSHIRE, ROSS

- Birth of Brian A S FISHER²²⁰ in 1931.

HEREFORDSHIRE

- Death of Trevor Glyn DAVIES⁴¹⁶ in November 1989.

KINGTON BAPTIST CHAPEL (BY LICENCE)

Marriage of Hugh LLOYD⁷⁰⁵ and Margaret LLOYD [REES]⁷⁰⁶ on 29 March 1888.

KINGTON

Burial of Evan Thomas LLOYD FRSM, MBMA, MRSI⁶⁰¹.
 Burial of Anne LLOYD⁵⁸⁰.
 Marriage of William LLOYD⁷⁴⁷ and Jane LLOYD [GRIFFITHS]⁷⁴⁸ in 1855.
 Marriage of James JAMES⁶⁷⁸ and Elizabeth (Bessie) JAMES [LLOYD]⁶⁷⁷ in 1871.
 Marriage of William MORGAN⁶⁸⁴ and Sarah Sophia MORGAN [LLOYD]⁶⁸³ in 1878.
 Marriage of James LLOYD⁷⁰³ and Harriett LLOYD [DREW]⁷⁰⁴ in 1881.
 Marriage of Edward Baker PHILLIPS⁶⁹⁹ and Annie PHILLIPS [LLOYD]⁶⁹⁸ in 1887.
 Marriage of John LLOYD⁷⁰¹ and Rachel LLOYD [REES]⁷⁰² in 1899.
 Marriage of Thomas LLOYD⁶³¹ and Margaret Jane LLOYD [PRITCHARD]⁶³² in 1910.
 Marriage of Henry (Harold) JAMES⁶²⁸ and Sarah Jane (Janey) JAMES [LLOYD]⁶²⁷ in 1910.
 Marriage of Charles LLOYD⁶³⁷ and Lily May (aka Doris) LLOYD [EVANS]⁶³⁸ in 1916.
 Marriage of James LLOYD⁶³⁵ and Sarah Ann LLOYD [HAMER]⁶³⁶ in 1916.
 Birth of John (Jack) E DUGGAN⁵²⁰ in 1917.
 Birth of Margeurite J MORGAN [JAMES]⁵¹² in 1921.
 Death of William LLOYD⁶⁷⁹ on 7 August 1923.
 Birth of Roland LLOYD⁵³⁴ in 1926.
 Marriage of William Baden POWELL⁶²⁶ and Edith Mary POWELL [LLOYD]⁶²⁵ in 1931.
 Birth of Lena Mary POWELL⁴⁹⁵ in 1932.
 Birth of Rita Hazel FARMER [JAMES]³⁵⁵ on 8 November 1932.
 Marriage of Thomas A MORGAN⁵¹³ and Margeurite J MORGAN [JAMES]⁵¹² in 1940.
 Marriage of Eithel Pugh POWELL⁴⁹⁶ and Lena Mary POWELL⁴⁹⁵ in 1958.
 Marriage of Graham C LLOYD³⁷¹ and Wendy LLOYD [WILLIAMS]³⁷² in 1974.

KNIGHTON

Death of Richard LLOYD⁶⁹⁵.
 Birth of Thomas FRANCIS⁶⁹⁷ in 1866.
 Marriage of Edmund Danzey DREW⁵⁶⁰ and Margaret DREW [LLOYD]⁵⁵⁹ in 1896.
 Marriage of William WILLIAMS⁵⁶⁴ and Mary Ann (Polly) WILLIAMS [LLOYD]⁵⁶³ in 1899.
 Marriage of Richard BYWATER⁵⁶⁷ and Sarah Rosa BYWATER [LLOYD]⁵⁶⁶ in 1899.
 Marriage of William Owen ROBERTS⁵⁶⁹ and Ann Sophia ROBERTS [LLOYD]⁵⁶⁸ in 1901.
 Birth of Rosa Mary BYWATER⁴⁰¹ in 1902.
 Birth of Adah Margaret BYWATER⁴⁰⁴ in 1903.
 Birth of James Albert ROBERTS⁴²⁰ in 1906.
 Marriage of William Edward DAVIES⁵⁶² and Elizabeth DAVIES [LLOYD]⁵⁶¹ in 1907.
 Birth of Ethel Elizabeth LLOYD⁵²⁷ in 1917.
 Birth of Charles G LLOYD⁵²⁸ in 1918.
 Death of Eva May LLOYD [CLARKE]⁶⁵⁷ in 1919.
 Birth of Edward (Ted) A LLOYD⁵²⁹ in 1921.
 Birth of Hilde LLOYD⁵³⁰ in 1924.
 Birth of Dorothy Mary LLOYD⁵³¹ in 1930.
 Marriage of James Albert ROBERTS⁴²⁰ and Annie ROBERTS [WILLIAMS]⁴²¹ in 1930.
 Birth of Marian Jane LLOYD⁵³² in 1934.

LEA HALL

Marriage of John BYWATER⁵⁷¹ and Ada Agnes BYWATER [LLOYD]⁵⁷⁰ in 1926.

LEDBURY

Birth of Lily May (aka Doris) LLOYD [EVANS]⁶³⁸ in 1894.

LEEDS

Death of Jack SINCLAIR⁴⁴⁶ on 15 January 2004.

LEICESTER

Birth of Andrew Robert LLOYD RAF²⁹⁵ on 28 October 1967.

LEICESTERSHIRE, KIBWORTH CEMETRY

Burial of John LLOYD⁴⁴³ on 27 January 1997.

LEOMINSTER BAPTIST CHAPEL

Marriage of Peter Adrian LLOYD³⁰⁸ and Catherine LLOYD [FOLEY]³⁰⁹ on 21 July 1984.

LINCOLN

Birth of Raymond George (Bill) BOWS BA⁴⁴⁸ on 17 June 1927.

LLANBADARN FAWR

Birth of Sarah LLOYD [PROBERT]⁷⁴⁶ in 1820.

LLANBEDR RADNOR

Birth of Sarah LLOYD [EVANS]⁷⁵¹ in 1836.

LLANCHANGES

Birth of David Thomas MEREDITH⁷²⁴ in 1875.

LLANDEWI YSTRADENNY

Marriage of John LLOYD of Brunnant⁷⁶⁰ and Anne LLOYD [DAVIES]⁷⁶¹ on 9 January 1741.

Marriage of Thomas LLOYD⁷⁶² and Hester LLOYD⁷⁶³ on 7 January 1743.

Birth of David LLOYD⁷⁵⁴ on 9 September 1743.

Birth of Hugh LLOYD⁷⁵⁵ in 1770.

Birth of Thomas LLOYD⁷⁵⁷ on 1 May 1774.

Death of Anne LLOYD [DAVIES]⁷⁶¹ on 20 October 1784.

Death of John LLOYD of Brunnant⁷⁶⁰ on 28 November 1789.

Death of David LLOYD⁷⁵⁴ on 5 May 1798.

Death of Thomas LLOYD⁷⁵⁷ on 1 May 1818.

LLANDRINDOD WELLS

Birth of Emily Elizabeth LLOYD [WILLOUGHBY]⁵⁷⁵ in 1883.

Death of Elizabeth Ann (Lizzie) DAVIES [JAMES]⁵⁸¹ on 4 October 1932.

LLANFIHANGELL

Birth of Sarah LLOYD [MILWARD]⁶⁸⁰ in 1849.

Birth of Adeliza Ann LLOYD⁵⁸³ on 22 July 1870.

Birth of William Bayley LLOYD⁵⁸⁴ on 16 October 1871.

Birth of Sophia Matilda (Tillie) EVES [LLOYD]⁵⁸⁵ on 29 November 1872.

LLANGUNLLO

Burial of Margaret LLOYD [CONNOP]⁶⁷¹.

Burial of James Thomas (Tom) LLOYD⁵⁵⁸.

Burial of Thomas LLOYD⁶⁷⁰.

Birth of Ann LLOYD [DEAKINS (DAKIN)]⁷⁵⁶ in 1779.

Marriage of Hugh LLOYD⁷⁵⁵ and Ann LLOYD [DEAKINS (DAKIN)]⁷⁵⁶ on 1 August 1806.

Christening of James EVANS⁷⁵³ on 2 June 1815.

LLANPICA

Death of John LLOYD⁶⁷⁵ on 27 May 1879.

LLANSANTFFRAED IN ELWEL

Marriage of Thomas LLOYD⁷³⁹ and Sophia LLOYD⁷⁴⁰.

Birth of Sophia LLOYD⁷⁴⁰ in 1813.

Birth of Jane LLOYD [GRIFFITHS]⁷⁴⁸ on 28 February 1819.

LLANSTEPHEN

Birth of Elizabeth MEREDITH [LLOYD]⁷²³ in 1876.

LLANVELLION

Birth of Matthew John LLOYD⁶⁵³ in 1877.

Birth of Sarah Ann PITT [LLOYD]⁶⁵⁴ in 1878.

LONDON, STRAND

Marriage of Thomas GRIFFITHS⁶⁹¹ and Fortune GRIFFITHS [DAVIES]⁶⁹² in 1901.

LYONSHALL

Burial of Margaret DREW [LLOYD]⁵⁵⁹.

Burial of Edmund Danzey DREW⁵⁶⁰.

MAIDENHEAD

Birth of Sarah Marie LLOYD [GOUGH]³⁷⁸ on 2 December 1952.

MARKET HARBOROUGH

Death of John LLOYD⁴⁴³ on 17 January 1997.

MELTON MOWBRAY

Birth of Naomi Ruth LLOYD¹⁴¹ on 21 September 2003.

MICHAELCHURCH

Burial of Sophia LLOYD⁷⁴⁰.

Burial of Charles LLOYD⁷⁰⁸.

Burial of Richard LLOYD⁷⁴⁵.

Burial of Thomas LLOYD⁷⁰⁷.

Burial of Sophia Matilda (Tillie) EVES [LLOYD]⁵⁸⁵.

Burial of John LLOYD⁶⁶⁷.

Burial of William Bayley LLOYD⁵⁸⁴.

Burial of Hugh LLOYD⁷⁵⁵.

Burial of Adeliza Ann LLOYD⁵⁸³.

Burial of Sarah LLOYD [MILWARD]⁶⁸⁰.

Burial of Margaret LLOYD [REES]⁷⁰⁶.

Burial of Edith LLOYD⁶⁰⁰.

Burial of William LLOYD⁷⁴⁷.

Burial of Thomas LLOYD⁷³⁹.

Burial of William LLOYD⁷⁰⁰.

Burial of Jane LLOYD [GRIFFITHS]⁷⁴⁸.

Burial of James LLOYD⁶³⁵.

Burial of Harriett LLOYD [DREW]⁷⁰⁴.

Burial of James LLOYD⁷⁰³.

Burial of William LLOYD⁶⁷⁹.

Burial of Charles LLOYD⁵⁹⁰.

Burial of John LLOYD⁶³³.

Burial of Hugh LLOYD⁷⁰⁵.

Burial of Alice LLOYD⁵⁸⁹.

Burial of Ann LLOYD [DEAKINS (DAKIN)]⁷⁵⁶.

Burial of Evan LLOYD⁶⁸¹.

Birth of Sarah EVANS [LLOYD]⁷⁵² in 1827.

Marriage of John DAVIES⁷⁴² and Ann DAVIES [LLOYD]⁷⁴¹ on 1 August 1833.

Marriage of John GRIFFITHS⁷⁴⁴ and Mary GRIFFITHS [LLOYD]⁷⁴³ on 2 August 1836.

Marriage of John LLOYD⁷³⁷ and Ann LLOYD [MAINWARING]⁷³⁸ on 27 September 1842.

Marriage of James EVANS⁷⁵³ and Sarah EVANS [LLOYD]⁷⁵² on 1 June 1848.

Birth of Richard LLOYD⁶⁹⁵ in 1854.

Birth of John LLOYD⁷⁰¹ in 1856.

Birth of Hugh LLOYD⁷⁰⁵ in 1858.

Birth of Thomas LLOYD⁷⁰⁷ in 1860.

Birth of Charles LLOYD⁷⁰⁸ in 1861.

Birth of Annie PHILLIPS [LLOYD]⁶⁹⁸ in 1863.

Death of John LLOYD⁷³⁷ on 29 June 1870.

Marriage of John LLOYD⁶⁷⁵ and Mary Ann LLOYD [DAVIES]⁶⁷⁶ on 24 November 1874.

Burial of John LLOYD⁶⁷⁵ on 31 May 1879.

Birth of William Henry LLOYD⁶²⁰ on 2 April 1899.

MONTGOMERYSHIRE, FORDEN

Birth of Alfred Cornelius PASSANT⁵⁷⁹ in 1900.

NARTYD

Birth of Sarah Ann LLOYD [HARVARD]⁷¹² in 1858.

NEWARK

Marriage of Robin LEWIS²⁹⁸ and Kathryn Ann LEWIS [BOWS] BMedSci , BM, BS²⁹⁷ in July 1986.

NEWCHURCH

Burial of Thomas John LLOYD⁵⁹⁴.

Birth of John LLOYD⁷¹⁰ on 10 November 1846.

NEWGATE

Birth of John DAVIES⁷⁴² in 1805.

NO RECORD FOUND

Marriage of Richard LLOYD⁷⁴⁵ and Sarah LLOYD [PROBERT]⁷⁴⁶.
 Marriage of Evan LLOYD⁶⁸¹ and Clara LLOYD [HILL]⁶⁸².

NORFOLK, DOCKING

Marriage of Ernest Edward EVES⁵⁸⁶ and Sophia Matilda (Tillie) EVES [LLOYD]⁵⁸⁵ in 1901.

NORTHAMPTONSHIRE, HARPOLE

Death of Hugh LLOYD⁵⁹² on 21 December 1963.
 Death of Laura LLOYD [KINGS]⁵⁹³ in 1986.

NOTTINGHAMSHIRE, MANSFIELD

Birth of Sarah Louise BOWS¹⁴⁷ in August 1986.

OLD RADNOR, WALTON, THE GREEN

Birth of Herbert Arthur LLOYD - STEPHENS⁴³⁴ on 25 February 1910.

OLD RADNOR

Birth of Sarah Ann LLOYD⁶⁹³ in 1847.
 Birth of Jeffrey Thomas LLOYD⁶⁹⁴ in 1849.
 Birth of Benjamin LLOYD⁵⁵² in 1861.

OXFORD, WITNEY

Birth of Bethany Esther LLOYD¹⁴² on 21 December 1999.

PONTYPRIDD

Birth of Alma LLOYD - STEPHENS [SYMES]⁴³⁵ in 1910.
 Marriage of Herbert Arthur LLOYD - STEPHENS⁴³⁴ and Alma LLOYD - STEPHENS [SYMES]⁴³⁵ in 1935.
 Birth of Gwenno Angaharad DAY³² in May 2002.

POOLE

Birth of Benjamin Thomas LEWIS¹⁴⁴ in July 1987.
 Birth of Rhiannon Jayne LEWIS¹⁴⁵ in November 1989.

PRESTEIGNE

Marriage of Hugh LLOYD⁷⁴⁹ and Elizabeth LLOYD [LEWIS]⁷⁵⁰ in 1846.
 Birth of Edward Baker PHILLIPS⁶⁹⁹ in 1858.
 Birth of Rachel LLOYD [REES]⁷⁰² in 1866.
 Marriage of Thomas LLOYD⁶⁷⁰ and Margaret LLOYD [CONNOP]⁶⁷¹ in 1866.

RHOS GOCH

Burial of James EVANS⁷⁵³.
 Burial of Alice May (Diddy) LLOYD⁵³⁶.
 Burial of Sarah EVANS [LLOYD]⁷⁵².

SHREWSBURY, GREAT HARWOOD

Burial of Annie Sophia (aka Nancy) LLOYD⁵⁷⁷.
 Burial of Alfred Cornelius PASSANT⁵⁷⁹.

SHROPSHIRE, CLUN

Birth of Richard BYWATER⁷⁶ in 1971.

SHROPSHIRE, LUDLOW

Birth of John (aka Jack) BYWATER⁴⁰⁵ in 1904.
 Birth of Richard David BYWATER²¹⁷ in 1935.
 Birth of Darinda M FISHER [BYWATER]²¹⁹ in 1936.
 Birth of Margaret LEWIS [BYWATER]²²¹ in 1938.
 Birth of Phyllis Anne BYWATER²²³ in 1945.
 Birth of John Thomas BYWATER²²⁴ in 1946.
 Birth of Daphne BYWATER²²⁵ in 1948.
 Marriage of Brian A S FISHER²²⁰ and Darinda M FISHER [BYWATER]²¹⁹ in 1957.
 Marriage of Gordon G LEWIS²²² and Margaret LEWIS [BYWATER]²²¹ in 1960.
 Birth of Richard Mathew BYWATER⁶⁰ in 1961.
 Marriage of Richard David BYWATER²¹⁷ and Joan S BYWATER [MARTIN]²¹⁸ in 1961.
 Birth of Rebecca BYWATER⁶² in 1963.
 Birth of Sebastian BYWATER⁶⁵ in 1968.

SHROPSHIRE, LUDLOW (Continued)

Death of John (aka Jack) BYWATER⁴⁰⁵ in 1971.
 Death of Doris BYWATER [WATKINS]⁴⁰³ in 1976.

SOMERSET, KEYNSHAM

Birth of Maria Alexandra LLOYD [BUBEAR] RGN RMN²⁹² on 28 March 1956.

SOUTH GLAMORGAN

Marriage of Gareth EVANS¹¹⁹ and Lowri Angharad EVANS [STEPHENS]¹¹⁸ in August 1991.
 Marriage of Aron EVANS¹²³ and Brengain Gwenllian EVANS [STEPHENS]¹²² in September 1992.

SOUTHAMPTON

Birth of Emily Rebekah LLOYD¹³⁶ on 19 January 1986.

SURREY, GUILDFORD

Birth of David Philip John LLOYD CEng, CITP, MBCS., MAPM²⁹¹ on 9 September 1959.

SURREY, WARLINGHAM

Birth of Juliet LLOYD [DENMAN] Grad Dip TH³⁰⁷ on 14 March 1957.

SWANSEA

Marriage of Thomas John LLOYD⁵⁹⁴ and Catherine LLOYD [JONES]⁵⁹⁵ in 1916.

TOPPLESFIELD

Birth of Susan BYWATER [PRIEST]⁶¹.

TREFOREST

Birth of Meic STEPHENS MA Dlit²⁸¹ in 1938.

UK, BRECKNOCK

Marriage of Thomas Clement J GRIFFITHS⁶¹⁵ and Blanche PEVERILL⁶¹⁶ in 1927.
 Marriage of Richard Roger THOMAS⁷⁸ and Gwendoline THOMAS [RODERICK]⁷⁹ in November 1998.

UK, BRILLY MOUNTAIN, BLAENPEAK

Birth of John EVANS⁷²⁸ in 1855.
 Birth of Hugh Lloyd EVANS⁷²⁹ in 1858.
 Birth of Thomas EVANS⁷³⁰ in 1861.
 Birth of William EVANS⁷³¹ in 1863.
 Birth of Sarah Ann PARRY [EVANS]⁷³² in 1865.
 Birth of Marianne EVANS⁷³⁴ in 1870.
 Death of Sarah LLOYD [MILWARD]⁶⁸⁰ in 1932.

UK, CAMBRIDGE

Birth of Phillipa Anne WHATELEY¹⁰² in 1971.
 Birth of Benjamin Thomas Tristram HOLLAND MEng (Oxon)¹⁵¹ on 16 August 1985.

UK, EMPTON FARM

Death of Thomas LLOYD⁷³⁹ on 19 February 1880.
 Birth of Evan Thomas LLOYD FRSM, MBMA, MRSI⁶⁰¹ on 31 October 1887.
 Death of Evan Thomas LLOYD FRSM, MBMA, MRSI⁶⁰¹ on 22 December 1958.

UK, HEREFORD

Birth of Stephen Gareth LLOYD BSc, D.C³⁰⁶ on 23 September 1953.
 Birth of Catherine LLOYD [FOLEY]³⁰⁹ on 24 October 1956.
 Birth of Peter Adrian LLOYD³⁰⁸ on 25 November 1956.
 Birth of Heather Joy LLOYD³¹⁰ on 5 September 1959.
 Death of Hugh LLOYD⁵⁷³ in July 1968.
 Death of Heather Joy LLOYD³¹⁰ on 23 February 2008.

UK, HUNTINGTON

Birth of William LLOYD⁷⁰⁰ in 1855.
 Birth of James LLOYD⁷⁰³ in 1857.
 Birth of Hugh LLOYD⁵⁹² in October 1883.

UK, KENSINGTON

Birth of Kathryn Ann LEWIS [BOWS] BMedSci, BM, BS²⁹⁷ on 18 September 1956.

UK, LEOMINSTER

Birth of Constance Minnie DAVIES [BYWATER]⁴¹⁵ on 12 July 1916.
 Marriage of Edward HARRIS⁴¹⁴ and Joyce Sarah HARRIS [BYWATER]⁴¹³ in the 2nd quarter of 1937.
 Death of Richard BYWATER⁵⁶⁷ in 1963.
 Death of Constance Minnie DAVIES [BYWATER]⁴¹⁵ in February 1994.
 Death of Sidney Walter Gordon LLOYD⁴⁵⁴ on 18 October 2002.

UK, NORTHAMPTON

Marriage of David Kingsley LLOYD⁴⁴⁹ and Susan M LLOYD [MURRAY]⁴⁵⁰ in March 1985.

UK, OXFORD

Marriage of Benjamin Thomas Tristram HOLLAND MEng (Oxon)¹⁵¹ and Eleanor Joy HOLLAND [LLOYD] LLB (Oxon), LLM¹⁵⁰.
 Birth of Samuel Peter LLOYD¹⁵³ on 31 January 1986.

UK, RADNORSHIRE EAST

Marriage of William Thomas ROBERTS⁴¹⁷ and Doris ROBERTS [MASON]⁴¹⁸ in 1935.
 Marriage of William Caleb ROBERTS⁴²² and Mona A ROBERTS [PLAIN]⁴²³ in 1943.

UK, RADNORSHIRE, BRYNGWYN

Burial of John GRIFFITHS⁷⁴⁴.
 Birth of Sarah Anne MORGAN⁶⁰⁶ in 1879.
 Birth of Mary Elizabeth WILLIAMS [MORGAN]⁶⁰⁷ in 1880.
 Birth of William Thomas MORGAN⁶⁰⁹ in 1883.
 Birth of Eva PUGH [GRIFFITHS]⁶¹³ in 1901.
 Death of Fortune GRIFFITHS [DAVIES]⁶⁹² on 16 December 1937.

UK, RADNORSHIRE, CLYRO

Birth of Evan John Lloyd MORGAN⁶¹⁰ in 1885.
 Birth of Edward G MORGAN⁶¹¹ in 1891.
 Birth of James H MORGAN⁶¹² in 1893.

UK, SHREWSBURY

Birth of Theresa Louise AWAAD [FARMER]¹⁸⁰ in 1957.
 Birth of Adrian Oliver FARMER¹⁸² in 1962.
 Birth of Stephen K LEWIS⁶⁷ in 1963.
 Birth of Jane FARMER [TITLEY]¹⁸³ in 1965.
 Birth of Richard J LEWIS⁶⁸ in 1965.
 Birth of Rebecca Catherine FARMER⁵⁴ in 1988.
 Birth of Mathew James FARMER⁵⁵ in 1991.
 Birth of Anneli Rachel LEWIS¹⁴⁶ in August 1992.

UK, TAUNTON

Birth of Cheryl Esther LLOYD [DUGGAN]²⁹⁶ on 5 May 1964.
 Birth of Kezia Catherine Faith LLOYD¹⁵⁴ on 21 December 1998.

UNMARRIED

Marriage of Mr. Unknown⁵⁷⁸ and Annie Sophia (aka Nancy) LLOYD⁵⁷⁷.

WALES, BRECKNOCK, LLANWRTHWL

Birth of Edmundd Danzey DREW⁵⁶⁰ in 1866.

WALES, RADNORSHIRE, CEFNLLYS

Birth of Harriett LLOYD [DREW]⁷⁰⁴ in 1859.
 Birth of Fortune GRIFFITHS [DAVIES]⁶⁹² in 1862.
 Birth of Margaret LLOYD [REES]⁷⁰⁶ in 1866.

WANDSWORTH

Marriage of John Arthur STRATTON⁴⁵⁷ and Hannah Heslop STRATTON [MACAULAY]⁴⁵⁸ in 1944.

WARWICKSHIRE, ALCESTER

Birth of Peter Geoffrey LLOYD²⁹³ on 27 May 1962.

WEST BROMWICH

Marriage of Arthur STRATTON⁵⁹⁹ and Sarah Janet STRATTON [LLOYD]⁵⁹⁸ in 1918.

WESTBURY ON SEVERN

Birth of Annie Mabel (Nancy) BOWS [LLOYD] BA⁴⁴⁷ on 16 April 1931.

WORCESTERSHIRE, CATSHILL

Marriage of Hugh LLOYD⁵⁹² and Laura LLOYD [KINGS]⁵⁹³ on 29 March 1921.

Marriage of Evan Sidney LLOYD⁵⁹⁶ and Mabel LLOYD [KINGS]⁵⁹⁷ on 25 May 1926.

WORTHING

Marriage of Stephen Gareth LLOYD BSc, D.C.³⁰⁶ and Juliet LLOYD [DENMAN] Grad Dip TH³⁰⁷ on 3 September 1977.

YEOVIL

Birth of Blanche PEVERILL⁶¹⁶ in 1891.

6. INDEX OF DATES

- 1680** Birth of John LLOYD⁷⁶⁶.
- 1725** Birth of John LLOYD of Brunnant⁷⁶⁰.
- 1740** Death of John LLOYD⁷⁶⁶ on 9 June.
- 1741** Marriage of John LLOYD of Brunnant⁷⁶⁰ and Anne LLOYD [DAVIES]⁷⁶¹ on 9 January, in Llandewi Ystradenny.
- 1743** Marriage of Thomas LLOYD⁷⁶² and Hester LLOYD⁷⁶³ on 7 January, in Llandewi Ystradenny.
Birth of David LLOYD⁷⁵⁴ on 9 September, in Llandewi Ystradenny.
- 1761** Death of Jane LLOYD⁷⁶⁷ on 13 April.
- 1770** Birth of Hugh LLOYD⁷⁵⁵ in Llandewi Ystradenny.
- 1771** Christening of Hugh LLOYD⁷⁵⁵ on 20 January, in Cwmmawr.
Birth of John LLOYD⁷⁵⁹ on 17 March.
- 1774** Birth of Thomas LLOYD⁷⁵⁷ on 1 May, in Llandewi Ystradenny.
- 1779** Birth of Ann LLOYD [DEAKINS (DAKIN)]⁷⁵⁶ in Llangunllo.
- 1784** Death of Anne LLOYD [DAVIES]⁷⁶¹ on 20 October, in Llandewi Ystradenny.
- 1789** Death of John LLOYD of Brunnant⁷⁶⁰ on 28 November, in Llandewi Ystradenny.
- 1798** Death of David LLOYD⁷⁵⁴ on 5 May, in Llandewi Ystradenny.
- 1801** Birth of Ann LLOYD [MAINWARING]⁷³⁸.
- 1805** Christening of John DAVIES⁷⁴² on 26 June, in Glascwm.
Birth of John DAVIES⁷⁴² in Newgate.
- 1806** Marriage of Hugh LLOYD⁷⁵⁵ and Ann LLOYD [DEAKINS (DAKIN)]⁷⁵⁶ on 1 August, in Llangunllo.
- 1807** Birth of John LLOYD⁷³⁷ in Baynham Hall.
Christening of John LLOYD⁷³⁷ on 22 November.
- 1810** Birth of Thomas LLOYD⁷³⁹ in Cascob.
- 1813** Birth of John GRIFFITHS⁷⁴⁴.
Birth of Sophia LLOYD⁷⁴⁰ in Llansantffraed In Elwel.
Birth of Ann DAVIES [LLOYD]⁷⁴¹ in Cwm Mawr, Glascwm.
- 1815** Christening of James EVANS⁷⁵³ on 2 June, in Llangunllo.
Birth of James EVANS⁷⁵³ in Pentwyn, Gladestry.
Birth of Mary GRIFFITHS [LLOYD]⁷⁴³ in Glascwm.
- 1818** Death of Thomas LLOYD⁷⁵⁷ on 1 May, in Llandewi Ystradenny.
Birth of Richard LLOYD⁷⁴⁵ in Glascwm.
- 1819** Birth of Jane LLOYD [GRIFFITHS]⁷⁴⁸ on 28 February, in Llansantffraed in Elwel.
- 1820** Birth of Sarah LLOYD [PROBERT]⁷⁴⁶ in Llanbadarn Fawr.
- 1821** Birth of William LLOYD⁷⁴⁷ in Glascwm.
- 1823** Birth of Hugh LLOYD⁷⁴⁹ in Glascombe.
- 1827** Birth of Sarah EVANS [LLOYD]⁷⁵² in Michaelchurch.
- 1828** Birth of Elizabeth LLOYD [LEWIS]⁷⁵⁰ in Dolbedwyn farm.
Birth of Samuel MEREDITH⁶⁶⁹ in Glascwm.

- 1833**
Marriage of John DAVIES⁷⁴² and Ann DAVIES [LLOYD]⁷⁴¹ on 1 August, in Michaelchurch.
- 1834**
Birth of John DAVIES⁶⁸⁵.
- 1836**
Birth of Thomas DAVIES⁶⁸⁶.
Birth of Sarah LLOYD [EVANS]⁷⁵¹ in Llanbedr Radnor.
Marriage of John GRIFFITHS⁷⁴⁴ and Mary GRIFFITHS [LLOYD]⁷⁴³ on 2 August, in Michaelchurch.
- 1839**
Birth of Anne DAVIES⁶⁸⁷.
- 1840**
Birth of Ann MEREDITH [LLOYD]⁶⁶⁸ on 3 March, in Glascwm.
- 1842**
Christening of Thomas LLOYD⁶⁷⁰ on 1 May.
Christening of Mary LLOYD⁶⁷² on 1 May.
Birth of Thomas LLOYD⁶⁷⁰ in Glascwm.
Birth of Mary LLOYD⁶⁷².
Birth of Margaret LLOYD [CONNOP]⁶⁷¹ in Eardisley, Hereford, England.
Birth of John LLOYD⁶⁶⁷.
Marriage of John LLOYD⁷³⁷ and Ann LLOYD [MAINWARING]⁷³⁸ on 27 September, in Michaelchurch.
- 1843**
Birth of Thomas GRIFFITHS⁶⁹¹ on 17 August.
- 1844**
Birth of Hugh LLOYD⁶⁷³.
- 1845**
Birth of Lloyd DAVIES⁶⁸⁸.
- 1846**
Birth of John LLOYD⁶⁷⁵.
Marriage of Hugh LLOYD⁷⁴⁹ and Elizabeth LLOYD [LEWIS]⁷⁵⁰ in Presteigne.
Birth of John LLOYD⁷¹⁰ on 10 November, in Newchurch.
- 1847**
Birth of Sarah Ann LLOYD⁶⁹³ in Old Radnor.
Birth of Elizabeth (Bessie) JAMES [LLOYD]⁶⁷⁷.
Birth of James DAVIES⁶⁸⁹.
- 1848**
Death of Elizabeth LLOYD [LEWIS]⁷⁵⁰ in April.
Birth of Hugh LLOYD⁷⁰⁹ on 30 April.
Marriage of James EVANS⁷⁵³ and Sarah EVANS [LLOYD]⁷⁵² on 1 June, in Michaelchurch.
Birth of James EVANS⁷²⁵.
- 1849**
Birth of Sarah LLOYD [MILWARD]⁶⁸⁰ in Llanfihangell.
Birth of Jeffrey Thomas LLOYD⁶⁹⁴ in Old Radnor.
Death of Hugh LLOYD⁷⁰⁹.
- 1850**
Birth of William LLOYD⁶⁷⁹ in Cwmshenkin, Glascwm.
Birth of John EVANS⁷²⁶.
Birth of Edward DAVIES⁶⁹⁰.
Birth of Thomas LLOYD⁷¹¹ on 31 August, in Bryngwyn.
- 1851**
Birth of William MORGAN⁶⁸⁴ in Clifford, Hereford.
- 1852**
Christening of Evan LLOYD⁶⁸¹ on 22 March, in Glascwm.
Death of James EVANS⁷²⁵.
Death of Sarah Ann EVANS⁷²⁷ in (2 Weeks).
Birth of Catherine LLOYD [POWELL]⁷¹⁴ in Glanant.
Birth of Sarah Ann EVANS⁷²⁷.
Birth of Evan LLOYD⁶⁸¹ in Cwmshenkin, Glascwm.
Death of John EVANS⁷²⁶.
- 1853**
Birth of Edward Lewis LLOYD⁷¹³ in Bryngwyn.
- 1854**
Birth of Richard LLOYD⁶⁹⁵ in Michaelchurch.
- 1855**
Birth of John EVANS⁷²⁸ in Blaenpeak, Brilly Mountain, UK.

1855 (Continued)

Marriage of William LLOYD⁷⁴⁷ and Jane LLOYD [GRIFFITHS]⁷⁴⁸ in Kington.
 Birth of William LLOYD⁷⁰⁰ in Huntington, UK.
 Death of Ann LLOYD [DEAKINS (DAKIN)]⁷⁵⁶ on 11 August, in Baynham Hall.

1856

Death of Hugh LLOYD⁷⁵⁵ on 9 March, in Baynham Hall.
 Birth of John LLOYD⁷⁰¹ in Michaelchurch.

1857

Birth of James LLOYD⁷⁰³ in Huntington, UK.
 Birth of Sarah Sophia MORGAN [LLOYD]⁶⁸³ in Glascwm.
 Birth of Mary Ann (Polly) FRANCIS [LLOYD]⁶⁹⁶ in Brilley.

1858

Birth of Hugh LLOYD⁷⁰⁵ in Michaelchurch.
 Birth of Edward Baker PHILLIPS⁶⁹⁹ in Presteigne.
 Birth of Hugh Lloyd EVANS⁷²⁹ in Blaenpeak, Brilly Mountain, UK.
 Birth of Sarah Ann LLOYD [HARVARD]⁷¹² in Nartyd.
 Marriage of Samuel MEREDITH⁶⁶⁹ and Ann MEREDITH [LLOYD]⁶⁶⁸ on 9 October, in Glascwm.

1859

Birth of Harriett LLOYD [DREW]⁷⁰⁴ in Cefnlllys, Radnorshire, Wales.

1860

Birth of Thomas LLOYD⁷⁰⁷ in Michaelchurch.
 Marriage of Hugh LLOYD⁷⁴⁹ and Sarah LLOYD [EVANS]⁷⁵¹ in Hay.

1861

Death of John LLOYD⁶⁶⁷ on 14 February.
 Birth of Clara LLOYD [HILL]⁶⁸² in Brilley.
 Birth of Mary LLOYD⁷¹⁵ in Hay.
 Birth of Charles LLOYD⁷⁰⁸ in Michaelchurch.
 Birth of Thomas EVANS⁷³⁰ in Blaenpeak, Brilly Mountain, UK.
 Birth of Benjamin LLOYD⁵⁵² in Old Radnor.
 Birth of Elizabeth Ann (Eliza) LLOYD [MEREDITH]⁵⁵¹ in Glascwm.

1862

Death of Ann LLOYD [MAINWARING]⁷³⁸ on 4 March.
 Birth of Fortune GRIFFITHS [DAVIES]⁶⁹² in Cefnlllys, Radnorshire, Wales.

1863

Birth of Annie PHILLIPS [LLOYD]⁶⁹⁸ in Michaelchurch.
 Birth of William EVANS⁷³¹ in Blaenpeak, Brilly Mountain, UK.

1864

Birth of Martha LLOYD [POWELL]⁶⁷⁴.

1865

Birth of Samuel MEREDITH⁵⁵³ in Glascwm.
 Birth of Sarah Ann PARRY [EVANS]⁷³² in Blaenpeak, Brilly Mountain, UK.
 Birth of Hugh Caleb LLOYD⁵⁵⁷.
 Birth of William LLOYD⁷¹⁶.

1866

Marriage of Thomas LLOYD⁶⁷⁰ and Margaret LLOYD [CONNOP]⁶⁷¹ in Presteigne.
 Birth of Margaret LLOYD [REES]⁷⁰⁶ in Cefnlllys, Radnorshire, Wales.
 Birth of Edmund Danzey DREW⁵⁶⁰ in Llanwrthwl, Brecknock, Wales.
 Birth of James Thomas (Tom) LLOYD⁵⁵⁸ in Eardisley, Hereford, England.
 Birth of Thomas FRANCIS⁶⁹⁷ in Knighton.
 Birth of Rachel LLOYD [REES]⁷⁰² in Presteigne.

1867

Death of John LLOYD⁷¹⁰ on 24 June.
 Birth of Emma Eliza LLOYD [BOND]⁷¹⁸.
 Birth of Evan LLOYD⁷¹⁷.

1868

Birth of Margaret DREW [LLOYD]⁵⁵⁹ in Glascwm.
 Birth of Thomas MEREDITH⁵⁵⁴ in Glascwm.

1869

Death of Richard LLOYD⁷⁴⁵ on 22 June.
 Marriage of William LLOYD⁶⁷⁹ and Sarah LLOYD [MILWARD]⁶⁸⁰ in Pentwyn, Gladestry.
 Birth of Alice LLOYD⁷¹⁹.

1870

Death of John LLOYD⁷³⁷ on 29 June, in Michaelchurch.
 Birth of Elizabeth DAVIES [LLOYD]⁵⁶¹ in Glascwm.

1870 (Continued)

Birth of Marianne EVANS⁷³⁴ in Blaenpeak, Brilly Mountain, UK.
 Birth of Adeliza Ann LLOYD⁵⁸³ on 22 July, in Llanfihangell.
 Christening of Adeliza Ann LLOYD⁵⁸³ on 4 August.

1871

Birth of Annie GOODWIN [MEREDITH]⁵⁵⁵ in Glascwm.
 Marriage of James JAMES⁶⁷⁸ and Elizabeth (Bessie) JAMES [LLOYD]⁶⁷⁷ in Kington.
 Birth of Price John LLOYD⁷²⁰.
 Birth of William Bayley LLOYD⁵⁸⁴ on 16 October, in Llanfihangell.

1872

Birth of Elizabeth Ann (Lizzie) DAVIES [JAMES]⁵⁸¹.
 Birth of Mary Ann (Polly) WILLIAMS [LLOYD]⁵⁶³ in Glascwm.
 Birth of William Owen ROBERTS⁵⁶⁹.
 Birth of Richard BYWATER⁵⁶⁷.
 Birth of Sophia Matilda (Tillie) EVES [LLOYD]⁵⁸⁵ on 29 November, in Llanfihangell.

1873

Birth of Sarah Ann LLOYD⁷²¹.

1874

Birth of Arthur LLOYD⁷²² in Bryngwyn.
 Marriage of John LLOYD⁶⁷⁵ and Mary Ann LLOYD [DAVIES]⁶⁷⁶ on 24 November, in Michaelchurch.

1875

Birth of David Thomas MEREDITH⁷²⁴ in Llanchanges.

1876

Birth of Elizabeth Anne (Annie) LANE [LLOYD]⁵⁸⁷ on 14 May, in Gladestry.
 Birth of John Evan LLOYD⁵⁶⁵ in Glascwm.
 Marriage of Thomas LLOYD⁷¹¹ and Sarah Ann LLOYD [HARVARD]⁷¹² in Crickhowell.
 Birth of Elizabeth MEREDITH [LLOYD]⁷²³ in Llanstephen.

1877

Birth of Sarah Rosa BYWATER [LLOYD]⁵⁶⁶ in Glascwm.
 Birth of Matthew John LLOYD⁶⁵³ in Llanvelliion.
 Birth of John BYWATER⁵⁷¹.

1878

Birth of Alice LLOYD⁵⁸⁹ on 2 May, in Gladestry.
 Marriage of William MORGAN⁶⁸⁴ and Sarah Sophia MORGAN [LLOYD]⁶⁸³ in Kington.
 Birth of Sarah Ann PITT [LLOYD]⁶⁵⁴ in Llanvelliion.

1879

Death of John LLOYD⁶⁷⁵ on 27 May, in Llanpica.
 Death of Sophia LLOYD⁷⁴⁰ on 30 May.
 Burial of John LLOYD⁶⁷⁵ on 31 May, in Michaelchurch.
 Marriage of Edward Lewis LLOYD⁷¹³ and Catherine LLOYD [POWELL]⁷¹⁴ in Crickhowell.
 Birth of Sarah Anne MORGAN⁶⁰⁶ in Bryngwyn, Radnorshire, UK.

1880

Death of Thomas LLOYD⁷³⁹ on 19 February, in Empton Farm, UK.
 Birth of Ann Sophia ROBERTS [LLOYD]⁵⁶⁸ in Glascwm.
 Birth of Mary Elizabeth WILLIAMS [MORGAN]⁶⁰⁷ in Bryngwyn, Radnorshire, UK.
 Birth of Charles LLOYD⁵⁹⁰ in Gladestry.

1881

Marriage of James LLOYD⁷⁰³ and Harriett LLOYD [DREW]⁷⁰⁴ in Kington.
 Birth of Thomas Hugh LLOYD⁶⁵⁶ in Crickhowell.
 Birth of Sarah Jane (Janey) JAMES [LLOYD]⁶²⁷.
 Birth of Gladys LLOYD⁵⁹¹ on 2 September.

1882

Death of John GRIFFITHS⁷⁴⁴ on 18 June.

1883

Birth of Emily Elizabeth LLOYD [WILLOUGHBY]⁵⁷⁵ in Llandrindod Wells.
 Birth of William Thomas MORGAN⁶⁰⁹ in Bryngwyn, Radnorshire, UK.
 Birth of Ada Agnes BYWATER [LLOYD]⁵⁷⁰ in Glascwm.
 Birth of Margaret Jane LLOYD [PRITCHARD]⁶³².
 Birth of William LLOYD⁶²⁹.
 Birth of Hugh LLOYD⁵⁹² in October, in Huntington, UK.

1884

Birth of Thomas LLOYD⁶³¹.
 Death of Thomas LLOYD⁷⁰⁷ on 3 September.

1885

Death of Jane LLOYD [GRIFFITHS]⁷⁴⁸ on 23 May.

1885 (Continued)

Death of William LLOYD⁷⁴⁷ on 11 June.
 Birth of Evan John Lloyd MORGAN⁶¹⁰ in Clyro, Radnorshire, UK.
 Marriage of Hugh LLOYD⁶⁷³ and Martha LLOYD [POWELL]⁶⁷⁴ in Wrexham, Denbighshire.
 Birth of Thomas John LLOYD⁵⁹⁴ on 8 November.

1886

Death of Ann DAVIES [LLOYD]⁷⁴¹ on 28 February.

1887

Birth of Evan Sidney LLOYD⁵⁹⁶ on 8 April.
 Birth of John LLOYD⁶³³.
 Marriage of Edward Baker PHILLIPS⁶⁹⁹ and Annie PHILLIPS [LLOYD]⁶⁹⁸ in Kington.
 Death of John LLOYD⁶³³ on 30 August, in (6 Months).
 Birth of Evan Thomas LLOYD FRSM, MBMA, MRSI⁶⁰¹ on 31 October, in Empton Farm, UK.

1888

Marriage of Hugh LLOYD⁷⁰⁵ and Margaret LLOYD [REES]⁷⁰⁶ on 29 March, in Kington Baptist Chapel (By Licence).
 Birth of Minnie Gladys LLOYD⁵⁷² in Glascwm.
 Birth of Margaret Jane MORGAN [LLOYD]⁶⁴³.
 Birth of Hugh LLOYD⁵⁷³.

1889

Birth of John LLOYD⁶³⁴.
 Birth of Emily LLOYD⁶⁶⁰ in Crickhowell.
 Birth of Eva May LLOYD [CLARKE]⁶⁵⁷.
 Birth of Beatrice Eva LLOYD [LEWIS]⁶⁵⁸ in Crickhowell.
 Birth of Sarah Ann LLOYD [HAMER]⁶³⁶.

1890

Birth of Annie Sophia (aka Nancy) LLOYD⁵⁷⁷ on 25 February.
 Death of Hugh LLOYD⁶⁷³ on 26 June.
 Birth of Elizabeth Florence LLOYD⁶⁰².
 Death of Martha LLOYD [POWELL]⁶⁷⁴ on 3 July.
 Birth of Arthur STRATTON⁵⁹⁹ on 9 July.
 Birth of Sarah Janet STRATTON [LLOYD]⁵⁹⁸ on 18 July.

1891

Birth of Hugh LLOYD⁶⁴⁵ on 30 March.
 Birth of James LLOYD⁶³⁵.
 Birth of Florence LLOYD [HARLEY]⁵⁷⁴.
 Birth of Blanche PEVERILL⁶¹⁶ in Yeovil.
 Birth of Edward G MORGAN⁶¹¹ in Clyro, Radnorshire, UK.

1892

Marriage of Evan LLOYD⁷¹⁷ and Emma Eliza LLOYD [BOND]⁷¹⁸ in Hay.

1893

Birth of Mabel LLOYD [KINGS]⁵⁹⁷ on 26 January.
 Birth of James H MORGAN⁶¹² in Clyro, Radnorshire, UK.
 Birth of William LLOYD⁶⁴⁷.
 Birth of Charles LLOYD⁶³⁷.
 Death of Sarah Sophia MORGAN [LLOYD]⁶⁸³ in Hay, Brecknockshire.
 Birth of Edith LLOYD⁶⁰⁰ in October.
 Death of Charles LLOYD⁵⁹⁰ on 10 November.

1894

Death of Edith LLOYD⁶⁰⁰ on 26 March.
 Death of Ann MEREDITH [LLOYD]⁶⁶⁸.
 Birth of Lily May (aka Doris) LLOYD [EVANS]⁶³⁸ in Ledbury.

1895

Birth of David PUGH⁶¹⁴ in Hay, Brecknockshire.

1896

Birth of Catherine (Kitty) LLOYD⁶⁴⁸.
 Birth of Hugh LLOYD⁶³⁹ in Gladestry.
 Birth of Susannah LLOYD [GODWIN]⁶⁴⁶.
 Marriage of Edmund Danzey DREW⁵⁶⁰ and Margaret DREW [LLOYD]⁵⁵⁹ in Knighton.
 Birth of Sarah Maude LLOYD [OWEN]⁵⁷⁶.
 Birth of Annie Clara LLOYD⁶⁰³.

1897

Birth of Ira MORRIS RAF⁴⁰⁸.
 Birth of Laura LLOYD [KINGS]⁵⁹³ on 13 September.

1898

Birth of Lillian LLOYD⁶⁶¹ in Hay.

1899

Birth of William Henry LLOYD⁶²⁰ on 2 April, in Michaelchurch.
 Marriage of William WILLIAMS⁵⁶⁴ and Mary Ann (Polly) WILLIAMS [LLOYD]⁵⁶³ in Knighton.
 Birth of John (Jack ?) LLOYD⁶⁴⁹.
 Marriage of Richard BYWATER⁵⁶⁷ and Sarah Rosa BYWATER [LLOYD]⁵⁶⁶ in Knighton.
 Marriage of John LLOYD⁷⁰¹ and Rachel LLOYD [REES]⁷⁰² in Kington.
 Birth of Danzey Evan LLOYD⁶⁴¹.

1900

Birth of Gwendoline Gertrude WHITTALL [LLOYD]⁶²¹ on 30 March.
 Death of Mary GRIFFITHS [LLOYD]⁷⁴³ on 13 June.
 Birth of William Baden POWELL⁶²⁶.
 Marriage of David Thomas MEREDITH⁷²⁴ and Elizabeth MEREDITH [LLOYD]⁷²³ in Hay.
 Birth of Alfred Cornelius PASSANT⁵⁷⁹ in Forden, Montgomeryshire.
 Death of Thomas LLOYD⁶⁷⁰ on 1 August.

1901

Birth of James LLOYD⁶⁵¹.
 Birth of Gertrude LLOYD [JONES]⁶⁴².
 Birth of Mary WILLIAMS³⁹⁷.
 Birth of Ada Marion GITTOES [LLOYD]⁶⁰⁴.
 Marriage of William Jones PARRY⁷³³ and Sarah Ann PARRY [EVANS]⁷³² in Hay, Brecknockshire.
 Marriage of Thomas GRIFFITHS⁶⁹¹ and Fortune GRIFFITHS [DAVIES]⁶⁹² in Strand, London.
 Marriage of Ernest Edward EVES⁵⁸⁶ and Sophia Matilda (Tillie) EVES [LLOYD]⁵⁸⁵ in Docking, Norfolk.
 Marriage of William Owen ROBERTS⁵⁶⁹ and Ann Sophia ROBERTS [LLOYD]⁵⁶⁸ in Knighton.
 Birth of Jane Sophia POWELL [LLOYD]⁶²³.
 Birth of William LLOYD⁶⁶² in Hay.
 Birth of Eva PUGH [GRIFFITHS]⁶¹³ in Bryngwyn, Radnorshire, UK.

1902

Birth of Annie Matilda (Nan) PRITCHETT [EVES]⁴³⁷ on 17 March.
 Birth of Eleanor Edith MEREDITH⁶⁶⁴.
 Birth of Caleb James BYWATER⁴⁰².
 Birth of Thomas Clement J GRIFFITHS⁶¹⁵.
 Birth of Rosa Mary BYWATER⁴⁰¹ in Knighton.
 Death of James EVANS⁷⁵³ on 8 September.

1903

Birth of Arthur GRIFFITHS⁶¹⁷.
 Birth of William Thomas ROBERTS⁴¹⁷.
 Birth of Adah Margaret BYWATER⁴⁰⁴ in Knighton.

1904

Birth of Edith Mary POWELL [LLOYD]⁶²⁵.
 Birth of Gladys Anne ROBERTS⁴¹⁹.
 Birth of Hilda Elizabeth MEREDITH⁶⁶⁵.
 Birth of John (aka Jack) BYWATER⁴⁰⁵ in Ludlow, Shropshire.
 Birth of Aubrey PRITCHETT⁴³⁸ on 20 August.

1905

Death of Samuel MEREDITH⁶⁶⁹ on 28 May.
 Birth of Dorothy Clare LLOYD [DAVIES]⁵¹⁶.

1906

Marriage of Harry Arthur PITT^{?655} and Sarah Ann PITT [LLOYD]⁶⁵⁴ in Hay on Wye.
 Birth of James Albert ROBERTS⁴²⁰ in Knighton.

1907

Birth of Edmund DREW³⁹¹.
 Birth of Naomi MORRIS [BYWATER]⁴⁰⁷.
 Birth of Herbert LLOYD⁶⁶³ in Hay.
 Marriage of William Edward DAVIES⁵⁶² and Elizabeth DAVIES [LLOYD]⁵⁶¹ in Knighton.

1908

Death of Margaret LLOYD [CONNOP]⁶⁷¹ on 26 May.
 Birth of Winifred Sarah MEREDITH⁶⁶⁶ in Glamorgan.

1910

Birth of Herbert Arthur LLOYD - STEPHENS⁴³⁴ on 25 February, in The Green, Walton, Old Radnor.
 Marriage of Thomas LLOYD⁶³¹ and Margaret Jane LLOYD [PRITCHARD]⁶³² in Kington.
 Birth of Robert David BYWATER⁴¹¹.
 Birth of William Caleb ROBERTS⁴²².
 Birth of Alma LLOYD - STEPHENS [SYMES]⁴³⁵ in Pontypridd.
 Marriage of Henry (Harold) JAMES⁶²⁸ and Sarah Jane (Janey) JAMES [LLOYD]⁶²⁷ in Kington.

1910 (Continued)

Birth of Phyllis WILLIAMS [JAMES]⁵⁰⁶.

1911

Birth of Murial Gladys LLOYD⁴³⁶ on 6 November.

1912

Death of Mary LLOYD⁶⁷² on 26 March, in Blaenbeddew.

Birth of Edward HARRIS⁴¹⁴.

Birth of Vincent LLOYD⁵¹⁴.

Marriage of Thomas Hugh LLOYD⁶⁵⁶ and Eva May LLOYD [CLARKE]⁶⁵⁷ in Crickhowell.

Death of Evan LLOYD⁶⁸¹ on 19 December.

1913

Birth of Muriel Annie (Dolly) LLOYD⁴²⁴.

Birth of Walter LLOYD⁵¹⁵.

1914

Birth of Joyce Sarah HARRIS [BYWATER]⁴¹³ on 20 March.

Marriage of Thomas LANE⁵⁸⁸ and Elizabeth Anne (Annie) LANE [LLOYD]⁵⁸⁷ in Cheltenham.

Birth of Mildred LLOYD⁵⁴⁶ in Crickhowell.

Birth of Gwendoline Dilys PICKERSGILL [LLOYD]⁴²⁵.

Birth of Jack SINCLAIR⁴⁴⁶ on 14 September.

Death of Sarah EVANS [LLOYD]⁷⁵² on 22 October.

1915

Birth of Mary JAMES⁵⁰⁸.

Death of Elizabeth (Bessie) JAMES [LLOYD]⁶⁷⁷.

1916

Marriage of Charles LLOYD⁶³⁷ and Lily May (aka Doris) LLOYD [EVANS]⁶³⁸ in Kington.

Birth of Rosa J LLOYD⁵⁴⁷ in Crickhowell.

Birth of Tom Evan LANE⁴³⁹.

Marriage of James LLOYD⁶³⁵ and Sarah Ann LLOYD [HAMER]⁶³⁶ in Kington.

Marriage of Thomas John LLOYD⁵⁹⁴ and Catherine LLOYD [JONES]⁵⁹⁵ in Swansea.

Birth of Constance Minnie DAVIES [BYWATER]⁴¹⁵ on 12 July, in Leominster, UK.

1917

Birth of Hannah Heslop STRATTON [MACAULAY]⁴⁵⁸ on 6 April.

Birth of John (Jack) E DUGGAN⁵²⁰ in Kington.

Birth of Kathleen Florence Martha TAIT [LLOYD]⁴²⁷.

Birth of Ethel Elizabeth LLOYD⁵²⁷ in Knighton.

Birth of Robert Owen ROBERTS⁴⁶⁰ on 20 December.

1918

Birth of Hugh LLOYD⁵³⁸ on 16 May.

Death of Florence LLOYD [HARLEY]⁵⁷⁴.

Birth of Charles G LLOYD⁵²⁸ in Knighton.

Marriage of Arthur STRATTON⁵⁹⁹ and Sarah Janet STRATTON [LLOYD]⁵⁹⁸ in West Bromwich.

Birth of Margaret Maisie HARRIS [LLOYD]⁴²⁹.

1919

Death of Eva May LLOYD [CLARKE]⁶⁵⁷ in Knighton.

1920

Birth of John Arthur STRATTON⁴⁵⁷ on 7 January.

Birth of Graham Hugh LLOYD⁵³³.

1921

Birth of Edith Megan ROBERTS [STRATTON]⁴⁵⁹ on 5 January.

Marriage of Hugh LLOYD⁵⁹² and Laura LLOYD [KINGS]⁵⁹³ on 29 March, in Catshill, Worcestershire.

Birth of Edward (Ted) A LLOYD⁵²⁹ in Knighton.

Birth of Irene LANE [BALLINGER]⁴⁴⁰.

Birth of Mercia Willoughby DAVIES [LLOYD]⁴³¹.

Birth of Margeurite J MORGAN [JAMES]⁵¹² in Kington.

Birth of Evan Rice LLOYD⁵²¹ on 30 July.

Birth of Laurence Walter Hugh LLOYD RAFVR⁴⁴¹ on 26 December.

1922

Marriage of Thomas Hugh LLOYD⁶⁵⁶ and Beatrice Eva LLOYD [LEWIS]⁶⁵⁸ in Crickhowell.

Birth of Arther E LLOYD⁵⁴⁸ in Crickhowell.

Death of Harriett LLOYD [DREW]⁷⁰⁴ on 18 August.

1923

Birth of Henry Charles LLOYD⁵²³.

Birth of Hugh John Willoughby LLOYD⁴³³.

Death of Hugh John Willoughby LLOYD⁴³³.

1923 (Continued)

Death of William LLOYD⁶⁷⁹ on 7 August, in Kington.

1924

Birth of Doreen Gladys LLOYD⁴⁴² on 25 April.

Death of Thomas GRIFFITHS⁶⁹¹ on 26 May.

Birth of Donald BURCHILL²⁷³.

Birth of Kathleen Mary POWELL⁴⁸².

Birth of Hilde LLOYD⁵³⁰ in Knighton.

Birth of Hilda E LLOYD⁵⁴⁹ in Crickhowell.

Death of Kathleen Mary POWELL⁴⁸².

Birth of Hilda LLOYD⁵²² on 2 July.

Birth of Doris PHILLIPS [LLOYD]⁵⁴⁰ in September.

1925

Birth of Eva Grace LLOYD [MORRIS]⁵³⁹ on 12 April, in Clehonger.

Birth of Dorothy May JONES [POWELL]⁴⁸³.

1926

Marriage of Evan Sidney LLOYD⁵⁹⁶ and Mabel LLOYD [KINGS]⁵⁹⁷ on 25 May, in Catshill, Worcestershire.

Birth of John LLOYD⁴⁴³ on 12 June, in Fownhope, Herefordshire.

Birth of Roland LLOYD⁵³⁴ in Kington.

Birth of Gwendoline Jane (Babs) INGRAM [POWELL]⁴⁸⁵.

Birth of Edith A LLOYD⁵⁵⁰ in Crickhowell.

Birth of Mona LLOYD⁵³⁵.

Marriage of John BYWATER⁵⁷¹ and Ada Agnes BYWATER [LLOYD]⁵⁷⁰ in Lea Hall.

1927

Birth of Raymond George (Bill) BOWS BA⁴⁴⁸ on 17 June, in Lincoln.

Death of Gladys Anne ROBERTS⁴¹⁹.

Marriage of Thomas Clement J GRIFFITHS⁶¹⁵ and Blanche PEVERILL⁶¹⁶ in Brecknock, UK.

1928

Birth of Laura Marjorie SINCLAIR [LLOYD]⁴⁴⁵ on 27 June.

Birth of Lesley M BASTIN [GRIFFITHS]⁴⁷⁰ in Hay, Brecknockshire.

Marriage of Aubrey PRITCHETT⁴³⁸ and Annie Matilda (Nan) PRITCHETT [EVES]⁴³⁷ in Dursley, Gloucestershire.

Birth of Thomas John POWELL⁴⁸⁷.

Marriage of David PUGH⁶¹⁴ and Eva PUGH [GRIFFITHS]⁶¹³ in Hay, Brecknockshire.

Birth of Sidney Walter Gordon LLOYD⁴⁵⁴ on 1 September, in Cardiff.

1929

Death of Rachel LLOYD [REES]⁷⁰² on 6 April.

Birth of Edward (Eddie) PUGH⁴⁶¹ in Hay, Brecknockshire.

Death of Sarah Rosa BYWATER [LLOYD]⁵⁶⁶.

Birth of Peter GRIFFITHS⁴⁷² in Hay, Brecknockshire.

1930

Birth of Peggy LLOYD [SIMMONS]⁴⁵⁵ on 25 February, in Charlton Kings.

Death of Thomas LLOYD⁷¹¹.

Birth of Herbert Oliver FARMER³⁵⁶.

Birth of Alice May (Diddy) LLOYD⁵³⁶.

Birth of Dorothy Mary LLOYD⁵³¹ in Knighton.

Marriage of James Albert ROBERTS⁴²⁰ and Annie ROBERTS [WILLIAMS]⁴²¹ in Knighton.

Death of James LLOYD⁷⁰³ on 9 December.

1931

Death of William LLOYD⁷⁰⁰ on 1 April.

Birth of Annie Mabel (Nancy) BOWS [LLOYD] BA⁴⁴⁷ on 16 April, in Westbury on Severn.

Marriage of William Baden POWELL⁶²⁶ and Edith Mary POWELL [LLOYD]⁶²⁵ in Kington.

Marriage of John (aka Jack) BYWATER⁴⁰⁵ and Edith BYWATER [DAVIES]⁴⁰⁶.

Birth of Elizabeth Nancy LEWIS [LLOYD]⁵⁴².

Birth of Elizabeth Rachel PRICE [POWELL]⁴⁸⁹.

Birth of Marjorie Sally SMITHERS [GRIFFITHS]⁴⁷³ in Hay, Brecknockshire.

Birth of Brian A S FISHER²²⁰ in Ross, Herefordshire.

Death of Emily Elizabeth LLOYD [WILLOUGHBY]⁵⁷⁵.

Birth of Joyce Margaret DAVIES [PUGH]⁴⁶² in Hay, Brecknockshire.

Birth of Beryl Kathryn LLOYD [MILLER]⁴⁴⁴ on 17 August, in Earls Barton.

1932

Death of John LLOYD⁶³⁴ on 3 March.

Birth of Lena Mary POWELL⁴⁹⁵ in Kington.

Birth of Dilys LLOYD⁴⁵⁶ in Cardiff.

Birth of Pamela M GRIFFITHS [GRIFFITHS]⁴⁷⁵ in Hay, Brecknockshire.

1932 (Continued)

- Death of Sarah LLOYD [MILWARD]⁶⁸⁰ in Blaenpeak, Brilly Mountain, UK.
 Birth of Donald George KNIGHTON Reverend³¹⁷.
 Death of Elizabeth Ann (Lizzie) DAVIES [JAMES]⁵⁸¹ on 4 October, in Llandrindod Wells.
 Birth of Rita Hazel FARMER [JAMES]³⁵⁵ on 8 November, in Kington.

1933

- Birth of Kenneth Charles POWELL⁴⁹¹.
 Death of Ann Sophia ROBERTS [LLOYD]⁵⁶⁸.
 Birth of Jeanette BOWEN [POWELL]⁴⁹⁷.
 Death of John LLOYD⁷⁰¹ on 23 November.

1934

- Birth of Derek BROWN²⁷².
 Birth of William Owen POWELL⁴⁹⁹.
 Birth of Marian Jane LLOYD⁵³² in Knighton.
 Birth of David Kingsley LLOYD⁴⁴⁹ on 3 July.
 Death of Edmund Danzey DREW⁵⁶⁰ on 9 July.
 Birth of Trevor Glyn DAVIES⁴¹⁶ on 11 December.
 Death of James Thomas (Tom) LLOYD⁵⁵⁸ on 17 December.

1935

- Birth of Joan S BYWATER [MARTIN]²¹⁸ on 15 February.
 Birth of Richard David BYWATER²¹⁷ in Ludlow, Shropshire.
 Marriage of William Thomas ROBERTS⁴¹⁷ and Doris ROBERTS [MASON]⁴¹⁸ in Radnorshire East, UK.
 Birth of Edith Margaret DAVIES [POWELL]⁴⁹³.
 Marriage of Herbert Arthur LLOYD - STEPHENS⁴³⁴ and Alma LLOYD - STEPHENS [SYMES]⁴³⁵ in Pontypridd.
 Marriage of Sid WILLIAMS⁵⁰⁷ and Phyllis WILLIAMS [JAMES]⁵⁰⁶.

1936

- Birth of David EARTHROWL³¹⁴ on 25 February.
 Birth of Ruth JAMES [BYWATER]²²⁸.
 Marriage of Alfred Cornelius PASSANT⁵⁷⁹ and Annie Sophia (aka Nancy) LLOYD⁵⁷⁷.
 Birth of Darinda M FISHER [BYWATER]²¹⁹ in Ludlow, Shropshire.

1937

- Birth of Christine Megan LLOYD⁴⁵¹ on 26 March.
 Birth of James DAVIES²⁸⁰.
 Death of Ada Agnes BYWATER [LLOYD]⁵⁷⁰.
 Birth of Muriel Doreen LLOYD²⁷¹.
 Death of Hugh LLOYD⁷⁰⁵ on 26 August.
 Death of Fortune GRIFFITHS [DAVIES]⁶⁹² on 16 December, in Bryngwyn, Radnorshire, UK.
 Marriage of Edward HARRIS⁴¹⁴ and Joyce Sarah HARRIS [BYWATER]⁴¹³ in the 2nd quarter of 1937, in Leominster, UK.

1938

- Birth of Meic STEPHENS MA Dlott²⁸¹ in Treforest.
 Birth of Robert Lloyd POWELL⁵⁰¹.
 Birth of Margaret LEWIS [BYWATER]²²¹ in Ludlow, Shropshire.
 Death of Mary Elizabeth BYWATER [THOMAS]³⁹⁹ in - 1939.
 Birth of Ruth Wynn STEPHENS [MEREDITH]²⁸².
 Death of Adeliza Ann LLOYD⁵⁸³ on 28 December.

1939

- Death of Charles LLOYD⁷⁰⁸ on 28 May.
 Death of Clara LLOYD [HILL]⁶⁸².

1940

- Death of Arthur STRATTON⁵⁹⁹ on 12 April.
 Birth of Ms. ILES [POWELL]⁵⁰³.
 Marriage of Thomas A MORGAN⁵¹³ and Margeurite J MORGAN [JAMES]⁵¹² in Kington.
 Birth of Margaret Patricia Ismay STEPHENS [MORRIS]²⁸⁴.
 Birth of Murray Lloyd BYWATER²⁴¹ in about 1940.

1941

- Birth of Austin Thomas James MORGAN³⁵⁹ on 3 March.
 Death of Evan Sidney LLOYD⁵⁹⁶ on 31 March, in Cardiff.
 Death of Laurence Walter Hugh LLOYD RAFVR⁴⁴¹ on 20 April, in Canada.
 Birth of Robin BYWATER BVMS, PhD²³⁰ on 16 June.

1942

- Birth of Pamela LEWIS [GRIFFITHS]⁴⁷⁷.
 Marriage of Ira MORRIS RAF⁴⁰⁸ and Naomi MORRIS [BYWATER]⁴⁰⁷.
 Birth of Peggy LLOYD³⁶².
 Birth of Kathleen M HARRIS [JONES]²⁵⁶.

1942 (Continued)

Birth of Vivien MORRIS [EVANS]²⁴⁰.

1943

Birth of Lloyd STEPHENS²⁸³.

Birth of John BYWATER²³⁴.

Birth of Richard Lloyd BYWATER²⁴⁵.

Birth of John BYWATER²⁴⁸.

Marriage of William Caleb ROBERTS⁴²² and Mona A ROBERTS [PLAIN]⁴²³ in Radnorshire East, UK.

Death of William Bayley LLOYD⁵⁸⁴ on 19 December.

1944

Death of Graham Hugh LLOYD⁵³³ on 7 January.

Death of Muriel Annie (Dolly) LLOYD⁴²⁴.

Birth of Richard MORRIS²³⁹.

Birth of Carmen LLOYD³⁶³.

Birth of Thomas L HARRIS²⁵⁵.

Marriage of John Arthur STRATTON⁴⁵⁷ and Hannah Heslop STRATTON [MACAULAY]⁴⁵⁸ in Wandsworth.

1945

Birth of Phyllis Anne BYWATER²²³ in Ludlow, Shropshire.

Death of John BYWATER⁵⁷¹.

Birth of Glyn WILLIAMS³⁵³.

1946

Birth of Andrew William ROBERTS¹⁰⁶.

Birth of John Thomas BYWATER²²⁴ in Ludlow, Shropshire.

Birth of Geoffrey BYWATER²⁵⁰.

Birth of Rosemary THOMAS [BYWATER]²³⁶.

Birth of Andrew William ROBERTS¹⁰⁷.

Birth of Christine Elizabeth MENHENNICK [STRATTON]³¹¹ on 30 October.

1947

Death of Thomas LLOYD⁶³¹.

Birth of Roger BYWATER²⁵¹.

Birth of Roger John NEWTON³⁶⁷ on 21 December.

1948

Death of Margaret DREW [LLOYD]⁵⁵⁹ on 7 May.

Death of John Evan LLOYD⁵⁶⁵.

Birth of Daphne BYWATER²²⁵ in Ludlow, Shropshire.

Death of Alice LLOYD⁵⁸⁹ on 29 September.

Birth of Bronwen Dorothy STRATTON³¹³ on 29 September.

Birth of Alan Hugh LLOYD³⁷⁷ on 29 November, in Quebb Farm, Eardisley.

1949

Birth of Richard BYWATER²³⁸.

Marriage of Hugh LLOYD⁵⁷³ and Sarah Maude LLOYD [OWEN]⁵⁷⁶.

1950

Birth of Philip LANE²⁸⁷ on 7 May.

Death of Caleb James BYWATER⁴⁰².

Birth of Gwenllian KNIGHTON [ROBERTS]³¹⁶ on 18 August.

1951

Birth of Winston Barrie MORGAN³⁶⁰ on 13 February.

Marriage of Sidney Walter Gordon LLOYD⁴⁵⁴ and Peggy LLOYD [SIMMONS]⁴⁵⁵ on 24 March, in Charlton Kings Baptist Church.

Death of Margaret LLOYD [REES]⁷⁰⁶ on 4 April.

Birth of Ian PHILLIPS³⁸¹ on 15 November.

1952

Birth of Elizabeth Anne NEWTON [LLOYD]³⁶⁶ on 21 March.

Birth of Jane PHILLIPS [EDWARDS]³⁸⁴.

Birth of Elwyn John LLOYD³⁷⁹ on 30 June, in Great Quebb, Eardisley.

Birth of Sarah Marie LLOYD [GOUGH]³⁷⁸ on 2 December, in Maidenhead.

1953

Birth of Jane LLOYD [HYATT]³⁸⁰ on 11 June, in Wellington, Hereford.

Marriage of Aubrey E Michael PRITCHETT²⁸⁵ and Janet PRITCHETT [BEASLEY]²⁸⁶ in Cirencester.

Birth of Pamela PHILLIPS [SPAREY]³⁸².

Death of Hugh Caleb LLOYD⁵⁵⁷.

Marriage of John LLOYD⁴⁴³ and Beryl Kathryn LLOYD [MILLER]⁴⁴⁴ on 30 July, in Earls Barton Baptist Church.

Birth of Stephen Gareth LLOYD BSc, D.C³⁰⁶ on 23 September, in Hereford, UK.

Birth of Rachel TURNER [LANE]²⁸⁹ on 12 October.

1954

Birth of David Evan LLOYD³⁶⁸ on 18 February.
 Death of Thomas John LLOYD⁵⁹⁴.
 Marriage of Raymond George (Bill) BOWS BA⁴⁴⁸ and Annie Mabel (Nancy) BOWS [LLOYD] BA⁴⁴⁷ on 4 September.
 Birth of Colin PHILLIPS³⁸³ in November.

1955

Birth of Janet LEWIS [ROBERTS-LEWIS]³¹⁸ on 22 March.
 Death of Dorothy Clare LLOYD [DAVIES]⁵¹⁶.
 Death of Elizabeth Anne (Annie) LANE [LLOYD]⁵⁸⁷.
 Death of William Owen ROBERTS⁵⁶⁹.
 Marriage of Henry Charles LLOYD⁵²³ and Enid A LLOYD [BAKER]⁵²⁴.
 Marriage of John (Jack) E DUGGAN⁵²⁰ and Emily Maud DUGGAN [LLOYD]⁵¹⁹.

1956

Death of Sophia Matilda (Tillie) EVES [LLOYD]⁵⁸⁵ on 21 February.
 Birth of Maria Alexandra LLOYD [BUBEAR] RGN RMN²⁹² on 28 March, in Keynsham, Somerset.
 Birth of Jeanne BOWERS [BROWN]¹⁰⁸.
 Death of William Thomas ROBERTS⁴¹⁷.
 Birth of Kathryn Ann LEWIS [BOWS] BMedSci, BM, BS²⁹⁷ on 18 September, in Kensington, UK.
 Birth of Catherine LLOYD [FOLEY]³⁰⁹ on 24 October, in Hereford, UK.
 Birth of Peter Adrian LLOYD³⁰⁸ on 25 November, in Hereford, UK.

1957

Birth of Juliet LLOYD [DENMAN] Grad Dip TH³⁰⁷ on 14 March, in Warlingham, Surrey.
 Death of Sarah Ann LLOYD [HAMER]⁶³⁶ on 21 May.
 Birth of Bruce PRITCHETT¹³⁰ in Cirencester.
 Birth of Theresa Louise AWAAD [FARMER]¹⁸⁰ in Shrewsbury, UK.
 Death of Thomas FRANCIS⁶⁹⁷.
 Marriage of Brian A S FISHER²²⁰ and Darinda M FISHER [BYWATER]²¹⁹ in Ludlow, Shropshire.
 Birth of Carol BROWN¹¹⁰.

1958

Marriage of Eithel Pugh POWELL⁴⁹⁶ and Lena Mary POWELL⁴⁹⁵ in Kington.
 Marriage of John LEWIS⁵⁴³ and Elizabeth Nancy LEWIS [LLOYD]⁵⁴².
 Death of Evan Thomas LLOYD FRSM, MBMA, MRSI⁶⁰¹ on 22 December, in Empton Farm, UK.

1959

Birth of Alison LEWIS [BROWN]¹¹¹.
 Birth of John H LEWIS³⁸⁵.
 Birth of Heather Joy LLOYD³¹⁰ on 5 September, in Hereford, UK.
 Birth of David Philip John LLOYD CEng, CITP, MBCS., MAPM²⁹¹ on 9 September, in Guildford, Surrey.
 Birth of Richard BOWS RAF (Retd)²⁹⁹ on 23 September.

1960

Marriage of Gordon G LEWIS²²² and Margaret LEWIS [BYWATER]²²¹ in Ludlow, Shropshire.
 Birth of Wynn BROWN¹¹³.
 Death of Elizabeth Nancy LEWIS [LLOYD]⁵⁴².
 Birth of Jenny INGRAM³²⁶.
 Marriage of Murray Lloyd BYWATER²⁴¹ and Pamela BYWATER²⁴² in about 1960.

1961

Death of Gladys LLOYD⁵⁹¹ on 24 February.
 Death of Phyllis BYWATER [ELLIS]⁴⁰⁰ on 24 June.
 Marriage of Richard David BYWATER²¹⁷ and Joan S BYWATER [MARTIN]²¹⁸ in Ludlow, Shropshire.
 Birth of Richard Mathew BYWATER⁶⁰ in Ludlow, Shropshire.

1962

Birth of Peter Geoffrey LLOYD²⁹³ on 27 May, in Alcester, Warwickshire.
 Birth of Adrian Oliver FARMER¹⁸² in Shrewsbury, UK.
 Birth of Lynda PRICE³³⁰.
 Birth of Nigel BROWN¹¹⁵.

1963

Birth of Stehpen K LEWIS⁶⁷ in Shrewsbury, UK.
 Death of Minnie Gladys LLOYD⁵⁷².
 Birth of Rebecca BYWATER⁶² in Ludlow, Shropshire.
 Death of Richard BYWATER⁵⁶⁷ in Leominster, UK.
 Birth of Anita Jane SKYRME [POWELL]³⁷³ on 26 September.
 Death of Hugh LLOYD⁵⁹² on 21 December, in Harpole, Northamptonshire.

1964

Birth of Cheryl Esther LLOYD [DUGGAN]²⁹⁶ on 5 May, in Taunton, UK.
 Death of Sarah Jane (Janey) JAMES [LLOYD]⁶²⁷.

1964 (Continued)

Birth of Olivia STEPHENS [BYWATER]⁶³.

1965

Death of Alan JAMES⁷² in ? Road Accident.

Birth of Jane FARMER [TITLEY]¹⁸³ in Shrewsbury, UK.

Birth of Philip POWELL³²⁸.

Marriage of Meic STEPHENS MA Dlitt²⁸¹ and Ruth Wynn STEPHENS [MEREDITH]²⁸².

Marriage of Lloyd STEPHENS²⁸³ and Margaret Patricia Ismay STEPHENS [MORRIS]²⁸⁴.

Birth of Richard J LEWIS⁶⁸ in Shrewsbury, UK.

1966

Birth of Kathryn Ann WILLIAMS [POWELL]³⁷⁵ on 5 March.

Birth of Lowri Angharad EVANS [STEPHENS]¹¹⁸.

Death of Margeurite J MORGAN [JAMES]⁵¹².

Death of Elizabeth Florence LLOYD⁶⁰².

Death of Ada Marion GITTOES [LLOYD]⁶⁰⁴.

Birth of David PRICE³³¹.

Marriage of Richard MORRIS²³⁹ and Vivien MORRIS [EVANS]²⁴⁰.

Marriage of John BYWATER²⁴⁸ and Sue BYWATER [COXON]²⁴⁹.

Birth of Owen BYWATER⁷³ on 23 August.

1967

Birth of Karen Margaret LLOYD [DAWE]²⁹⁴ on 15 June, in Tavistock, Devon.

Birth of Edward PRICE³⁸⁷.

Birth of Sian CORRIE [STEPHENS]¹²⁵.

Birth of Claire DORWOOD [BROWN]¹¹⁶.

Birth of Charles Edward Lloyd BOWS MA³⁰¹ on 28 July.

Birth of Andrew Robert LLOYD RAF²⁹⁵ on 28 October, in Leicester.

1968

Birth of Margaret POWELL³³³.

Marriage of Edward HARRIS²⁵³ and Margaret HARRIS²⁵⁴.

Birth of Heledd Melangell DAY [STEPHENS]¹²⁰.

Birth of Sebastian BYWATER⁶⁵ in Ludlow, Shropshire.

Death of Hugh LLOYD⁵⁷³ in July, in Hereford, UK.

Marriage of Peter CLIFFORD²⁴⁴ and Judith Lloyd CLIFFORD [BYWATER]²⁴³ in about 1968.

Marriage of Russell PRICE²³³ and Sally PRICE [BYWATER]²³² in about 1968.

1969

Death of James LLOYD⁶³⁵ on 10 April.

Birth of Julie Anne WHATELEY¹⁰¹.

Marriage of John BYWATER²³⁴ and Kate BYWATER [JONES]²³⁵.

Death of Margaret Jane LLOYD [PRITCHARD]⁶³².

Birth of Julia MACLACHLAN [MORRIS]⁸⁰.

Birth of Brengain Gwenllian EVANS [STEPHENS]¹²².

Birth of Leslie WILLIAMS¹⁷⁴.

Birth of James ROBERTS¹⁴.

Birth of James ROBERTS¹⁵.

1970

Marriage of Jack SINCLAIR⁴⁴⁶ and Laura Marjorie SINCLAIR [LLOYD]⁴⁴⁵ in January.

Birth of Anthony Paul NEWTON¹⁸⁸ on 27 June.

Birth of Dawn WILLIAMS [PRICE]³⁸⁸.

Birth of Andrew POWELL³³⁴.

Death of John Thomas BYWATER²²⁴ in Car Accident.

1971

Death of Annie Sophia (aka Nancy) LLOYD⁵⁷⁷ on 15 April.

Birth of Michael WILLIAMS¹⁷⁶.

Death of Annie Clara LLOYD⁶⁰³.

Death of Sarah Maude LLOYD [OWEN]⁵⁷⁶.

Birth of M PRICE³³².

Birth of Phillipa Anne WHATELEY¹⁰² in Cambridge, UK.

Birth of Richard BYWATER⁷⁶ in Clun, Shropshire.

Death of John (aka Jack) BYWATER⁴⁰⁵ in Ludlow, Shropshire.

1972

Birth of Simon BYWATER⁷⁴ on 3 June.

Birth of Graham POWELL³²⁹.

Death of Jane Sophia POWELL [LLOYD]⁶²³.

Death of Ira MORRIS RAF⁴⁰⁸.

- 1973**
 Birth of Tomos EARTHROWL¹⁵⁵ on 26 February.
 Death of Lily May (aka Doris) LLOYD [EVANS]⁶³⁸ on 22 April.
 Death of Charles LLOYD⁶³⁷.
 Birth of Lynette WILLIAMS¹⁷⁸.
 Death of Thomas Clement J GRIFFITHS⁶¹⁵.
- 1974**
 Death of Alice May (Diddy) LLOYD⁵³⁶ in March, in Cherry Trees, Hay On Wye.
 Marriage of Graham C LLOYD³⁷¹ and Wendy LLOYD [WILLIAMS]³⁷² in Kington.
 Death of Danzey Evan LLOYD⁶⁴¹ in Cherry Trees, Hay On Wye.
 Birth of Marcus PRICE³⁹⁰.
 Marriage of Roger THOMAS²³⁷ and Rosemary THOMAS [BYWATER]²³⁶.
 Birth of Tamsin YORK [MORRIS]⁸².
 Death of Catherine (Kitty) LLOYD⁶⁴⁸.
- 1975**
 Birth of Amanda Louise NEWTON¹⁹⁰ on 2 January.
 Birth of James Edward EARTHROWL¹⁵⁶ on 7 April.
 Marriage of Elwyn John LLOYD³⁷⁹ and Jane LLOYD [HYATT]³⁸⁰ on 19 April.
 Birth of Paul WILLIAMS¹⁷³.
 Marriage of Ian PHILLIPS³⁸¹ and Pamela PHILLIPS [SPAREY]³⁸².
- 1976**
 Death of Doris BYWATER [WATKINS]⁴⁰³ in Ludlow, Shropshire.
 Death of Hugh LLOYD⁶⁴⁵.
 Death of Gwendoline Gertrude WHITTALL [LLOYD]⁶²¹.
 Death of John (Jack ?) LLOYD⁶⁴⁹.
- 1977**
 Birth of Jamie PHILLIPS²⁰⁶.
 Marriage of Stephen Gareth LLOYD BSc, D.C³⁰⁶ and Juliet LLOYD [DENMAN] Grad Dip TH³⁰⁷ on 3 September, in Worthing.
 Birth of Kelly NEWTON [DAVIS]¹⁸⁹ on 25 October.
- 1978**
 Birth of Sarah Julia LLOYD²⁰² on 26 June.
 Birth of Owen BOWERS¹⁶.
 Death of Edith BYWATER [DAVIES]⁴⁰⁶.
 Birth of Ceri STEPHENS¹²⁹.
 Death of Edith Megan ROBERTS [STRATTON]⁴⁵⁹.
- 1979**
 Death of James LLOYD⁶⁵¹.
 Birth of Katherine (Kate) BOWERS¹⁷.
 Birth of Frances Isabel LLOYD²⁰⁴ on 10 October.
- 1980**
 Birth of Robert PHILLIPS²⁰⁷.
 Death of Susannah LLOYD [GODWIN]⁶⁴⁶.
- 1981**
 Birth of Huw Meredydd STEPHENS¹²⁴ in May, in Glamorganshire.
 Marriage of Christopher Iltyd LEWIS³¹⁹ and Janet LEWIS [ROBERTS-LEWIS]³¹⁸.
 Birth of James BOWERS¹⁸.
- 1982**
 Birth of Camilla LANE¹³⁵ on 25 June.
 Birth of Timothy LANE¹³⁴ on 25 June.
 Birth of Huw LEWIS²⁰.
 Death of Mercia Willoughby DAVIES [LLOYD]⁴³¹.
 Marriage of Colin PHILLIPS³⁸³ and Jane PHILLIPS [EDWARDS]³⁸⁴.
 Birth of Jocelyn Ruth LLOYD²⁰⁵ on 7 November.
- 1983**
 Birth of Megan Elizabeth ROBERTS-LEWIS¹⁵⁷ on 11 May.
 Birth of Peter PHILLIPS²⁰⁸.
- 1984**
 Marriage of David Philip John LLOYD CEng, CITP, MBCS., MAPM²⁹¹ and Maria Alexandra LLOYD [BUBEAR] RGN RMN²⁹² on 24 March, in St Luke's Chapel, Royal Naval Hospital Haslar, Gosport, Hants.
 Death of Herbert Arthur LLOYD - STEPHENS⁴³⁴ on 23 June.
 Death of Phyllis WILLIAMS [JAMES]⁵⁰⁶.
 Birth of Rhys LEWIS²¹.
 Marriage of Peter Adrian LLOYD³⁰⁸ and Catherine LLOYD [FOLEY]³⁰⁹ on 21 July, in Leominster Baptist Chapel.

- 1985**
 Birth of Eleanor Joy HOLLAND [LLOYD] LLB (Oxon), LLM¹⁵⁰ on 1 January, in Cardiff.
 Marriage of David Kingsley LLOYD⁴⁴⁹ and Susan M LLOYD [MURRAY]⁴⁵⁰ in March, in Northampton, UK.
 Birth of Timothy John ROBERTS-LEWIS¹⁵⁸ on 22 March.
 Birth of Benjamin Thomas Tristram HOLLAND MEng (Oxon)¹⁵¹ on 16 August, in Cambridge, UK.
 Marriage of Richard BOWS RAF (Retd)²⁹⁹ and Terri BOWS [EASTWOOD]³⁰⁰ on 7 September.
- 1986**
 Birth of Emily Rebekah LLOYD¹³⁶ on 19 January, in Southampton.
 Birth of Samuel Peter LLOYD¹⁵³ on 31 January, in Oxford, UK.
 Birth of Hugh David LLOYD³⁰² in February.
 Marriage of John H LEWIS³⁸⁵ and Lorraine LEWIS [PRICE]³⁸⁶ in June.
 Death of Alfred Cornelius PASSANT⁵⁷⁹.
 Birth of Rebecca PHILLIPS²¹⁰.
 Death of Laura LLOYD [KINGS]⁵⁹³ in Harpole, Northamptonshire.
 Marriage of Robin LEWIS²⁹⁸ and Kathryn Ann LEWIS [BOWS] BMedSci, BM, BS²⁹⁷ in July, in Newark.
 Birth of Sarah Louise BOWS¹⁴⁷ in August, in Mansfield, Nottinghamshire.
 Birth of Kathryn Louise LLOYD BA, MA¹⁵² on 19 November, in Cardiff.
- 1987**
 Birth of Jessica Alys Sykes [LLOYD]¹³⁷ on 4 March, in Fareham, Hampshire.
 Death of Edward HARRIS⁴¹⁴.
 Birth of Kelly BROWN²³.
 Birth of Rhiannon DORWOOD²⁷.
 Birth of Benjamin Thomas LEWIS¹⁴⁴ in July, in Poole.
 Marriage of Winston Barrie MORGAN³⁶⁰ and Nancy C MORGAN [TAYLOR]³⁶¹ in July.
- 1988**
 Birth of Thomas MORGAN¹⁸⁴ on 24 March.
 Birth of Jacob Kingsley LLOYD³⁰³.
 Birth of Daniel PHILLIPS²¹¹.
 Birth of Rebecca Catherine FARMER⁵⁴ in Shrewsbury, UK.
 Birth of Elinor LEWIS²².
- 1989**
 Birth of Laura Anne BOWS¹⁴⁸ in February, in Aylesbury Vale.
 Birth of Jessica Helen LLOYD²⁰³ on 14 May.
 Birth of Matthew MORGAN¹⁸⁵ on 22 May.
 Death of Evan Rice LLOYD⁵²¹.
 Birth of Megan DORWOOD²⁸.
 Death of Adah Margaret BYWATER⁴⁰⁴.
 Death of Naomi MORRIS [BYWATER]⁴⁰⁷.
 Death of Sarah Janet STRATTON [LLOYD]⁵⁹⁸ on 24 September.
 Birth of Victoria Alexandra LLOYD¹³⁹ on 11 October, in Fareham, Hampshire.
 Birth of Cerian ROBERTS-LEWIS¹⁵⁹ on 17 October.
 Birth of Rhiannon Jayne LEWIS¹⁴⁵ in November, in Poole.
 Death of Trevor Glyn DAVIES⁴¹⁶ in November, in Herefordshire.
- 1990**
 Birth of Bethan Laura LLOYD³⁰⁴ in April.
 Marriage of Roderick MACLACHLAN⁸¹ and Julia MACLACHLAN [MORRIS]⁸⁰.
 Birth of Katy BACE⁴⁶.
 Birth of David PRITCHETT⁴³.
 Death of Eva PUGH [GRIFFITHS]⁶¹³.
- 1991**
 Marriage of John WHITTALL⁴⁸⁰ and Lynn WHITTALL [FITZPATRICK]⁴⁸¹.
 Birth of Anna BROWN²⁴.
 Birth of Mathew James FARMER⁵⁵ in Shrewsbury, UK.
 Death of Edmund DREW³⁹¹.
 Marriage of Gareth EVANS¹¹⁹ and Lowri Angharad EVANS [STEPHENS]¹¹⁸ in August, in South Glamorgan.
- 1992**
 Birth of Ivor BACE⁴⁷.
 Death of Mona LLOYD⁵³⁵.
 Birth of Anneli Rachel LEWIS¹⁴⁶ in August, in Shrewsbury, UK.
 Marriage of Aron EVANS¹²³ and Brengain Gwenllian EVANS [STEPHENS]¹²² in September, in South Glamorgan.
 Marriage of Roger BYWATER²⁵¹ and Ms. BYWATER²⁵² in about 1992.
- 1993**
 Marriage of Peter Geoffrey LLOYD²⁹³ and Karen Margaret LLOYD [DAWE]²⁹⁴ on 3 April, in Lew Trenchard, Devon.
 Death of Mabel LLOYD [KINGS]⁵⁹⁷ on 12 May.

1993 (Continued)

Birth of Nicola MORGAN¹⁸⁶ on 31 May.
 Birth of Robin BROWN²⁶.
 Birth of Mark BROWN²⁵.
 Birth of Nicola Christina BOWS¹⁴⁹.
 Death of John Arthur STRATTON⁴⁵⁷.
 Death of Robert David BYWATER⁴¹¹.
 Birth of Elan Meredydd EVANS³⁴.

1994

Marriage of Donald George KNIGHTON Reverend³¹⁷ and Gwenllian KNIGHTON [ROBERTS]³¹⁶ in February.
 Death of Constance Minnie DAVIES [BYWATER]⁴¹⁵ in February, in Leominster, UK.
 Marriage of Sebastian BYWATER⁶⁵ and Caroline BYWATER [ANDERSON]⁶⁶.
 Birth of Alice Victoria BYWATER⁸.
 Death of Alma LLOYD - STEPHENS [SYMES]⁴³⁵.
 Birth of Chloe Jane SKYRME¹⁹⁸ on 22 August.
 Death of Annie Matilda (Nan) PRITCHETT [EVES]⁴³⁷ on 25 December.

1996

Birth of Edward MORGAN¹⁸⁷ on 31 May.
 Birth of Rhiannon Wynn EVANS³⁵.
 Birth of John PRITCHETT⁴⁴ in September.

1997

Death of John LLOYD⁴⁴³ on 17 January, in Market Harborough.
 Burial of John LLOYD⁴⁴³ on 27 January, in Kibworth Cemetry, Leicestershire.
 Marriage of Andrew Robert LLOYD RAF²⁹⁵ and Cheryl Esther LLOYD [DUGGAN]²⁹⁶ on 28 June, in All Saints Church, Longhope, Gloucestershire.
 Birth of Gwern Arthur Rhys EVANS³⁶.
 Birth of Richard David SKYRME¹⁹⁹ on 5 December.

1998

Birth of Eleanor Ann WILLIAMS²⁰⁰ on 30 January.
 Birth of Benjamin David BYWATER⁹.
 Death of Gwendoline Dilys PICKERSGILL [LLOYD]⁴²⁵.
 Marriage of Richard Roger THOMAS⁷⁸ and Gwendoline THOMAS [RODERICK]⁷⁹ in November, in Brecknock, UK.
 Birth of Kezia Catherine Faith LLOYD¹⁵⁴ on 21 December, in Taunton, UK.

1999

Birth of John James LLOYD¹⁴⁰ on 1 June, in Cheltenham.
 Birth of Martha Glain EVANS²⁹.
 Death of Henry Charles LLOYD⁵²³.
 Death of Doris PHILLIPS [LLOYD]⁵⁴⁰ in August.
 Birth of Jack Rhys WILLIAMS²⁰¹ on 1 November.
 Birth of Bethany Esther LLOYD¹⁴² on 21 December, in Witney, Oxford.

2000

Death of Joyce Sarah HARRIS [BYWATER]⁴¹³.
 Divorce of David EARTHROWL³¹⁴ and Bronwen Dorothy STRATTON³¹³.
 Death of Derek BROWN²⁷².
 Death of Aubrey PRITCHETT⁴³⁸ on 16 August.

2001

Marriage of John BUNTING³¹⁵ and Bronwen Dorothy STRATTON³¹³.
 Death of Murial Gladys LLOYD⁴³⁶.
 Marriage of Christopher YORK⁸³ and Tamsin YORK [MORRIS]⁸².
 Marriage of Geraint DAY¹²¹ and Heledd Melangell DAY [STEPHENS]¹²⁰ in August, in Cardiff.
 Birth of Lillie Belle Unknown⁵⁶ on 7 November.

2002

Birth of Gwenno Angaharad DAY³² in May, in Pontypridd.
 Birth of Megan WILLIAMS⁵⁰.
 Birth of Louise Joan BYWATER¹⁰.
 Death of Sidney Walter Gordon LLOYD⁴⁵⁴ on 18 October, in Leominster, UK.

2003

Death of Robert Owen ROBERTS⁴⁶⁰ in May.
 Death of Hugh LLOYD⁵³⁸ on 7 June.
 Marriage of Gordon MENHENNICK³¹² and Christine Elizabeth MENHENNICK [STRATTON]³¹¹.
 Birth of Josie LLOYD¹⁴³ on 20 September.
 Birth of Naomi Ruth LLOYD¹⁴¹ on 21 September, in Melton Mowbray.

2004

Death of Jack SINCLAIR⁴⁴⁶ on 15 January, in Leeds.

2004 (Continued)

- Death of Ethel Elizabeth LLOYD⁵²⁷ on 27 May.
- Birth of Begw Angaharad EVANS³⁰.
- Birth of Elis Rhys EVANS³¹.
- Birth of Luned Rhys EVANS³⁷.
- Death of John BYWATER²²⁶.
- Marriage of Donald BURCHILL²⁷³ and Muriel Doreen LLOYD²⁷¹.

2005

- Birth of Gethin Emrys DAY³³ in January.
- Death of Anne LLOYD [PHILLIPS]⁶⁵² on 1 March.
- Death of Dorothy Mary LLOYD⁵³¹ on 6 April.

2006

- Death of Ruth JAMES [BYWATER]²²⁸.

2007

- Death of Mary JAMES⁵⁰⁸.

2008

- Death of Heather Joy LLOYD³¹⁰ on 23 February, in Hereford, UK.
- Birth of Menna Llwyd EVANS³⁸ on 7 September.

2010

- Birth of Monica Rose BOWS⁴⁸ on 6 February.

2012

- Marriage of Mathew Sykes¹³⁸ and Jessica Alys Sykes [LLOYD]¹³⁷ on 6 September, in Bolton.

7. INDEX OF INDIVIDUALS

<u>Ref.</u>	<u>Tree</u>	<u>Name (Relationship)</u>
84	37	UNKNOWN, Mr. (John's five-times-great-grandson).
85	37 Ms. (John's five-times-great-granddaughter).
509	122 Mr. (John's great-great-great-granddaughter's husband).
179	23 Mr. (John's five-times-great-granddaughter's husband).
87	39 Mr. (John's five-times-great-grandson).
175	21 Mr. (John's five-times-great-granddaughter's husband).
578	140 Mr. (John's great-great-granddaughter's husband).
88	39 Ms. (John's five-times-great-granddaughter).
19	8 Bethan Nerys (John's six-times-great-granddaughter).
537	 Gordon Rogers (John's great-great-great-granddaughter's husband).
49	21 Jamie (John's six-times-great-grandson).
2	 Kirsten (John's six-times-great-granddaughter's husband).
56	26 Lillie Belle (John's six-times-great-granddaughter).
51	23 Rhys (John's six-times-great-grandson).
180	70	AWAAD [FARMER], Theresa Louise (John's five-times-great-granddaughter).
53	24	AWAAD, Aymen (John's six-times-great-grandson).
181	24 Mohammed Osman M (John's five-times-great-granddaughter's husband).
52	24 Omar (John's six-times-great-grandson).
132	52	BACE [PRITCHETT], Jill (John's five-times-great-granddaughter).
133	19	BACE, Gordon (John's five-times-great-granddaughter's husband).
47	19 Ivor (John's six-times-great-grandson).
46	19 Katy (John's six-times-great-granddaughter).
343	118	BADEN POWELL, Rebecca (John's four-times-great-granddaughter).
342	118 Steven (John's four-times-great-grandson).
470	148	BASTIN [GRIFFITHS], Lesley M (John's great-great-great-granddaughter).
471		BASTIN, Mr. (John's great-great-great-granddaughter's husband).
324	110	BLANDFORD [JONES], Ann (John's four-times-great-granddaughter).
166	65	BLANDFORD, Henry (John's five-times-great-grandson).
167	65 Jane (John's five-times-great-granddaughter).
325	65 Timothy (John's four-times-great-granddaughter's husband).
165	65 Toby (John's five-times-great-grandson).
212	81	BOUNDS ? [LEWIS], Kerry (John's five-times-great-granddaughter).
213	27	BOUNDS ?, Stephen (John's five-times-great-granddaughter's husband).
57	27	BOUNDS, Bethany (John's six-times-great-granddaughter).
59	27 Courtenay (John's six-times-great-granddaughter).
58	27 Kieran (John's six-times-great-grandson).
497	152	BOWEN [POWELL], Jeanette (John's great-great-great-granddaughter).
341	117	BOWEN, Clive (John's four-times-great-grandchild).
498	117 Gilbert Samuel (John's great-great-great-granddaughter's husband).
340	117 Roger (John's four-times-great-grandson).
108	49	BOWERS [BROWN], Jeanne (John's five-times-great-granddaughter).
18	7	BOWERS, James (John's six-times-great-grandson).
17	7 Katherine (Kate) (John's six-times-great-granddaughter).
16	7 Owen (John's six-times-great-grandson).
109	7 Stewart (John's five-times-great-granddaughter's husband).
300	58	BOWS [EASTWOOD], Terri (John's four-times-great-grandson's wife).
447	143	BOWS [LLOYD], Annie Mabel (Nancy), BA (John's great-great-great-granddaughter).
301	104	BOWS, Charles Edward Lloyd, MA (John's four-times-great-grandson).
148	58 Laura Anne (John's five-times-great-granddaughter).
48	20 Monica Rose (John's six-times-great-granddaughter).
149	58 Nicola Christina (John's five-times-great-granddaughter).
448	104 Raymond George (Bill), BA (John's great-great-great-granddaughter's husband).
299	104 Richard, RAF (Retd), Wng Cdr (John's four-times-great-grandson).
147	58 Sarah Louise (John's five-times-great-granddaughter).
114	10	BROWN [BAGLEY], Margaret (John's five-times-great-grandson's wife).
24	10	BROWN, Anna (John's six-times-great-granddaughter).
110	49 Carol (John's five-times-great-granddaughter).
272	49 Derek (John's four-times-great-granddaughter's husband).
23	10 Kelly (John's six-times-great-granddaughter).
25	10 Mark (John's six-times-great-grandson).
115	49 Nigel (John's five-times-great-grandson).
26	11 Robin (John's six-times-great-grandson).
113	49 Wynn (John's five-times-great-grandson).

Ref.	Tree	Name (Relationship)
315		BUNTING, John (John's four-times-great-granddaughter's husband).
273		BURCHILL, Donald (John's four-times-great-granddaughter's husband).
66	3	BYWATER [ANDERSON], Caroline (John's five-times-great-grandson's wife).
249	40	BYWATER [COXON], Sue (John's four-times-great-grandson's wife).
406	86	BYWATER [DAVIES], Edith (John's great-great-great-grandson's wife).
400	84	BYWATER [ELLIS], Phyllis (John's great-great-great-grandson's wife).
235	34	BYWATER [JONES], Kate (John's four-times-great-grandson's wife).
570	164	BYWATER [LLOYD], Ada Agnes (John's great-great-granddaughter).
566	164 Sarah Rosa (John's great-great-granddaughter).
218	28	BYWATER [MARTIN], Joan S (John's four-times-great-grandson's wife).
410	88	BYWATER [MCLELLAN MILLAR], Ishobel (John's great-great-great-grandson's wife).
412	89	BYWATER [NOTT], Mary (John's great-great-great-grandson's wife).
61	1	BYWATER [PRIEST], Susan (John's five-times-great-grandson's wife).
231	32	BYWATER [SCOTT], May (John's four-times-great-grandson's wife).
399	83	BYWATER [THOMAS], Mary Elizabeth (John's great-great-great-grandson's wife).
403	85	BYWATER [WATKINS], Doris (John's great-great-great-grandson's wife).
246		BYWATER, Ms. (John's four-times-great-grandson's wife).
252	 Ms. (John's four-times-great-grandson's wife).
404	136 Adah Margaret (John's great-great-great-granddaughter).
8	3 Alice Victoria (John's six-times-great-granddaughter).
70	30 Anna Louise (John's five-times-great-granddaughter).
9	3 Benjamin David (John's six-times-great-grandson).
402	136 Caleb James (John's great-great-great-grandson).
225	84 Daphne (John's four-times-great-granddaughter).
89	40 David (John's five-times-great-grandson).
4	1 Emma Jane (John's six-times-great-granddaughter).
250	89 Geoffrey (John's four-times-great-grandson).
90	40 Gillian (John's five-times-great-granddaughter).
69	30 James (John's five-times-great-grandson).
5	1 James Edward (John's six-times-great-grandson).
234	86 John (John's four-times-great-grandson).
248	89 John (John's four-times-great-grandson).
571	 John (John's great-great-granddaughter's husband).
405	136 John (aka Jack) (John's great-great-great-grandson).
224	84 John Thomas (John's four-times-great-grandson).
226	85 John, Dr (John's four-times-great-grandson).
247	39 Linda (John's four-times-great-grandson's wife).
227	30 Louise (John's four-times-great-grandson's wife).
10	3 Louise Joan (John's six-times-great-granddaughter).
241	88 Murray Lloyd (John's four-times-great-grandson).
73	32 Owen (John's five-times-great-grandson).
242	37 Pamela (John's four-times-great-grandson's wife).
223	84 Phyllis Anne (John's four-times-great-granddaughter).
77	34 Rachel (John's five-times-great-granddaughter).
62	28 Rebecca (John's five-times-great-granddaughter).
398	136 Richard (John's great-great-great-grandson).
238	86 Richard (John's four-times-great-grandson).
76	34 Richard (John's five-times-great-grandson).
567	136 Richard (John's great-great-granddaughter's husband).
217	83 Richard David (John's four-times-great-grandson).
245	88 Richard Lloyd (John's four-times-great-grandson).
60	28 Richard Mathew (John's five-times-great-grandson).
1	1 Richard William (John's six-times-great-granddaughter).
411	136 Robert David (John's great-great-great-grandson).
230	85 Robin, BVMS, PhD, Dr (John's four-times-great-grandson).
251	89 Roger (John's four-times-great-grandson).
401	136 Rosa Mary (John's great-great-great-granddaughter).
65	28 Sebastian (John's five-times-great-grandson).
74	32 Simon (John's five-times-great-grandson).
409	136 Thomas (John's great-great-great-grandson).
3	1 Thomas David (John's six-times-great-grandson).
243	88	CLIFFORD [BYWATER], Judith Lloyd (John's four-times-great-granddaughter).
244	38	CLIFFORD, Peter (John's four-times-great-granddaughter's husband).

<u>Ref.</u>	<u>Tree</u>	<u>Name (Relationship)</u>
86	38	CLIFFORD, Thomas (John's five-times-great-grandson).
125	51	CORRIE [STEPHENS], Sian (John's five-times-great-granddaughter).
126	16	CORRIE, Clive (John's five-times-great-granddaughter's husband).
39	16 Imogen (John's six-times-great-granddaughter).
40	16 Isobel (John's six-times-great-granddaughter).
415	136	DAVIES [BYWATER], Constance Minnie (John's great-great-great-granddaughter).
581	167	DAVIES [JAMES], Elizabeth Ann (Lizzie) (John's great-great-granddaughter).
741	190	DAVIES [LLOYD], Ann (John's granddaughter).
561	164 Elizabeth (John's great-great-granddaughter).
431	139 Mercia Willoughby (John's great-great-great-granddaughter).
493	151	DAVIES [POWELL], Edith Margaret (John's great-great-great-granddaughter).
462	147	DAVIES [PUGH], Joyce Margaret (John's great-great-great-granddaughter).
582		DAVIES, Mr. (John's great-great-granddaughter's husband).
463	 Mr. (John's great-great-great-granddaughter's husband).
259	43 Ms. (John's four-times-great-grandson's wife).
432	99 Mr. (John's great-great-great-granddaughter's husband).
687	182 Anne (John's great-granddaughter).
98	43 Ben (John's five-times-great-grandson).
99	43 Bethan (John's five-times-great-granddaughter).
257	91 Charles (John's four-times-great-grandson).
258	 Clare (John's four-times-great-grandson's wife).
690	182 Edward (John's great-grandson).
280	99 James (John's four-times-great-grandson).
689	182 James (John's great-grandson).
494	115 Jeffrey (John's great-great-great-granddaughter's husband).
742	182 John (John's granddaughter's husband).
685	182 John (John's great-grandson).
688	182 Lloyd (John's great-grandson).
335	115 Richard (John's four-times-great-grandson).
336	115 Roderick (John's four-times-great-grandson).
686	182 Thomas (John's great-grandson).
416	91 Trevor Glyn (John's great-great-great-granddaughter's husband).
562	 William Edward (John's great-great-granddaughter's husband).
120	50	DAY [STEPHENS], Heledd Melangell (John's five-times-great-granddaughter).
121	14	DAY, Geraint (John's five-times-great-granddaughter's husband).
33	14 Gethin Emrys (John's six-times-great-grandson).
32	14 Gwenno Angaharad (John's six-times-great-granddaughter).
116	49	DORWOOD [BROWN], Claire (John's five-times-great-granddaughter).
117	12	DORWOOD, Mr. (John's five-times-great-granddaughter's husband).
28	12 Megan (John's six-times-great-granddaughter).
27	12 Rhianon (John's six-times-great-granddaughter).
559	164	DREW [LLOYD], Margaret (John's great-great-granddaughter).
394	134	DREW, Danzey (John's great-great-great-grandson).
391	134 Edmund (John's great-great-great-grandson).
560	134 Edmund Danzey (John's great-great-granddaughter's husband).
395	134 Elizabeth Mary (John's great-great-great-granddaughter).
393	134 Gladys (John's great-great-great-granddaughter).
392	134 Marjorie (John's great-great-great-granddaughter).
396	134 Minnie Sophia (John's great-great-great-grandson).
519	155	DUGGAN [LLOYD], Emily Maud (John's great-great-great-granddaughter).
365	126	DUGGAN, Jean (John's four-times-great-granddaughter).
364	126 John (John's four-times-great-grandson).
520	126 John (Jack) E (John's great-great-great-granddaughter's husband).
314	61	EARTHROWL, David (John's four-times-great-granddaughter's husband).
156	61 James Edward (John's five-times-great-grandson).
155	61 Tomos (John's five-times-great-grandson).
752	190	EVANS [LLOYD], Sarah (John's granddaughter).
122	50	EVANS [STEPHENS], Brengain Gwenllian (John's five-times-great-granddaughter).
118	50 Lowri Angharad (John's five-times-great-granddaughter).
735		EVANS, Albert (John's great-granddaughter's husband).
123	15 Aron (John's five-times-great-granddaughter's husband).
30	13 Begw Angaharad (John's six-times-great-granddaughter).
34	15 Elan Meredydd (John's six-times-great-granddaughter).

<u>Ref.</u>	<u>Tree</u>	<u>Name (Relationship)</u>
31	13	EVANS, Elis Rhys (John's six-times-great-grandson).
119	13 Gareth (John's five-times-great-granddaughter's husband).
36	15 Gwern Arthur Rhys (John's six-times-great-grandson).
729	188 Hugh Lloyd (John's great-grandson).
725	188 James (John's great-grandson).
753	188 James (John's granddaughter's husband).
728	188 John (John's great-grandson).
726	188 John (John's great-grandson).
37	15 Luned Rhys (John's six-times-great-grandson).
734	188 Marianne (John's great-granddaughter).
29	13 Martha Glain (John's six-times-great-granddaughter).
38	15 Menna Llwyd (John's six-times-great-granddaughter).
35	15 Rhiannon Wynn (John's six-times-great-granddaughter).
727	188 Sarah Ann (John's great-granddaughter).
730	188 Thomas (John's great-grandson).
731	188 William (John's great-grandson).
585	168	EVES [LLOYD], Sophia Matilda (Tillie) (John's great-great-granddaughter).
586	141	EVES, Ernest Edward (John's great-great-granddaughter's husband).
355	122	FARMER [JAMES], Rita Hazel (John's four-times-great-granddaughter).
183	25	FARMER [TITLEY], Jane (John's five-times-great-grandson's wife).
182	70	FARMER, Adrian Oliver (John's five-times-great-grandson).
356	70 Herbert Oliver (John's four-times-great-granddaughter's husband).
55	25 Mathew James (John's six-times-great-grandson).
54	25 Rebecca Catherine (John's six-times-great-granddaughter).
219	83	FISHER [BYWATER], Darinda M (John's four-times-great-granddaughter).
220		FISHER, Brian A S (John's four-times-great-granddaughter's husband).
696	184	FRANCIS [LLOYD], Mary Ann (Polly) (John's great-granddaughter).
697		FRANCIS, Thomas (John's great-granddaughter's husband).
604	169	GITTOES [LLOYD], Ada Marion (John's great-great-granddaughter).
605		GITTOES, James (John's great-great-granddaughter's husband).
555	163	GOODWIN [MEREDITH], Annie (John's great-great-granddaughter).
556		GOODWIN, Mr. (John's great-great-granddaughter's husband).
692	171	GRIFFITHS [DAVIES], Fortune (John's great-grandson's wife).
260	91 Julie (John's four-times-great-granddaughter).
618	149	GRIFFITHS [EVANS], Maud (John's great-great-grandson's wife).
743	190	GRIFFITHS [LLOYD], Mary (John's granddaughter).
261	44	GRIFFITHS, Mr. (John's four-times-great-granddaughter's husband).
617	171 Arthur (John's great-great-grandson).
264	 Barry (John's four-times-great-granddaughter's husband).
744	183 John (John's granddaughter's husband).
472	148 Peter (John's great-great-great-grandson).
691	183 Thomas (John's great-grandson).
615	171 Thomas Clement J (John's great-great-grandson).
100	44 Tim (John's five-times-great-grandson).
475	148	GRIFFOTHS [GRIFFITHS], Pamela M (John's great-great-great-granddaughter).
476		GRIFFOTHS, Mr. (John's great-great-great-granddaughter's husband).
452	144	HARDWICK [LLOYD], Kathleen (John's great-great-great-granddaughter).
305	106	HARDWICK, David (John's four-times-great-grandson).
453	106 Tom (John's great-great-great-granddaughter's husband).
413	136	HARRIS [BYWATER], Joyce Sarah (John's great-great-great-granddaughter).
256	42	HARRIS [JONES], Kathleen M (John's four-times-great-grandson's wife).
429	138	HARRIS [LLOYD], Margaret Maisie (John's great-great-great-granddaughter).
430	98	HARRIS, Mr. (John's great-great-great-granddaughter's husband).
278	98 Mr. (John's four-times-great-grandson).
279	98 Mr. (John's four-times-great-grandson).
91	41 Anne (John's five-times-great-granddaughter).
96	42 Edward (John's five-times-great-grandson).
94	41 Edward (John's five-times-great-grandson).
414	90 Edward (John's great-great-great-granddaughter's husband).
253	90 Edward (John's four-times-great-grandson).
97	42 Jane (John's five-times-great-granddaughter).
93	41 Janet (John's five-times-great-granddaughter).
92	41 Louise (John's five-times-great-granddaughter).

<u>Ref.</u>	<u>Tree</u>	<u>Name (Relationship)</u>
254	41	HARRIS, Margaret (John's four-times-great-grandson's wife).
95	42 Richard (John's five-times-great-grandson).
255	90 Thomas L (John's four-times-great-grandson).
344	119	HARRISON [POWELL], Jane (John's four-times-great-granddaughter).
168	66	HARRISON, Ben (John's five-times-great-grandson).
345	66 Karl (John's four-times-great-granddaughter's husband).
169	66 Tia (John's five-times-great-granddaughter).
150	59	HOLLAND [LLOYD], Eleanor Joy, LLB (Oxon), LLM (John's five-times-great-granddaughter).
151		HOLLAND, Benjamin Thomas Tristram, MEng (Oxon) (John's five-times-great-granddaughter's husband).
503	152	ILES [POWELL], Ms. (John's great-great-great-granddaughter).
504	120	ILES, Derek (John's great-great-great-granddaughter's husband).
349	120 Judith (John's four-times-great-granddaughter).
350	120 Lois (John's four-times-great-granddaughter).
485	151	INGRAM [POWELL], Gwendoline Jane (Babs) (John's great-great-great-granddaughter).
486	111	INGRAM, George James (John's great-great-great-granddaughter's husband).
326	111 Jenny (John's four-times-great-granddaughter).
228	85	JAMES [BYWATER], Ruth (John's four-times-great-granddaughter).
677	181	JAMES [LLOYD], Elizabeth (Bessie) (John's great-granddaughter).
627	174 Sarah Jane (Janey) (John's great-great-granddaughter).
464	147	JAMES [PUGH], Betty (John's great-great-great-granddaughter).
465		JAMES, Mr. (John's great-great-great-granddaughter's husband).
72	31 Alan (John's five-times-great-grandson).
505	153 Albert (John's great-great-great-grandson).
511	153 Dennis (John's great-great-great-grandson).
628	153 Henry (Harold) (John's great-great-granddaughter's husband).
678	167 James (John's great-granddaughter's husband).
229	31 Jeff (John's four-times-great-granddaughter's husband).
71	31 Jenny (John's five-times-great-granddaughter).
508	153 Mary (John's great-great-great-granddaughter).
323	64	JONES [EVANS], Nicola (John's four-times-great-grandson's wife).
321	63	JONES [MORGAN], Sandra (John's four-times-great-grandson's wife).
483	151	JONES [POWELL], Dorothy May (John's great-great-great-granddaughter).
160	63	JONES, Charlotte (John's five-times-great-granddaughter).
484	110 Harold Henry (John's great-great-great-granddaughter's husband).
164	64 Harriet (John's five-times-great-granddaughter).
162	64 Jessica (John's five-times-great-granddaughter).
320	110 John (John's four-times-great-grandson).
161	63 Rebecca (John's five-times-great-granddaughter).
322	110 Robert (John's four-times-great-grandson).
163	64 Sophia (John's five-times-great-granddaughter).
316	109	KNIGHTON [ROBERTS], Gwennlian (John's four-times-great-granddaughter).
317		KNIGHTON, Donald George, Reverend (John's four-times-great-granddaughter's husband).
440	102	LANE [BALLINGER], Irene (John's great-great-great-grandson's wife).
587	168	LANE [LLOYD], Elizabeth Anne (Annie) (John's great-great-granddaughter).
135	53	LANE, Camilla (John's five-times-great-granddaughter).
287	102 Philip (John's four-times-great-grandson).
288	53 Susan (John's four-times-great-grandson's wife).
588	142 Thomas (John's great-great-granddaughter's husband).
134	53 Timothy (John's five-times-great-grandson).
439	142 Tom Evan (John's great-great-great-grandson).
297	104	LEWIS [BOWS], Kathryn Ann, BMedSci , BM, BS, Dr (John's four-times-great-granddaughter).
111	49	LEWIS [BROWN], Alison (John's five-times-great-granddaughter).
221	83	LEWIS [BYWATER], Margaret (John's four-times-great-granddaughter).
477	149	LEWIS [GRIFFITHS], Pamela (John's great-great-great-granddaughter).
542	159	LEWIS [LLOYD], Elizabeth Nancy (John's great-great-great-granddaughter).
386	81	LEWIS [PRICE], Lorraine (John's four-times-great-grandson's wife).
318	109	LEWIS [ROBERTS-LEWIS], Janet (John's four-times-great-granddaughter).
112	9	LEWIS, Mr. (John's five-times-great-granddaughter's husband).
146	57 Anneli Rachel (John's five-times-great-granddaughter).
144	57 Benjamin Thomas (John's five-times-great-grandson).
358	123 Carol (John's four-times-great-granddaughter).
319	62 Christopher Illtyd, Reverend (John's four-times-great-granddaughter's husband).
510	123 David (John's great-great-great-granddaughter's husband).

<u>Ref.</u>	<u>Tree</u>	<u>Name (Relationship)</u>
22	9	LEWIS, Elinor (John's six-times-great-granddaughter).
222	29 Gordon G (John's four-times-great-granddaughter's husband).
357	123 Gwyndaf (John's four-times-great-grandson).
20	9 Huw (John's six-times-great-grandson).
478	 John (John's great-great-great-granddaughter's husband).
543	132 John (John's great-great-great-granddaughter's husband).
385	132 John H (John's four-times-great-grandson).
145	57 Rhiannon Jayne (John's five-times-great-granddaughter).
21	9 Rhys (John's six-times-great-grandson).
68	29 Richard J (John's five-times-great-grandson).
298	57 Robin (John's four-times-great-granddaughter's husband).
67	29 Stehphen K (John's five-times-great-grandson).
214	81 William (John's five-times-great-grandson).
435	100	LLOYD - STEPHENS [SYMES], Alma (John's great-great-great-grandson's wife).
434	140	LLOYD - STEPHENS, Herbert Arthur (John's great-great-great-grandson).
524	128	LLOYD [BAKER], Enid A (John's great-great-great-grandson's wife).
758		LLOYD [BARKER], Mary (John's daughter-in-law).
718	178	LLOYD [BOND], Emma Eliza (John's great-grandson's wife).
292	54	LLOYD [BUBEAR], Maria Alexandra, RGN RMN (John's four-times-great-grandson's wife).
657	161	LLOYD [CLARKE], Eva May (John's great-great-grandson's wife).
671	164	LLOYD [CONNOP], Margaret (John's great-grandson's wife).
761	191	LLOYD [DAVIES], Anne (John's wife).
516	125 Dorothy Clare (John's great-great-great-grandson's wife).
676	166 Mary Ann (John's great-grandson's wife).
294	55	LLOYD [DAWE], Karen Margaret (John's four-times-great-grandson's wife).
756	190	LLOYD [DEAKINS (DAKIN)], Ann (John's daughter-in-law).
307	59	LLOYD [DENMAN], Juliet, Grad Dip TH, Reverend (John's four-times-great-grandson's wife).
704	174	LLOYD [DREW], Harriett (John's great-grandson's wife).
296	56	LLOYD [DUGGAN], Cheryl Esther (John's four-times-great-grandson's wife).
369	73	LLOYD [DURRELL], Irene (John's four-times-great-grandson's wife).
640	157	LLOYD [EDITH], Frances (John's great-great-grandson's wife).
638	156	LLOYD [EVANS], Lily May (aka Doris) (John's great-great-grandson's wife).
751	187 Sarah (John's grandson's wife).
309	60	LLOYD [FOLEY], Catherine (John's four-times-great-grandson's wife).
646	159	LLOYD [GODWIN], Susannah (John's great-great-grandson's wife).
378	77	LLOYD [GOUGH], Sarah Marie (John's four-times-great-grandson's wife).
748	185	LLOYD [GRIFFITHS], Jane (John's grandson's wife).
650		LLOYD [HAMER], Mary Eileen (John's great-great-grandson's wife).
636	155 Sarah Ann (John's great-great-grandson's wife).
574	138	LLOYD [HARLEY], Florence (John's great-great-grandson's wife).
712	176	LLOYD [HARVARD], Sarah Ann (John's great-grandson's wife).
682	169	LLOYD [HILL], Clara (John's great-grandson's wife).
380	78	LLOYD [HYATT], Jane (John's four-times-great-grandson's wife).
595	144	LLOYD [JONES], Catherine (John's great-great-grandson's wife).
642	158 Gertrude (John's great-great-grandson's wife).
593	143	LLOYD [KINGS], Laura (John's great-great-grandson's wife).
597	145 Mabel (John's great-great-grandson's wife).
658	162	LLOYD [LEWIS], Beatrice Eva (John's great-great-grandson's wife).
750	186 Elizabeth (John's grandson's wife).
630	 Patty (John's great-great-grandson's wife).
738	180	LLOYD [MAINWARING], Ann (John's grandson's wife).
551	163	LLOYD [MEREDITH], Elizabeth Ann (Eliza) (John's great-great-granddaughter).
444	103	LLOYD [MILLER], Beryl Kathryn (John's great-great-great-grandson's wife).
680	168	LLOYD [MILWARD], Sarah (John's great-grandson's wife).
539	130	LLOYD [MORRIS], Eva Grace (John's great-great-great-grandson's wife).
450	105	LLOYD [MURRAY], Susan M (John's great-great-great-grandson's wife).
576		LLOYD [OWEN], Sarah Maude (John's great-great-grandson's wife).
652	160	LLOYD [PHILLIPS], Anne (John's great-great-grandson's wife).
714	177	LLOYD [POWELL], Catherine (John's great-grandson's wife).
674	165 Martha (John's great-grandson's wife).
632	154	LLOYD [PRITCHARD], Margaret Jane (John's great-great-grandson's wife).
746	184	LLOYD [PROBERT], Sarah (John's grandson's wife).
706	175	LLOYD [REES], Margaret (John's great-grandson's wife).

<u>Ref.</u>	<u>Tree</u>	<u>Name (Relationship)</u>
702	173	LLOYD [REES], Rachel (John's great-grandson's wife).
455	107	LLOYD [SIMMONS], Peggy (John's great-great-great-grandson's wife).
372	74	LLOYD [WILLIAMS], Wendy (John's four-times-great-grandson's wife).
575	139	LLOYD [WILLOUGHBY], Emily Elizabeth (John's great-great-grandson's wife).
583	168	LLOYD, Adeliza Ann (John's great-great-granddaughter).
377	130 Alan Hugh (John's four-times-great-grandson).
589	168 Alice (John's great-great-granddaughter).
719	187 Alice (John's great-granddaughter).
536	158 Alice May (Diddy) (John's great-great-great-granddaughter).
295	103 Andrew Robert, RAF, Wing Cdr (John's four-times-great-grandson).
580	166 Anne (John's great-great-granddaughter).
603	169 Annie Clara (John's great-great-granddaughter).
577	165 Annie Sophia (aka Nancy) (John's great-great-granddaughter).
548	162 Arther E (John's great-great-great-grandson).
722	187 Arthur (John's great-grandson).
552	 Benjamin (John's great-great-granddaughter's husband).
304	105 Bethan Laura (John's four-times-great-granddaughter).
142	56 Bethany Esther (John's five-times-great-granddaughter).
363	125 Carmen (John's four-times-great-granddaughter).
191	73 Cassie (John's five-times-great-granddaughter).
648	175 Catherine (Kitty) (John's great-great-granddaughter).
590	168 Charles (John's great-great-grandson).
708	185 Charles (John's great-grandson).
637	174 Charles (John's great-great-grandson).
528	156 Charles G (John's great-great-great-grandson).
451	143 Christine Megan (John's great-great-great-granddaughter).
194	73 Christopher (John's five-times-great-grandson).
641	174 Danzey Evan (John's great-great-grandson).
754	191 David (John's son).
368	127 David Evan (John's four-times-great-grandson).
449	143 David Kingsley (John's great-great-great-grandson).
291	103 David Philip John, CEng, CITP, MBCS., MAPM (John's four-times-great-grandson).
456	145 Dilys (John's great-great-great-granddaughter).
442	143 Doreen Gladys (John's great-great-great-granddaughter).
531	156 Dorothy Mary (John's great-great-great-granddaughter).
600	168 Edith (John's great-great-granddaughter).
550	162 Edith A (John's great-great-great-granddaughter).
529	156 Edward (Ted) A (John's great-great-great-grandson).
713	187 Edward Lewis (John's great-grandson).
659	176 Elizabeth (John's great-great-granddaughter).
602	169 Elizabeth Florence (John's great-great-granddaughter).
379	130 Elwyn John (John's four-times-great-grandson).
660	177 Emily (John's great-great-granddaughter).
136	54 Emily Rebekah (John's five-times-great-granddaughter).
527	156 Ethel Elizabeth (John's great-great-great-granddaughter).
717	187 Evan (John's great-grandson).
681	181 Evan (John's great-grandson).
521	155 Evan Rice (John's great-great-great-grandson).
596	168 Evan Sidney (John's great-great-grandson).
601	169 Evan Thomas, FRSM, MBMA, MRSI, Dr (John's great-great-grandson).
204	78 Frances Isabel (John's five-times-great-granddaughter).
197	74 Gareth (John's five-times-great-grandson).
591	168 Gladys (John's great-great-granddaughter).
371	128 Graham C (John's four-times-great-grandson).
533	157 Graham Hugh (John's great-great-great-grandson).
310	107 Heather Joy (John's four-times-great-granddaughter).
523	155 Henry Charles (John's great-great-great-grandson).
663	178 Herbert (John's great-great-grandson).
763	 Hester (John's sister-in-law).
765	192 Hester (John's sister).
522	127 Hilda (John's great-great-great-grandson's wife).
549	162 Hilda E (John's great-great-great-granddaughter).
530	156 Hilde (John's great-great-great-granddaughter).

<u>Ref.</u>	<u>Tree</u>	<u>Name (Relationship)</u>
573	165	LLOYD, Hugh (John's great-great-grandson).
709	186 Hugh (John's great-grandson).
749	190 Hugh (John's grandson).
673	181 Hugh (John's great-grandson).
755	191 Hugh (John's son).
592	168 Hugh (John's great-great-grandson).
705	185 Hugh (John's great-grandson).
645	175 Hugh (John's great-great-grandson).
538	159 Hugh (John's great-great-great-grandson).
639	174 Hugh (John's great-great-grandson).
557	164 Hugh Caleb (John's great-great-grandson).
302	105 Hugh David (John's four-times-great-grandson).
433	139 Hugh John Willoughby (John's great-great-great-grandson).
303	105 Jacob Kingsley (John's four-times-great-grandson).
736	189 James (John's grandson).
635	174 James (John's great-great-grandson).
651	175 James (John's great-great-grandson).
703	185 James (John's great-grandson).
517	155 James Hamer (John's great-great-great-grandson).
558	164 James Thomas (Tom) (John's great-great-grandson).
767	192 Jane (John's mother).
195	74 Jane (John's five-times-great-granddaughter).
619	172 Jane (John's great-great-granddaughter).
694	184 Jeffrey Thomas (John's great-grandson).
203	77 Jessica Helen (John's five-times-great-granddaughter).
205	78 Jocelyn Ruth (John's five-times-great-granddaughter).
759	 John (John's nephew).
634	174 John (John's great-great-grandson).
710	187 John (John's great-grandson).
766	192 John (John's father).
667	180 John (John's great-grandson).
443	143 John (John's great-great-great-grandson).
737	190 John (John's grandson).
675	181 John (John's great-grandson).
701	185 John (John's great-grandson).
633	174 John (John's great-great-grandson).
649	175 John (Jack ?) (John's great-great-grandson).
565	164 John Evan (John's great-great-grandson).
140	55 John James (John's five-times-great-grandson).
760	192 John, of Brunnant (The subject of this report).
143	56 Josie (John's five-times-great-granddaughter).
152	59 Kathryn Louise, BA, MA (John's five-times-great-granddaughter).
154	60 Kezia Catherine Faith (John's five-times-great-granddaughter).
441	143 Laurence Walter Hugh, RAFVR, LAC (John's great-great-great-grandson).
661	178 Lillian (John's great-great-granddaughter).
532	156 Marian Jane (John's great-great-great-granddaughter).
715	187 Mary (John's great-granddaughter).
672	181 Mary (John's great-granddaughter).
653	176 Matthew John (John's great-great-grandson).
546	161 Mildred (John's great-great-great-granddaughter).
572	164 Minnie Gladys (John's great-great-granddaughter).
535	158 Mona (John's great-great-great-granddaughter).
436	140 Murial Gladys (John's great-great-great-granddaughter).
424	138 Muriel Annie (Dolly) (John's great-great-great-granddaughter).
271	95 Muriel Doreen (John's four-times-great-granddaughter).
141	55 Naomi Ruth (John's five-times-great-granddaughter).
518	 Norah (John's great-great-great-grandson's wife).
196	74 Paul (John's five-times-great-grandson).
362	125 Peggy (John's four-times-great-granddaughter).
308	107 Peter Adrian, Reverend (John's four-times-great-grandson).
293	103 Peter Geoffrey (John's four-times-great-grandson).
720	187 Price John (John's great-grandson).
695	184 Richard (John's great-grandson).

<u>Ref.</u>	<u>Tree</u>	<u>Name (Relationship)</u>
764	192	LLOYD, Richard (John's brother).
745	190 Richard (John's grandson).
370	128 Robert (John's four-times-great-grandson).
534	158 Roland (John's great-great-great-grandson).
547	161 Rosa J (John's great-great-great-granddaughter).
153	60 Samuel Peter (John's five-times-great-grandson).
693	184 Sarah Ann (John's great-granddaughter).
721	187 Sarah Ann (John's great-granddaughter).
202	77 Sarah Julia (John's five-times-great-granddaughter).
192	73 Sean (John's five-times-great-grandson).
454	145 Sidney Walter Gordon (John's great-great-great-grandson).
740	181 Sophia (John's grandson's wife).
193	73 Sophie (John's five-times-great-granddaughter).
306	107 Stephen Gareth, BSc, D.C (John's four-times-great-grandson).
670	181 Thomas (John's great-grandson).
711	187 Thomas (John's great-grandson).
757	191 Thomas (John's son).
707	185 Thomas (John's great-grandson).
762	192 Thomas (John's brother).
739	190 Thomas (John's grandson).
631	174 Thomas (John's great-great-grandson).
656	176 Thomas Hugh (John's great-great-grandson).
594	168 Thomas John (John's great-great-grandson).
139	54 Victoria Alexandra (John's five-times-great-granddaughter).
514	154 Vincent (John's great-great-great-grandson).
515	154 Walter (John's great-great-great-grandson).
629	174 William (John's great-great-grandson).
700	185 William (John's great-grandson).
647	175 William (John's great-great-grandson).
679	181 William (John's great-grandson).
662	178 William (John's great-great-grandson).
747	190 William (John's grandson).
716	187 William (John's great-grandson).
584	168 William Bayley (John's great-great-grandson).
620	173 William Henry (John's great-great-grandson).
80	36	MACLACHLAN [MORRIS], Julia (John's five-times-great-granddaughter).
81		MACLACHLAN, Roderick (John's five-times-great-granddaughter's husband).
311	108	MENHENNICK [STRATTON], Christine Elizabeth (John's four-times-great-granddaughter).
312		MENHENNICK, Gordon (John's four-times-great-granddaughter's husband).
668	181	MEREDITH [LLOYD], Ann (John's great-granddaughter).
723	187 Elizabeth (John's great-granddaughter).
724	179	MEREDITH, David Thomas (John's great-granddaughter's husband).
664	179 Eleanor Edith (John's great-great-granddaughter).
665	179 Hilda Elizabeth (John's great-great-granddaughter).
669	163 Samuel (John's great-granddaughter's husband).
553	163 Samuel (John's great-great-grandson).
554	163 Thomas (John's great-great-grandson).
666	179 Winifred Sarah (John's great-great-granddaughter).
512	153	MORGAN [JAMES], Margeurite J (John's great-great-great-granddaughter).
643	175	MORGAN [LLOYD], Margaret Jane (John's great-great-granddaughter).
683	181 Sarah Sophia (John's great-granddaughter).
361	71	MORGAN [TAYLOR], Nancy C (John's four-times-great-grandson's wife).
359	124	MORGAN, Austin Thomas James (John's four-times-great-grandson).
644	 Cliff (John's great-great-granddaughter's husband).
187	71 Edward (John's five-times-great-grandson).
611	170 Edward G (John's great-great-grandson).
610	170 Evan John Lloyd (John's great-great-grandson).
612	170 James H (John's great-great-grandson).
185	71 Matthew (John's five-times-great-grandson).
186	71 Nicola (John's five-times-great-granddaughter).
606	170 Sarah Anne (John's great-great-granddaughter).
184	71 Thomas (John's five-times-great-grandson).
513	124 Thomas A (John's great-great-great-granddaughter's husband).

<u>Ref.</u>	<u>Tree</u>	<u>Name (Relationship)</u>
684	170	MORGAN, William (John's great-granddaughter's husband).
609	170 William Thomas (John's great-great-grandson).
360	124 Winston Barrie (John's four-times-great-grandson).
407	136	MORRIS [BYWATER], Naomi (John's great-great-great-granddaughter).
240	36	MORRIS [EVANS], Vivien, Dr (John's four-times-great-grandson's wife).
408	87	MORRIS, Ira, RAF, Wing Cdr (John's great-great-great-granddaughter's husband).
239	87 Richard, Dr (John's four-times-great-grandson).
189		NEWTON [DAVIS], Kelly (John's five-times-great-grandson's wife).
366	127	NEWTON [LLOYD], Elizabeth Anne (John's four-times-great-granddaughter).
190	72	NEWTON, Amanda Louise (John's five-times-great-granddaughter).
188	72 Anthony Paul (John's five-times-great-grandson).
367	72 Roger John (John's four-times-great-granddaughter's husband).
732	188	PARRY [EVANS], Sarah Ann (John's great-granddaughter).
733		PARRY, William Jones (John's great-granddaughter's husband).
579		PASSANT, Alfred Cornelius (John's great-great-granddaughter's husband).
616	148	PEVERILL, Blanche (John's great-great-grandson's wife).
384	80	PHILLIPS [EDWARDS], Jane (John's four-times-great-grandson's wife).
698	184	PHILLIPS [LLOYD], Annie (John's great-granddaughter).
540	159 Doris (John's great-great-great-granddaughter).
382	79	PHILLIPS [SPAREY], Pamela (John's four-times-great-grandson's wife).
209	80	PHILLIPS, Carrie (John's five-times-great-granddaughter).
383	131 Colin (John's four-times-great-grandson).
211	80 Daniel (John's five-times-great-grandson).
699	 Edward Baker (John's great-granddaughter's husband).
381	131 Ian (John's four-times-great-grandson).
206	79 Jamie (John's five-times-great-grandson).
208	79 Peter (John's five-times-great-grandson).
210	80 Rebecca (John's five-times-great-granddaughter).
207	79 Robert (John's five-times-great-grandson).
541	131 Victor Evan (John's great-great-great-granddaughter's husband).
425	138	PICKERSGILL [LLOYD], Gwendoline Dilys (John's great-great-great-granddaughter).
274	96	PICKERSGILL, Mr. (John's four-times-great-grandson).
426	96 Mr. (John's great-great-great-granddaughter's husband).
654	176	PITT [LLOYD], Sarah Ann (John's great-great-granddaughter).
655		PITT, Harry Arthur, ? (John's great-great-granddaughter's husband).
488	112	POWELL [GORE], Enid (John's great-great-great-grandson's wife).
502	119	POWELL [LEWIS], Christine (John's great-great-great-grandson's wife).
625	173	POWELL [LLOYD], Edith Mary (John's great-great-granddaughter).
623	173 Jane Sophia (John's great-great-granddaughter).
525	155 Joan (John's great-great-great-granddaughter).
500	118 Mary (John's great-great-great-grandson's wife).
492	114	POWELL [PUGH], Ruth (John's great-great-great-grandson's wife).
467	147 Ruth (John's great-great-great-granddaughter).
468		POWELL, Mr. (John's great-great-great-granddaughter's husband).
334	114 Andrew (John's four-times-great-grandson).
348	119 Anna (John's four-times-great-granddaughter).
337	116 Christopher (John's four-times-great-grandson).
526	129 David (John's great-great-great-granddaughter's husband).
496	116 Eithel Pugh (John's great-great-great-granddaughter's husband).
329	112 Graham (John's four-times-great-grandson).
327	112 John (John's four-times-great-grandson).
482	151 Kathleen Mary (John's great-great-great-granddaughter).
491	151 Kenneth Charles (John's great-great-great-grandson).
495	152 Lena Mary (John's great-great-great-granddaughter).
339	116 Lorraine (John's four-times-great-granddaughter).
338	116 Lynette (John's four-times-great-granddaughter).
333	114 Margaret (John's four-times-great-granddaughter).
328	112 Philip (John's four-times-great-grandson).
501	152 Robert Lloyd (John's great-great-great-grandson).
624	151 Thomas John (John's great-great-granddaughter's husband).
487	151 Thomas John (John's great-great-great-grandson).
626	152 William Baden (John's great-great-granddaughter's husband).
499	152 William Owen (John's great-great-great-grandson).

<u>Ref.</u>	<u>Tree</u>	<u>Name (Relationship)</u>
232	85	PRICE [BYWATER], Sally (John's four-times-great-granddaughter).
544	160	PRICE [LLOYD], Margaret (John's great-great-great-granddaughter).
489	151	PRICE [POWELL], Elizabeth Rachel (John's great-great-great-granddaughter).
331	113	PRICE, David (John's four-times-great-grandson).
545	133 Edward (John's great-great-great-granddaughter's husband).
387	133 Edward (John's four-times-great-grandson).
75	33 James (John's five-times-great-grandson).
330	113 Lynda (John's four-times-great-granddaughter).
332	113 M (John's four-times-great-granddaughter).
390	133 Marcus (John's four-times-great-grandson).
233	33 Russell (John's four-times-great-granddaughter's husband).
490	113 William Mervyn (John's great-great-great-granddaughter's husband).
286	52	PRITCHETT [BEASLEY], Janet (John's four-times-great-grandson's wife).
437	141	PRITCHETT [EVES], Annie Matilda (Nan) (John's great-great-great-granddaughter).
438	101	PRITCHETT, Aubrey (John's great-great-great-granddaughter's husband).
285	101 Aubrey E Michael (John's four-times-great-grandson).
130	52 Bruce (John's five-times-great-grandson).
43	18 David (John's six-times-great-grandson).
131	18 Jane (John's five-times-great-grandson's wife).
44	18 John (John's six-times-great-grandson).
45	18 Sarah Jane (John's six-times-great-granddaughter).
613	171	PUGH [GRIFFITHS], Eva (John's great-great-granddaughter).
469	147	PUGH, Barbara (John's great-great-great-granddaughter).
614	147 David (John's great-great-granddaughter's husband).
461	147 Edward (Eddie) (John's great-great-great-grandson).
466	147 Margaret (John's great-great-great-granddaughter).
159	62	ROBERTS-LEWIS, Cerian (John's five-times-great-grandson).
157	62 Megan Elizabeth (John's five-times-great-granddaughter).
158	62 Timothy John (John's five-times-great-grandson).
568	164	ROBERTS [LLOYD], Ann Sophia (John's great-great-granddaughter).
418	92	ROBERTS [MASON], Doris (John's great-great-great-grandson's wife).
423	94	ROBERTS [PLAIN], Mona A (John's great-great-great-grandson's wife).
459	146	ROBERTS [STRATTON], Edith Megan (John's great-great-great-granddaughter).
421	93	ROBERTS [WILLIAMS], Annie (John's great-great-great-grandson's wife).
106	47	ROBERTS, Andrew William (John's five-times-great-grandson).
107	48 Andrew William (John's five-times-great-grandson).
270	94 Caleb Thomas (John's four-times-great-grandson).
268	93 Doreen (John's four-times-great-granddaughter).
419	137 Gladys Anne (John's great-great-great-granddaughter).
14	5 James (John's six-times-great-grandson).
15	6 James (John's six-times-great-grandson).
420	137 James Albert (John's great-great-great-grandson).
267	93 Joyce (John's four-times-great-granddaughter).
262	92 Maisie Annie (John's four-times-great-granddaughter).
269	93 Newton (John's four-times-great-grandson).
460	109 Robert Owen (John's great-great-great-granddaughter's husband).
422	137 William Caleb (John's great-great-great-grandson).
569	137 William Owen (John's great-great-granddaughter's husband).
417	137 William Thomas (John's great-great-great-grandson).
445	143	SINCLAIR [LLOYD], Laura Marjorie (John's great-great-great-granddaughter).
446		SINCLAIR, Jack, Dr (John's great-great-great-granddaughter's husband).
373	129	SKYRME [POWELL], Anita Jane (John's four-times-great-granddaughter).
198	75	SKYRME, Chloe Jane (John's five-times-great-granddaughter).
199	75 Richard David (John's five-times-great-grandson).
374	75 Richard Philip (John's four-times-great-granddaughter's husband).
473	148	SMITHERS [GRIFFITHS], Marjorie Sally (John's great-great-great-granddaughter).
474		SMITHERS, Mr. (John's great-great-great-granddaughter's husband).
63	28	STEPHENS [BYWATER], Olivia (John's five-times-great-granddaughter).
282	50	STEPHENS [MEREDITH], Ruth Wynn (John's four-times-great-grandson's wife).
284	51	STEPHENS [MORRIS], Margaret Patricia Ismay (John's four-times-great-grandson's wife).
128	17	STEPHENS, Alison (John's five-times-great-grandson's wife).
129	51 Ceri (John's five-times-great-granddaughter).
7	2 Edward (John's six-times-great-grandson).

Ref.	Tree	Name (Relationship)
41	17	STEPHENS, George (John's six-times-great-grandson).
124	50 Huw Meredydd (John's five-times-great-grandson).
283	100 Lloyd (John's four-times-great-grandson).
281	100 Meic, MA Dlitt (John's four-times-great-grandson).
127	51 Neil (John's five-times-great-grandson).
64	2 Peter j (John's five-times-great-granddaughter's husband).
6	2 Scott (John's six-times-great-grandson).
42	17 Thomas (John's six-times-great-grandson).
598	168	STRATTON [LLOYD], Sarah Janet (John's great-great-granddaughter).
458	108	STRATTON [MACAULAY], Hannah Heslop (John's great-great-great-grandson's wife).
599	146	STRATTON, Arthur (John's great-great-granddaughter's husband).
313	108 Bronwen Dorothy (John's four-times-great-granddaughter).
457	146 John Arthur (John's great-great-great-grandson).
137	54	SYKES [LLOYD], Jessica Alys (John's five-times-great-granddaughter).
138		SYKES, Mathew (John's five-times-great-granddaughter's husband).
427	138	TAIT [LLOYD], Kathleen Florence Martha (John's great-great-great-granddaughter).
428	97	TAIT, Mr. (John's great-great-great-granddaughter's husband).
277	97 Mr. (John's four-times-great-grandson).
276	97 Alan (John's four-times-great-grandson).
275	97 Jenny (John's four-times-great-granddaughter).
236	86	THOMAS [BYWATER], Rosemary (John's four-times-great-granddaughter).
79		THOMAS [RODERICK], Gwendoline (John's five-times-great-grandson's wife).
78	35	THOMAS, Richard Roger (John's five-times-great-grandson).
237	35 Roger (John's four-times-great-granddaughter's husband).
346	119	TUFT [POWELL], Clare (John's four-times-great-granddaughter).
170	67	TUFT, Eva (John's five-times-great-granddaughter).
172	67 Joel (John's five-times-great-grandson).
171	67 Sally (John's five-times-great-granddaughter).
347	67 Stephen (John's four-times-great-granddaughter's husband).
289	102	TURNER [LANE], Rachel (John's four-times-great-granddaughter).
290		TURNER, Robert (John's four-times-great-granddaughter's husband).
265	92	WEBB [ROBERTS], Elizabeth Mary (Betty) (John's four-times-great-granddaughter).
104	4	WEBB, Ms. (John's five-times-great-grandson's wife).
11	4 Mr. (John's six-times-great-grandson).
13	4 Mr. (John's six-times-great-grandson).
12	4 Mr. (John's six-times-great-grandson).
103	46 Alan (John's five-times-great-grandson).
266	46 David (John's four-times-great-granddaughter's husband).
105	46 Jane (John's five-times-great-granddaughter).
263	45	WHATELEY, Dr Tony (John's four-times-great-granddaughter's husband).
101	45 Julie Anne (John's five-times-great-granddaughter).
102	45 Phillipa Anne (John's five-times-great-granddaughter).
481		WHITTALL [FITZPATRICK], Lynn (John's great-great-great-grandson's wife).
621	173	WHITTALL [LLOYD], Gwendoline Gertrude (John's great-great-granddaughter).
622	150	WHITTALL, Ivor (John's great-great-granddaughter's husband).
480	150 John (John's great-great-great-grandson).
479	150 Mary (John's great-great-great-granddaughter).
506	153	WILLIAMS [JAMES], Phyllis (John's great-great-great-granddaughter).
563	164	WILLIAMS [LLOYD], Mary Ann (Polly) (John's great-great-granddaughter).
607	170	WILLIAMS [MORGAN], Mary Elizabeth (John's great-great-granddaughter).
375	129	WILLIAMS [POWELL], Kathryn Ann (John's four-times-great-granddaughter).
388	133	WILLIAMS [PRICE], Dawn (John's four-times-great-granddaughter).
354	69	WILLIAMS [WATKINS], Dilys (John's four-times-great-grandson's wife).
177	22	WILLIAMS, Ms. (John's five-times-great-grandson's wife).
608	 Mr. (John's great-great-granddaughter's husband).
376	76 Christopher John (John's four-times-great-granddaughter's husband).
389	82 David (John's four-times-great-granddaughter's husband).
200	76 Eleanor Ann (John's five-times-great-granddaughter).
216	82 Georgia (John's five-times-great-granddaughter).
353	121 Glyn (John's four-times-great-grandson).
201	76 Jack Rhys (John's five-times-great-grandson).
215	82 Jemimah (John's five-times-great-granddaughter).
351	121 Kenneth (Ken) (John's four-times-great-grandson).

<u>Ref.</u>	<u>Tree</u>	<u>Name (Relationship)</u>
174	69	WILLIAMS, Leslie (John's five-times-great-granddaughter).
178	69 Lynette (John's five-times-great-granddaughter).
397	135 Mary (John's great-great-great-granddaughter).
50	22 Megan (John's six-times-great-granddaughter).
176	69 Michael (John's five-times-great-grandson).
173	68 Paul (John's five-times-great-grandson).
507	121 Sid (John's great-great-great-granddaughter's husband).
352	68 Vera Lindsley (John's four-times-great-grandson's wife).
564	135 William (John's great-great-granddaughter's husband).
82	36	YORK [MORRIS], Tamsin (John's five-times-great-granddaughter).
83		YORK, Christopher (John's five-times-great-granddaughter's husband).